

REZYSTORY		KONDENSATORY	
	0,15W		25V
	0,25W		32V
	0,35W		63V
	0,5W		100V
	1W		160V
	2W		230V
	5W		400V
	5W REZYSTOR		630V
			1000V
			ceramiczny
			polistyrenowy
			poliestrowy

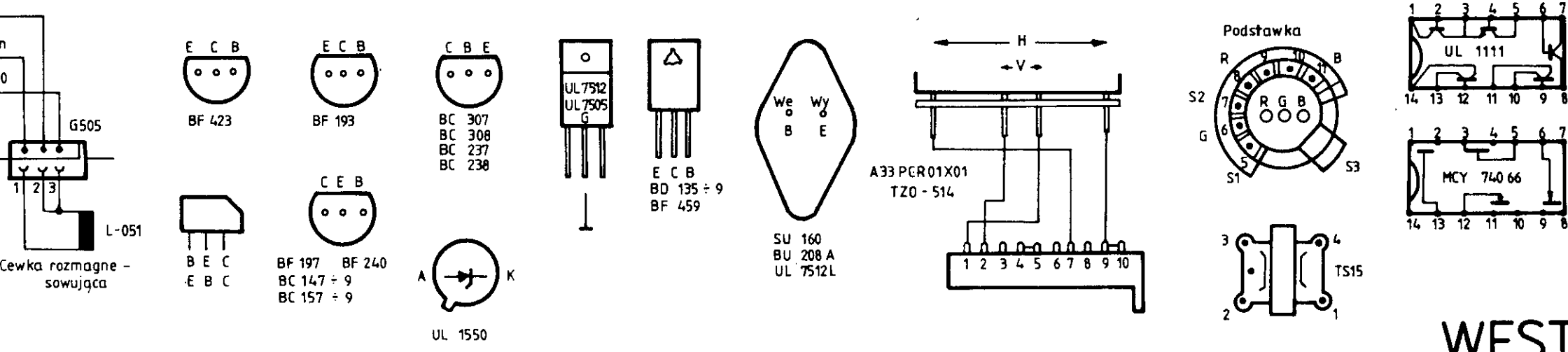

WESTA TC 201

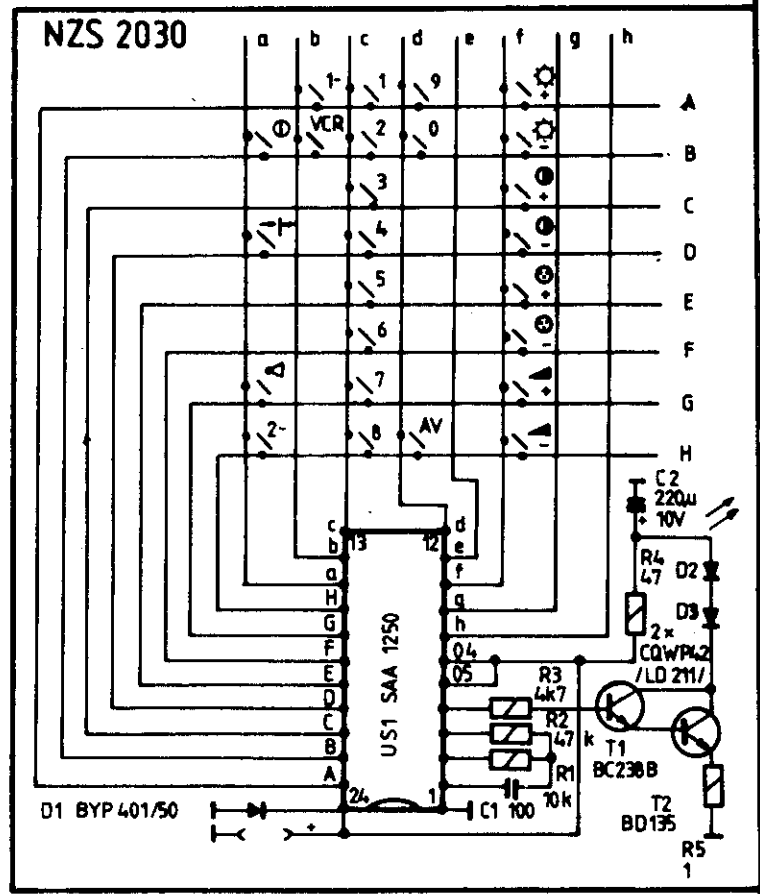
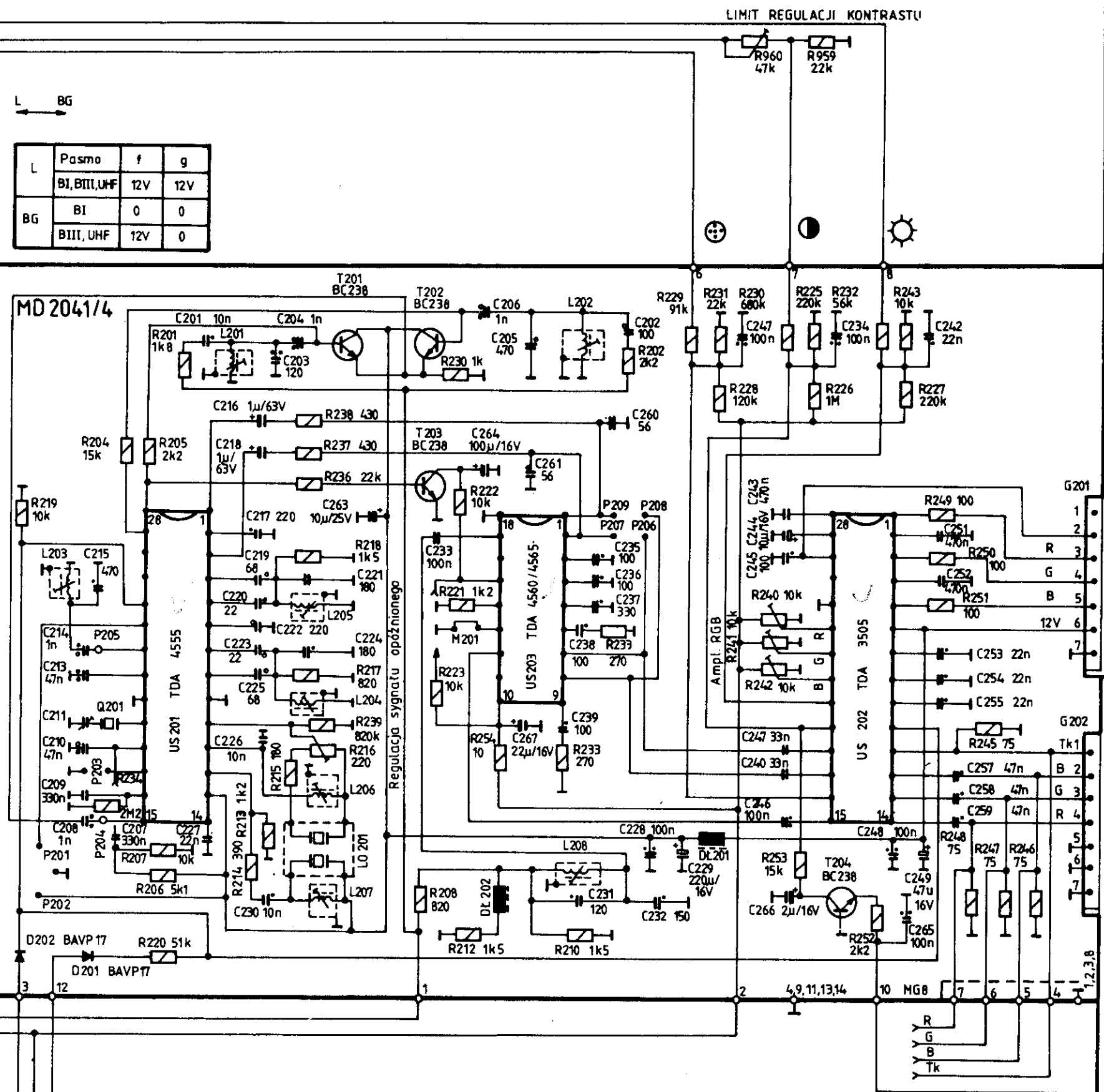
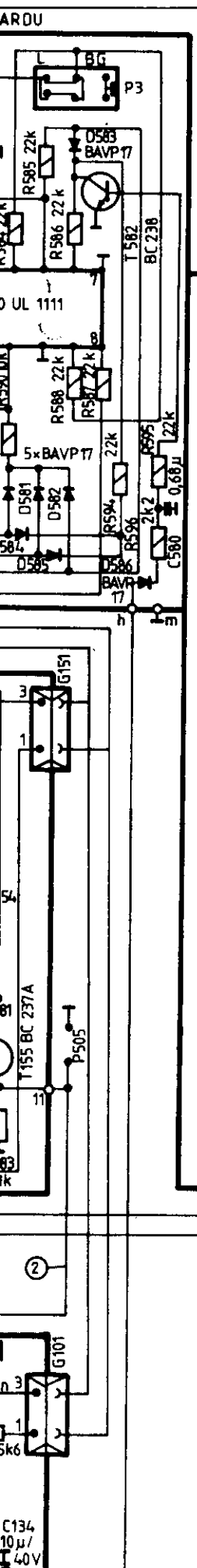

L	Pasmo	f	g
BI, BIII, UHF	12V	12V	
BG	BI	0	0
	BIII, UHF	12V	0

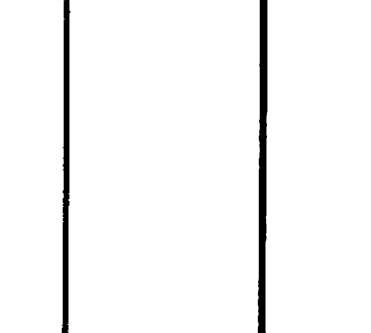
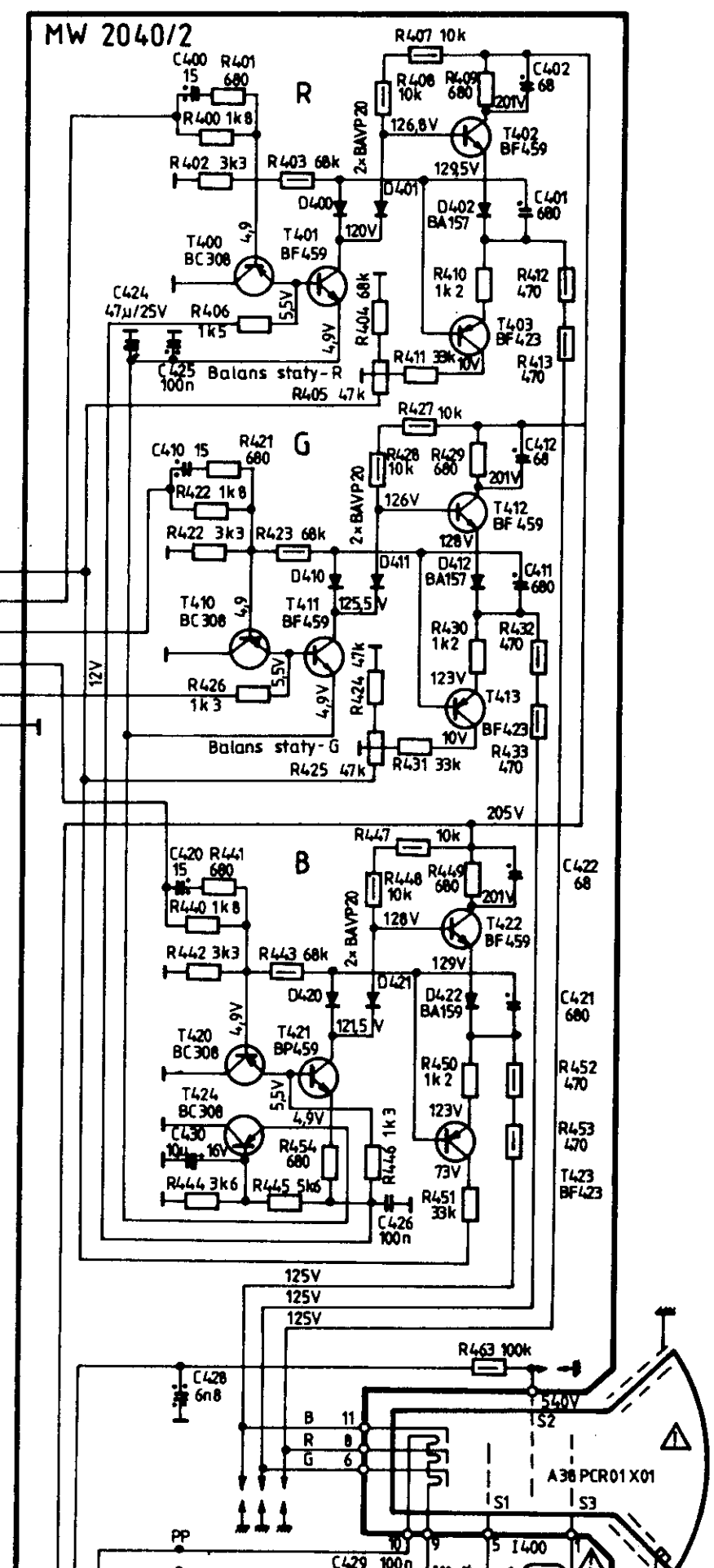
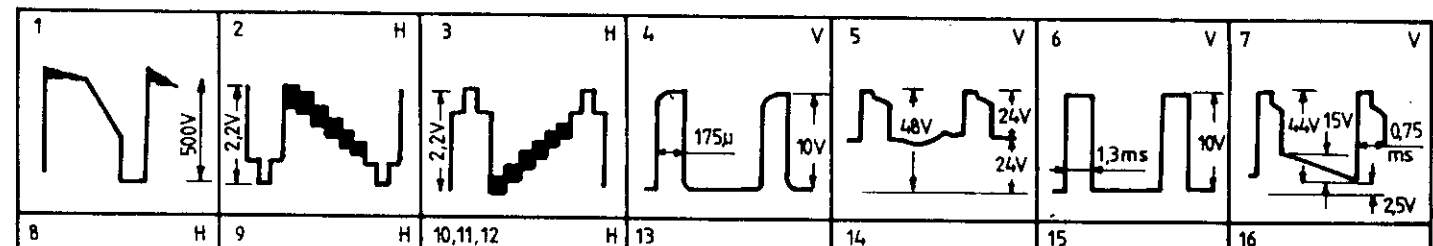

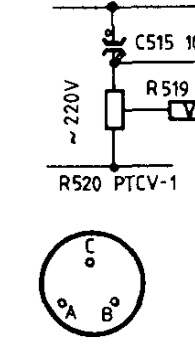
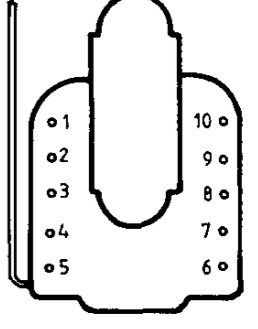
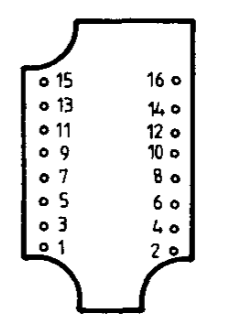
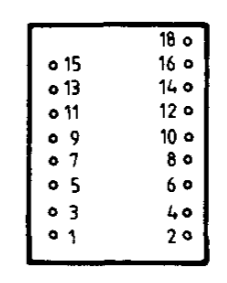
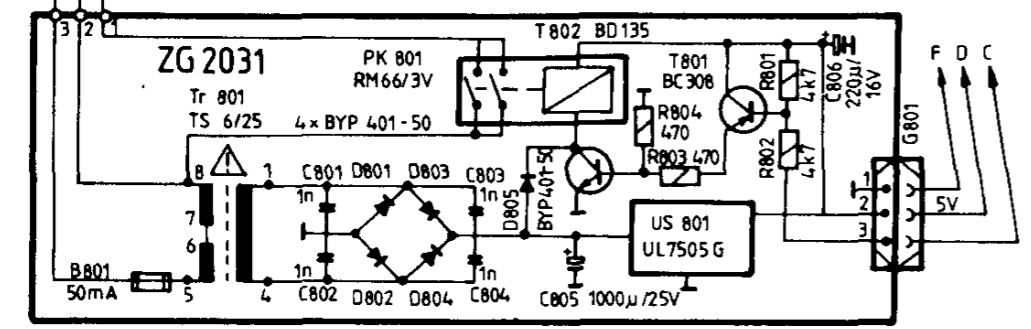
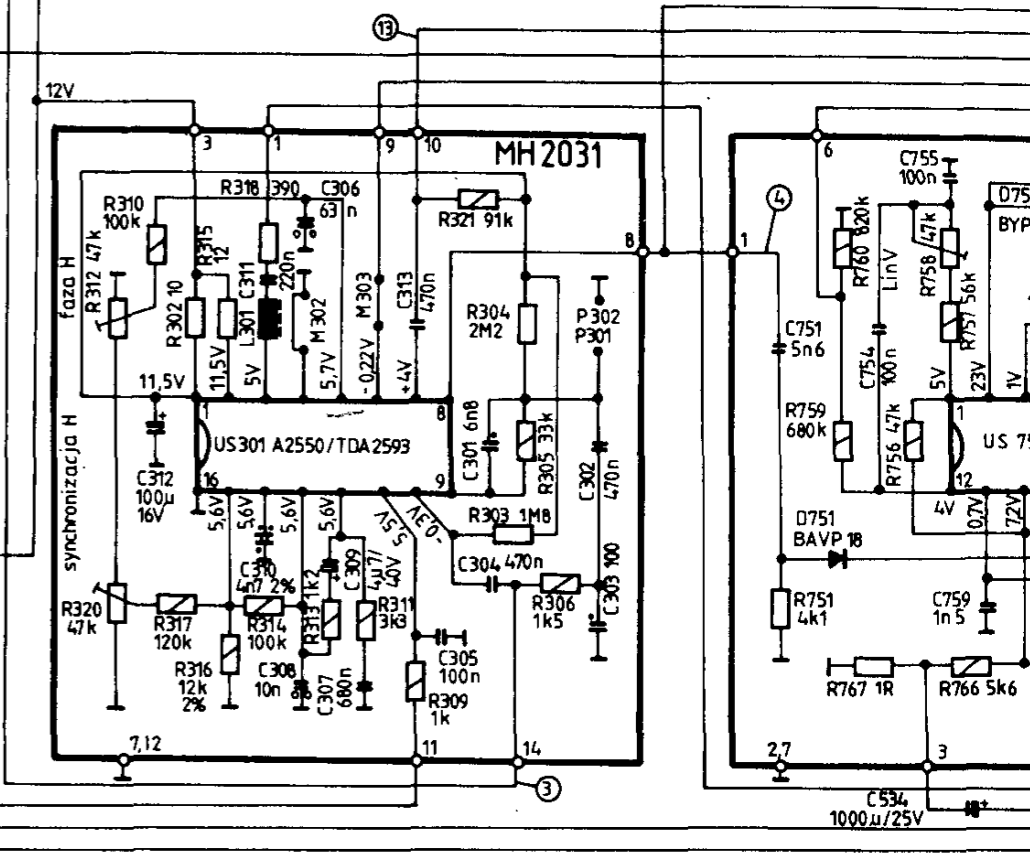
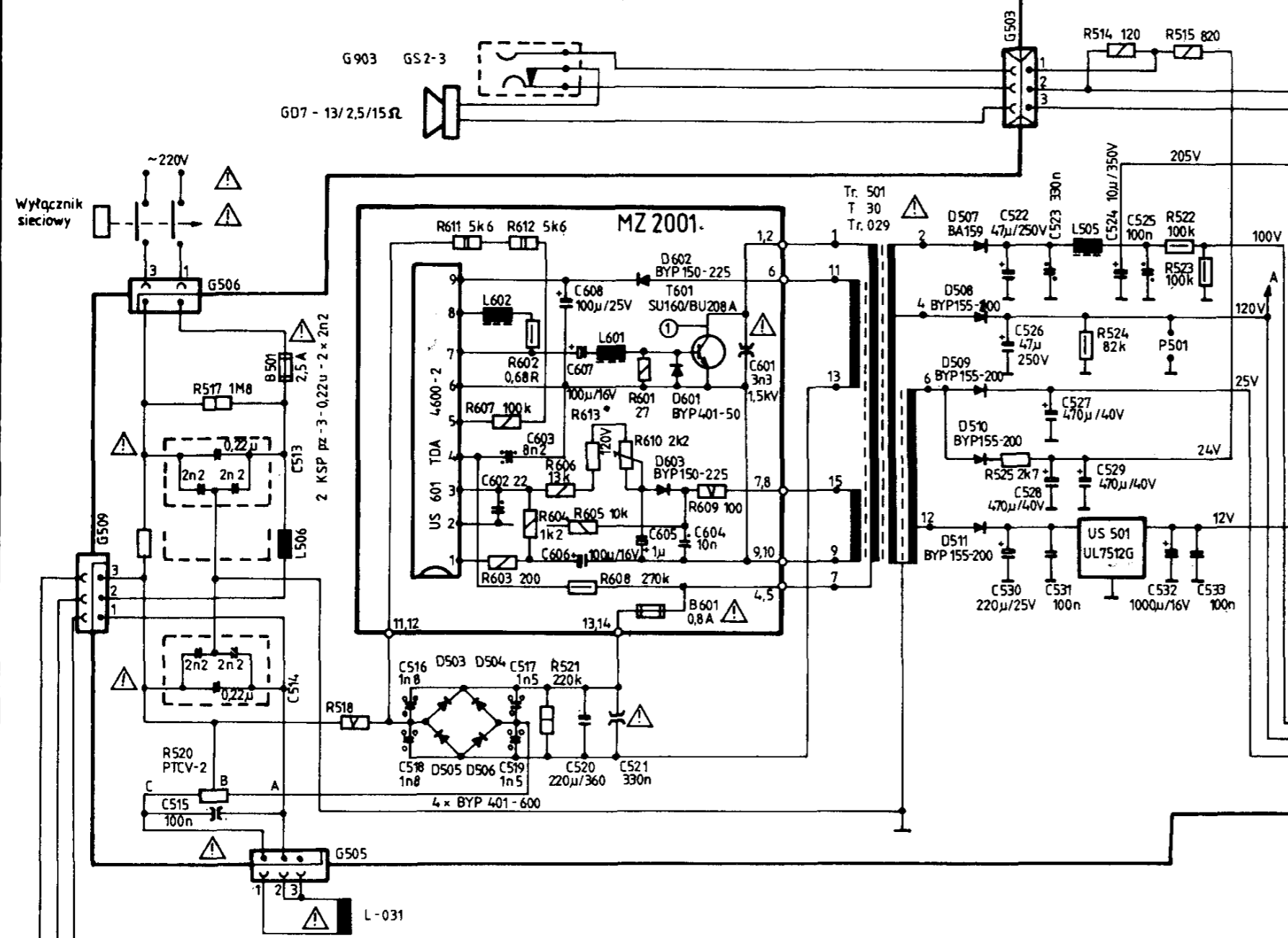
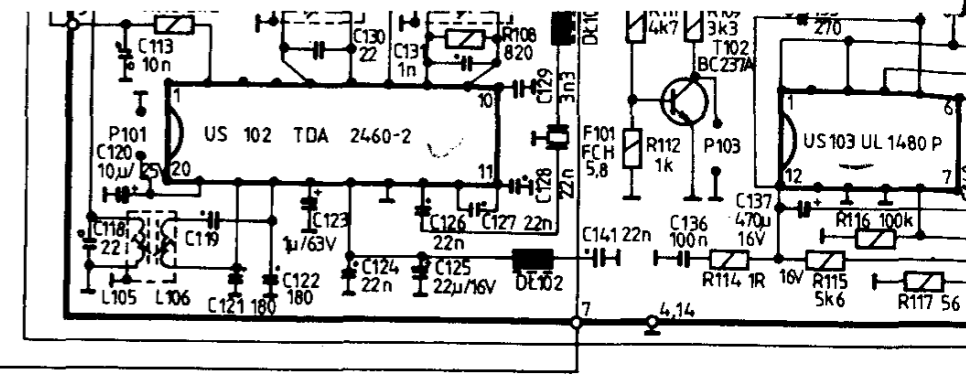
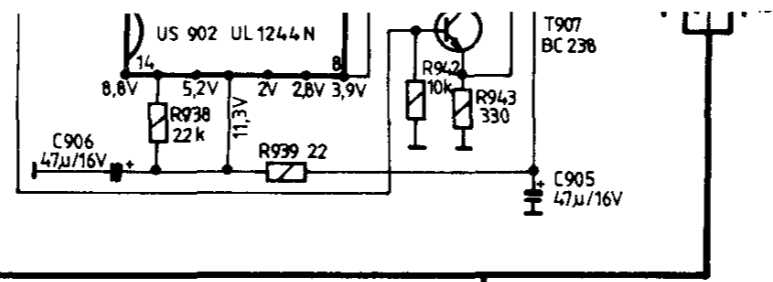
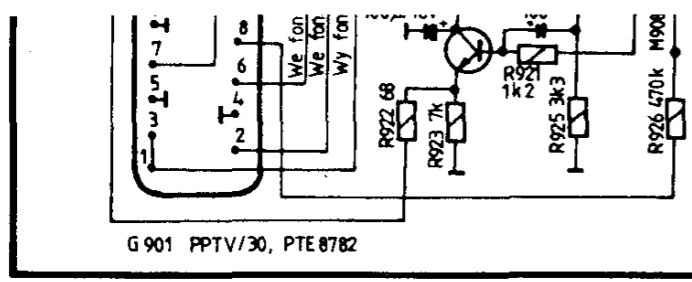

OZS 2030/4

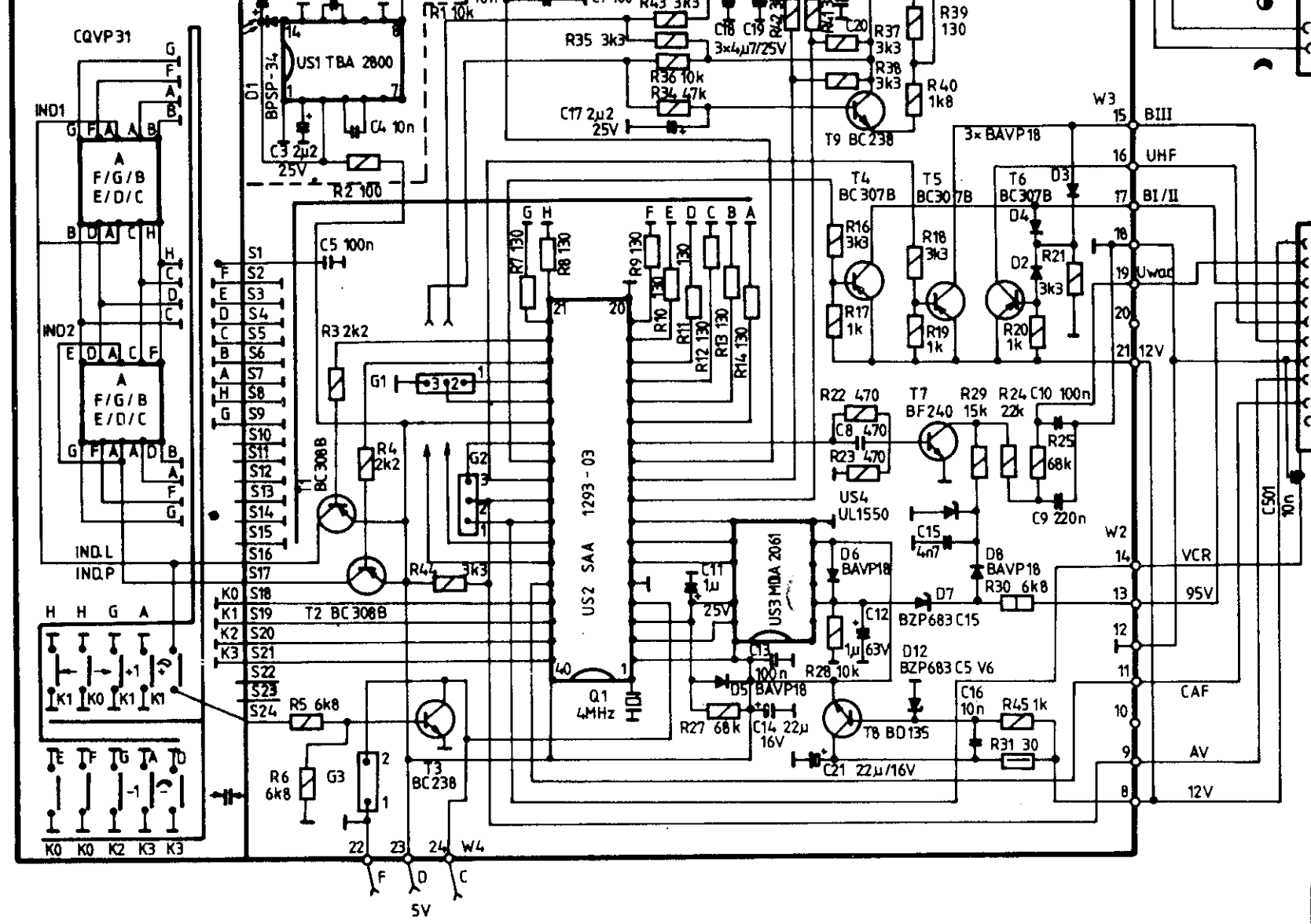

ME 2041/2

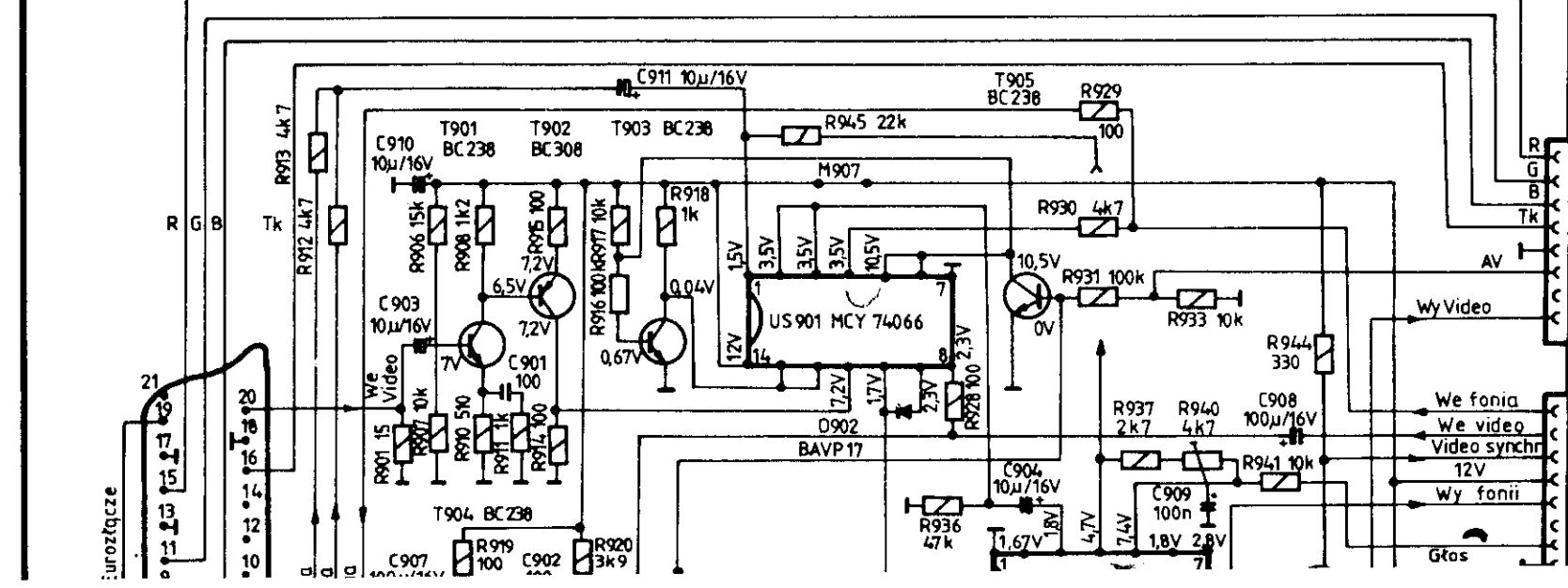

Z GM 801		0		12V		0		0 + 28V		12V		UHF	
1 + 9V		12V		0		0		12V		12V		BI/II	
0		0		12V		0		0		12V		BI/II	
CAG		BI/II		UHF		BI/II		Uwar.		12V		F.I.	

MP2021

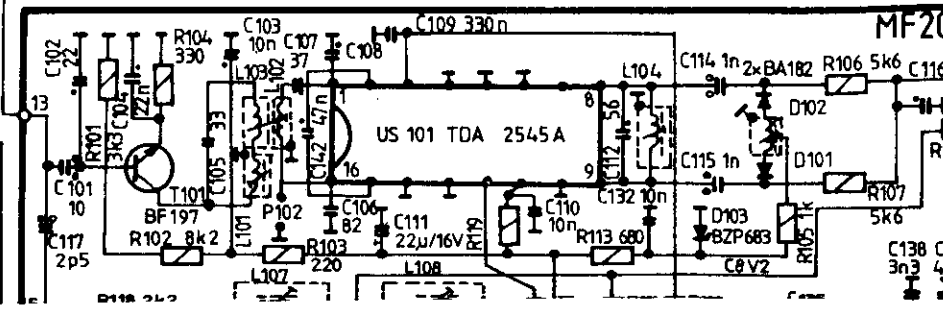
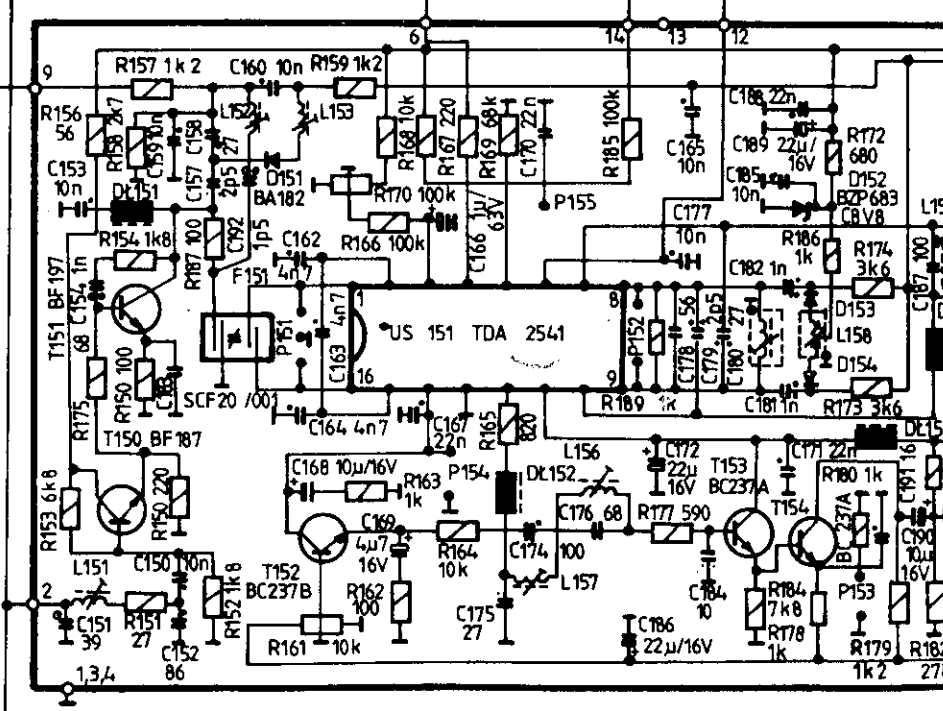

WYBÓR STAN
PS2001

