

### MG 1002

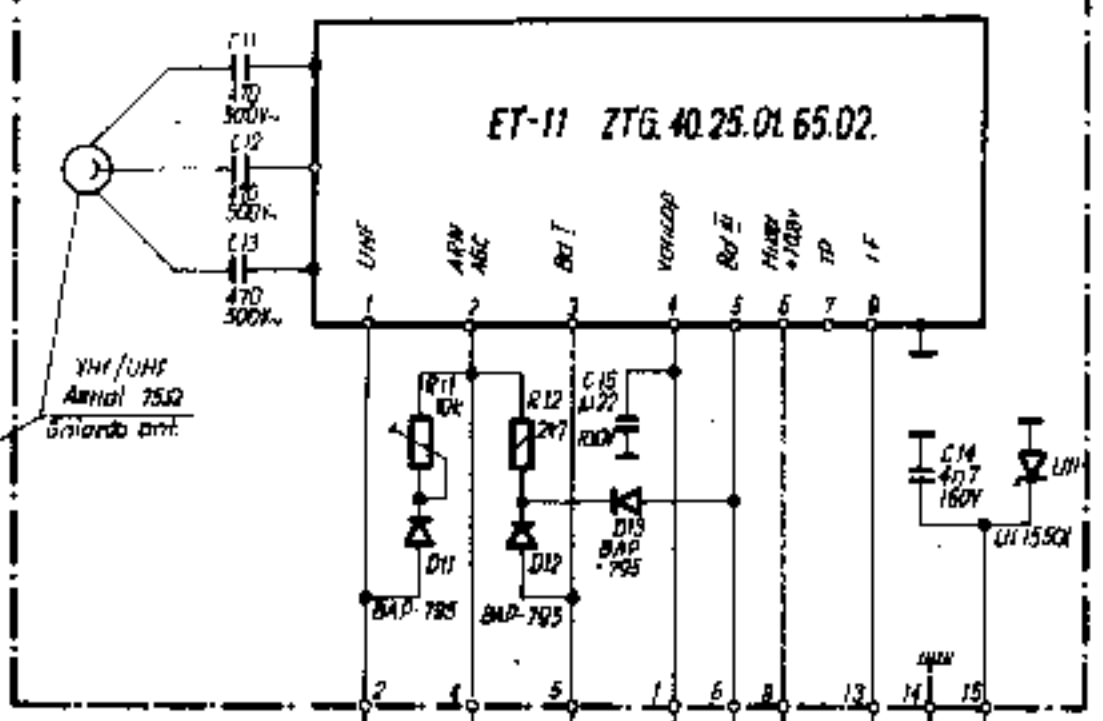

### MP 1003

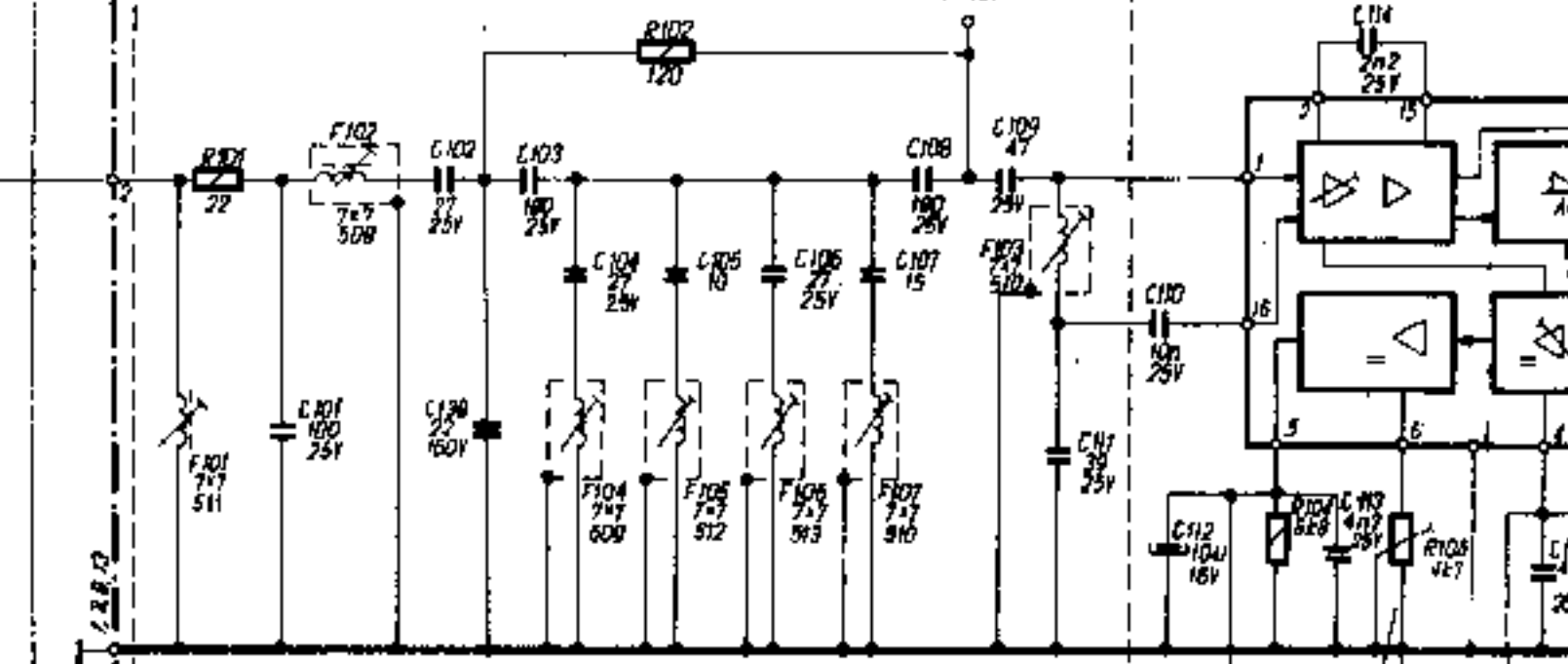

### Neptun 150

- Nmnoznik**  
Amplifier
- Nmnoznik DC**  
DC Amplifier
- Regulator fazy**  
Phase control
- Generator odchyln. pion.**  
H. Oscillator
- Przełącznik zakresu synchronizacji**  
Sync. Catching Range Switch
- Demodulator AM**  
AM Demodulator
- Nmnoznik z AGC**  
AGC Controlled Amplifier
- Kompensator fazy**  
Phase Detector
- Przełącznik Schmitta**  
Schmitt Multivibrator
- Separytor impulsów synchronizacji**  
Sync separator AGC gate/pulse trigger
- Stopień dźwiękowy**  
Sound stage
- Circuit synchronizacji**  
Sync circuit
- Generator przebiegu piłkarskiego**  
Ramp generator
- Generator porażenia**  
Frame generator
- Nmnoznik komplementarny mocy**  
Complementary power amp.

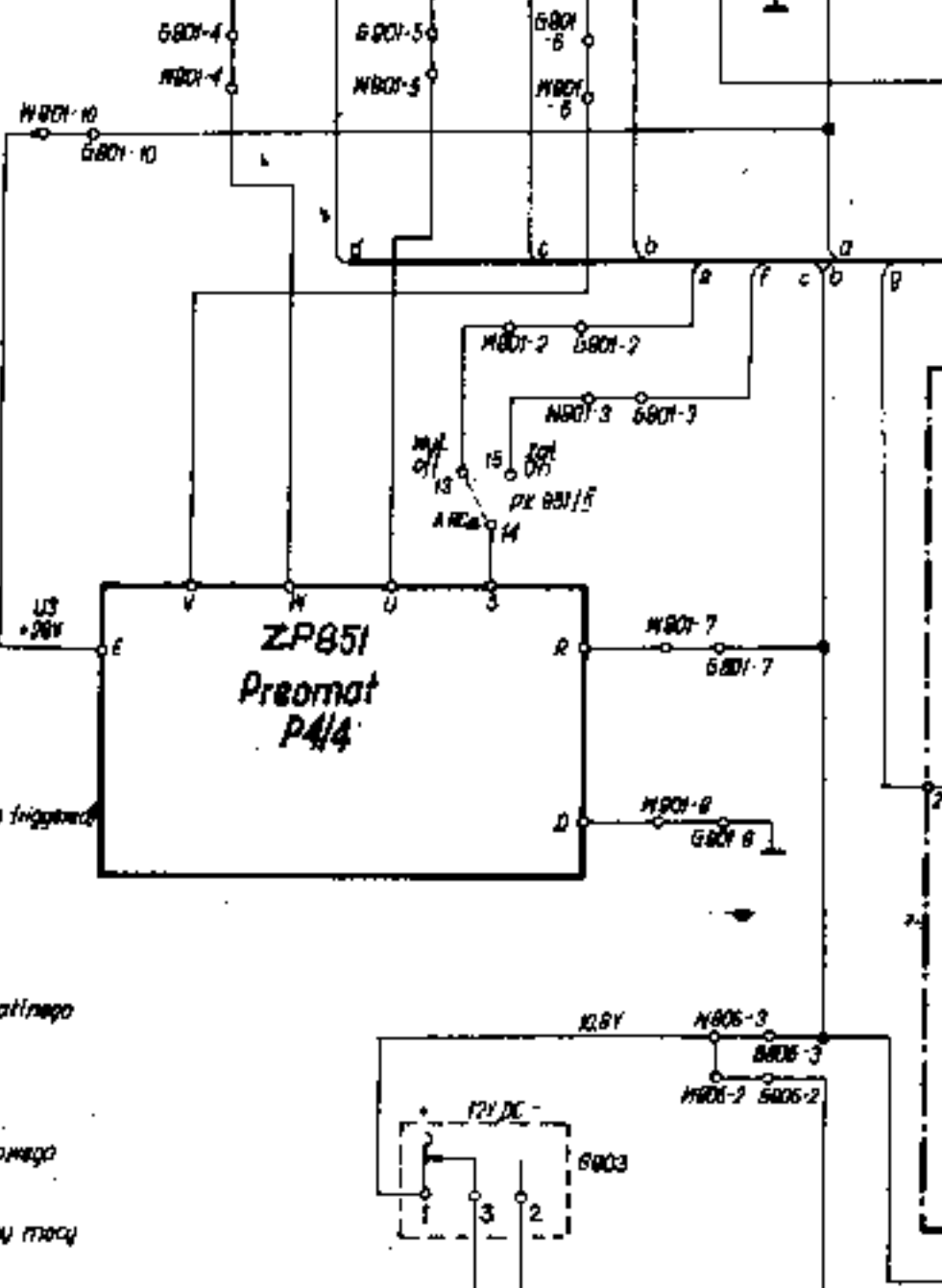

<http://www.schematy-tv.prv.pl>

### MS 1002

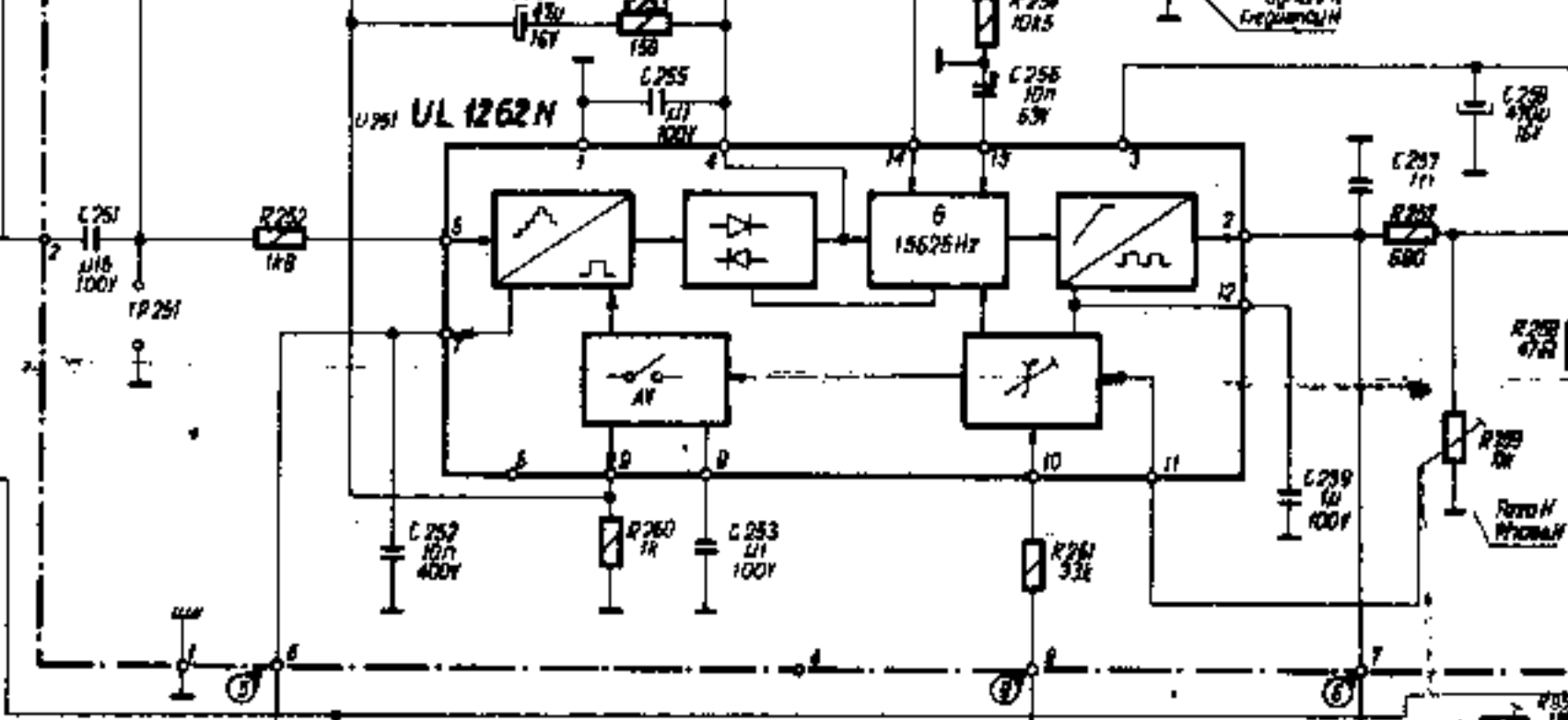

### BZ 1001

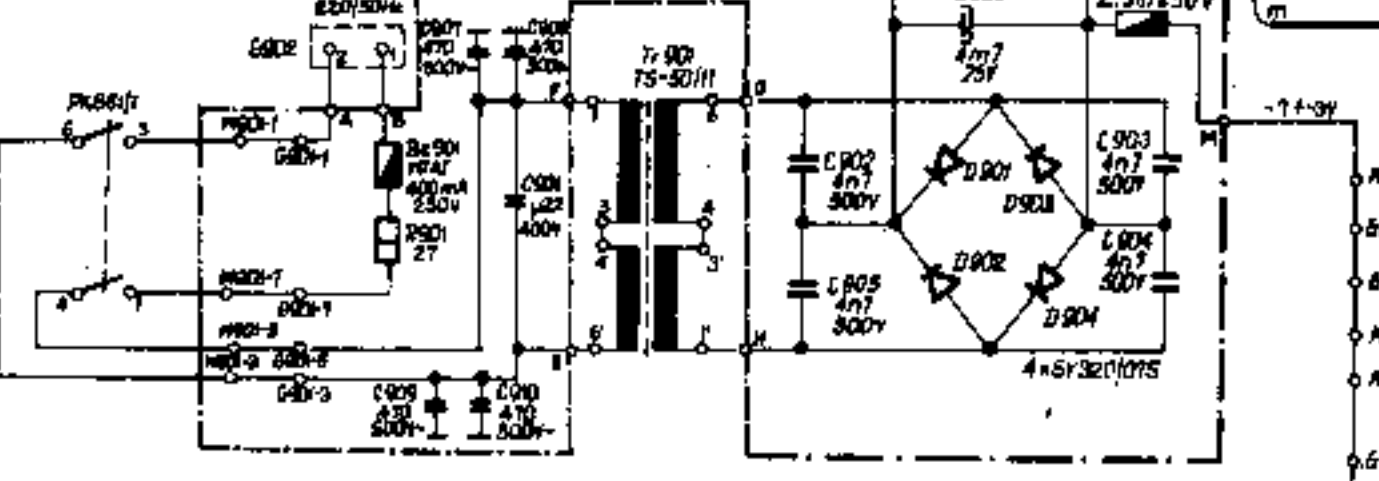

### MH 1001

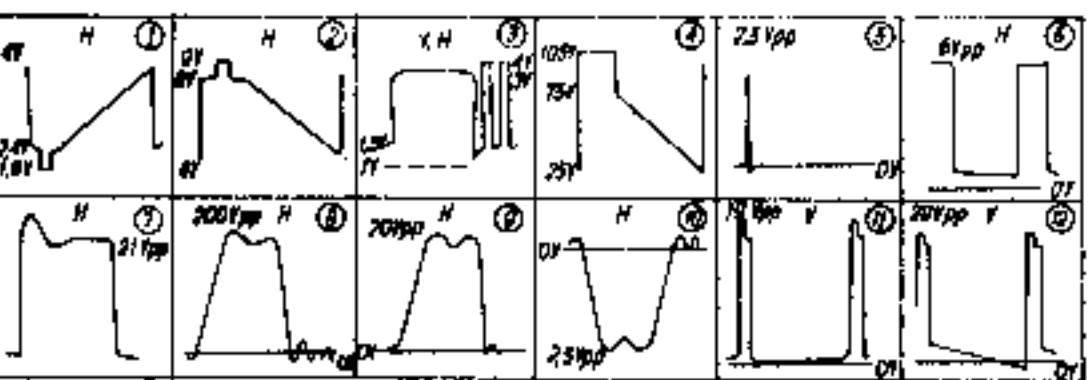
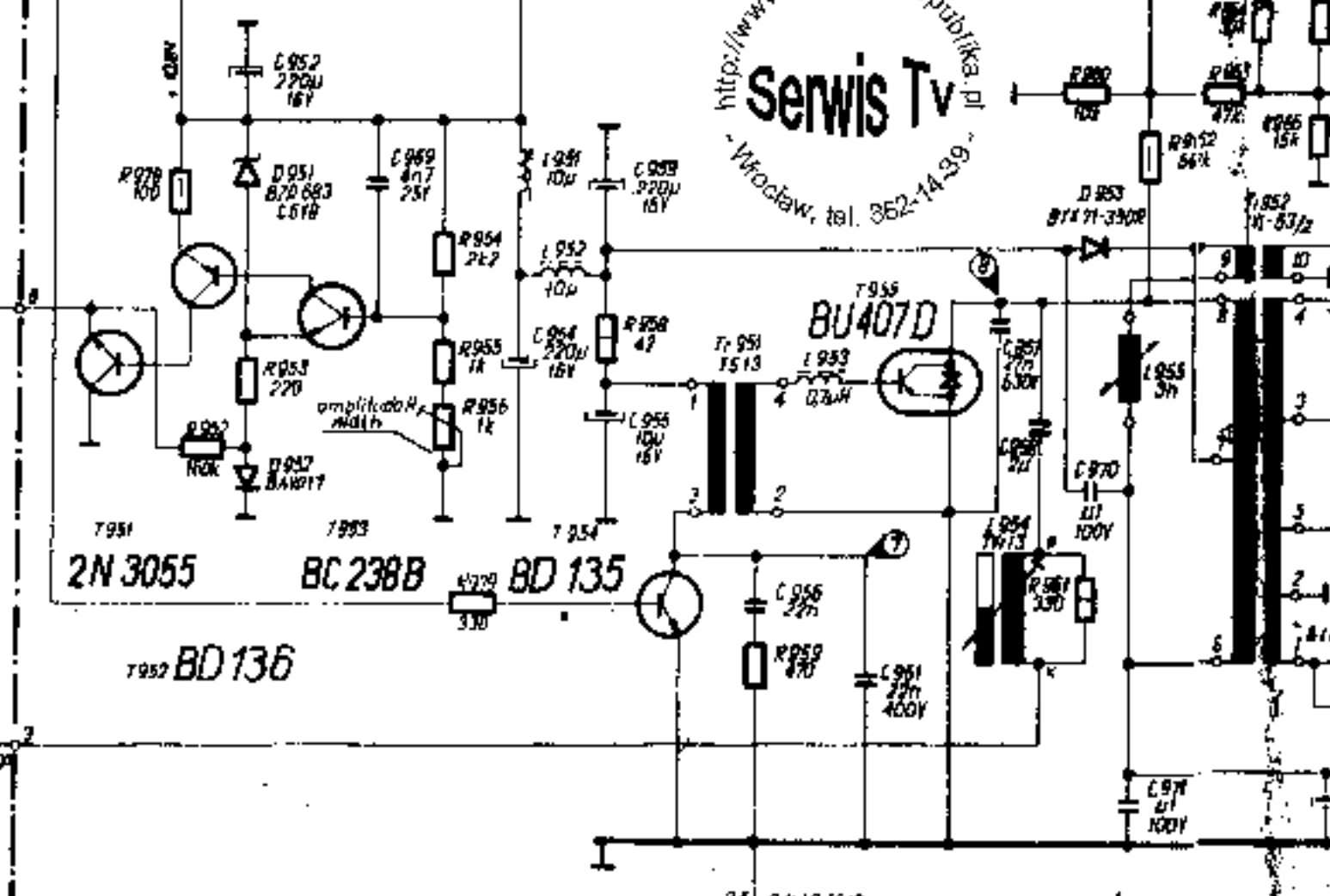

- Oznaczenie rezystorów**  
Resistor Power Code
- |  |        |  |          |
|--|--------|--|----------|
|  | 0.125W |  | BU 407D  |
|  | 0.25W  |  | BF 457   |
|  | 0.5W   |  | BD 135   |
|  | 1W     |  | BU 147A  |
|  | 2W     |  | UL 1755R |
- Widok z góry**  
Top View
- Widok od strony rdziel**  
Bottom View

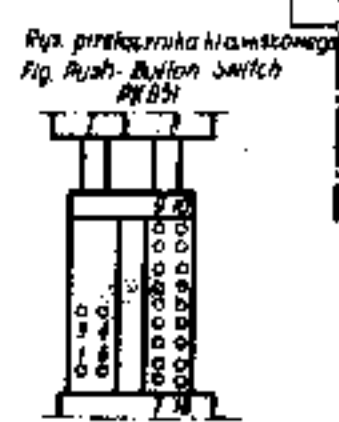

**Lista zamienników**  
Equivalent list

U11	UL 1550L	7K1-37	TDA 440	U101	TDA 440	U201	UL 1264N
U12	TAA 550	A-240 D	U1204N	U102	UL 1264N	U202	UL 1262N
U13	7K1-37	TAA 550	TAA 1204U	U103	UL 1264N	U203	TAA 1204U
U14	7K1-37	TAA 550	TAA 1204U	U104	UL 1264N	U204	TAA 1204U
U15	7K1-37	TAA 550	TAA 1204U	U105	UL 1264N	U205	TAA 1204U
U16	7K1-37	TAA 550	TAA 1204U	U106	UL 1264N	U206	TAA 1204U
U17	7K1-37	TAA 550	TAA 1204U	U107	UL 1264N	U207	TAA 1204U
U18	7K1-37	TAA 550	TAA 1204U	U108	UL 1264N	U208	TAA 1204U
U19	7K1-37	TAA 550	TAA 1204U	U109	UL 1264N	U209	TAA 1204U
U20	7K1-37	TAA 550	TAA 1204U	U110	UL 1264N	U210	TAA 1204U
U21	7K1-37	TAA 550	TAA 1204U	U111	UL 1264N	U211	TAA 1204U
U22	7K1-37	TAA 550	TAA 1204U	U112	UL 1264N	U212	TAA 1204U
U23	7K1-37	TAA 550	TAA 1204U	U113	UL 1264N	U213	TAA 1204U
U24	7K1-37	TAA 550	TAA 1204U	U114	UL 1264N	U214	TAA 1204U
U25	7K1-37	TAA 550	TAA 1204U	U115	UL 1264N	U215	TAA 1204U
U26	7K1-37	TAA 550	TAA 1204U	U116	UL 1264N	U216	TAA 1204U
U27	7K1-37	TAA 550	TAA 1204U	U117	UL 1264N	U217	TAA 1204U
U28	7K1-37	TAA 550	TAA 1204U	U118	UL 1264N	U218	TAA 1204U
U29	7K1-37	TAA 550	TAA 1204U	U119	UL 1264N	U219	TAA 1204U
U30	7K1-37	TAA 550	TAA 1204U	U120	UL 1264N	U220	TAA 1204U

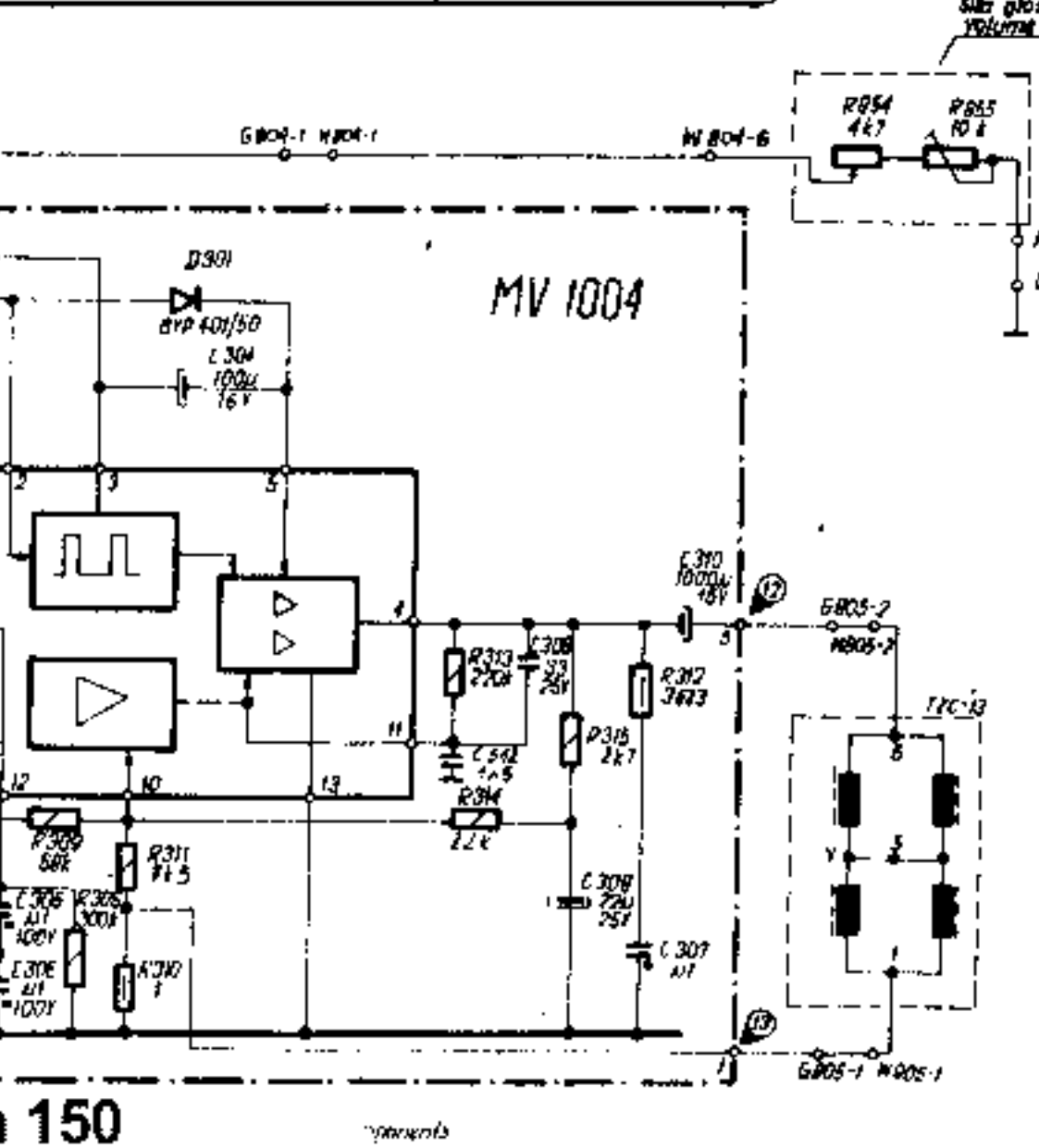
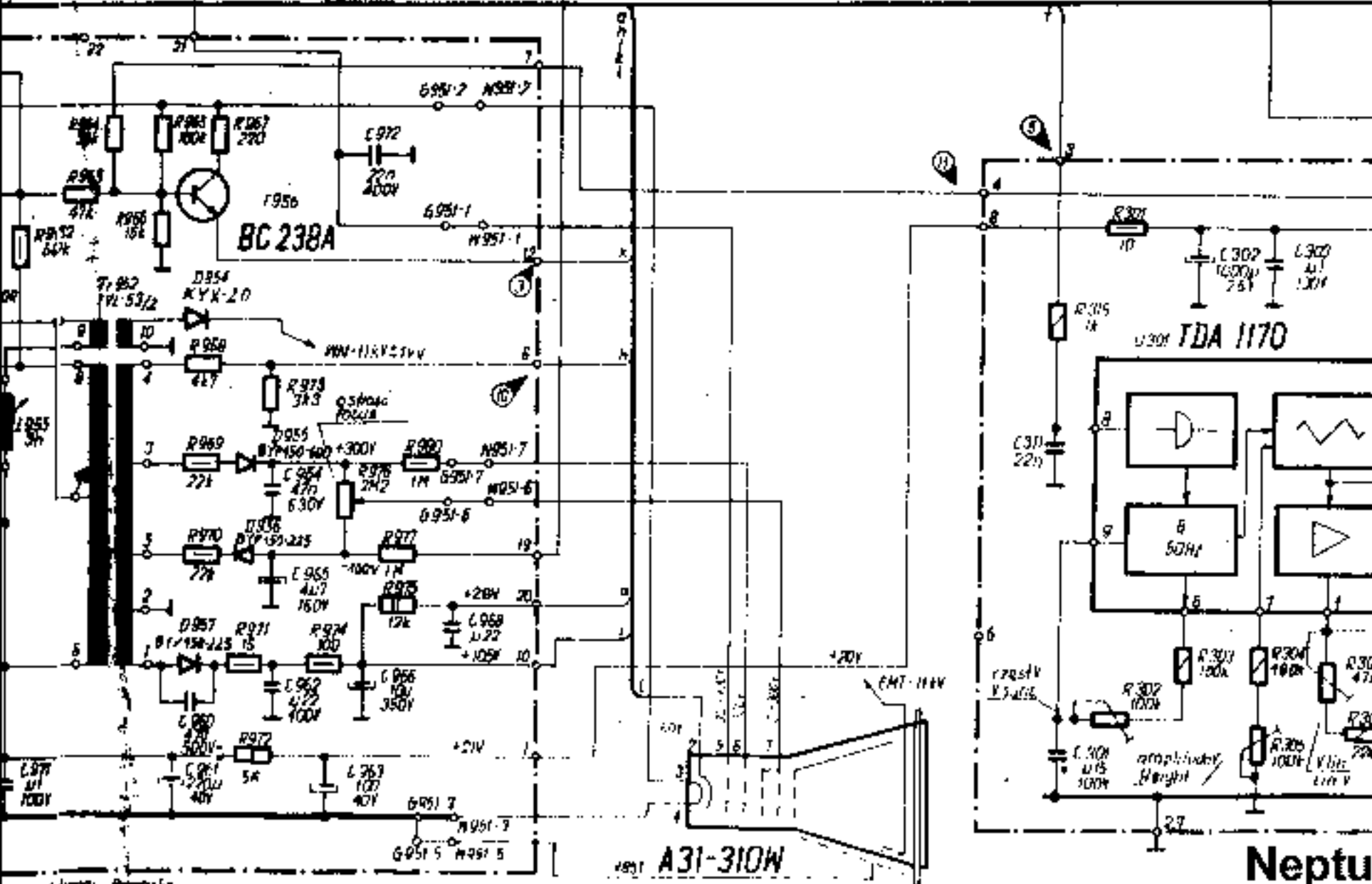
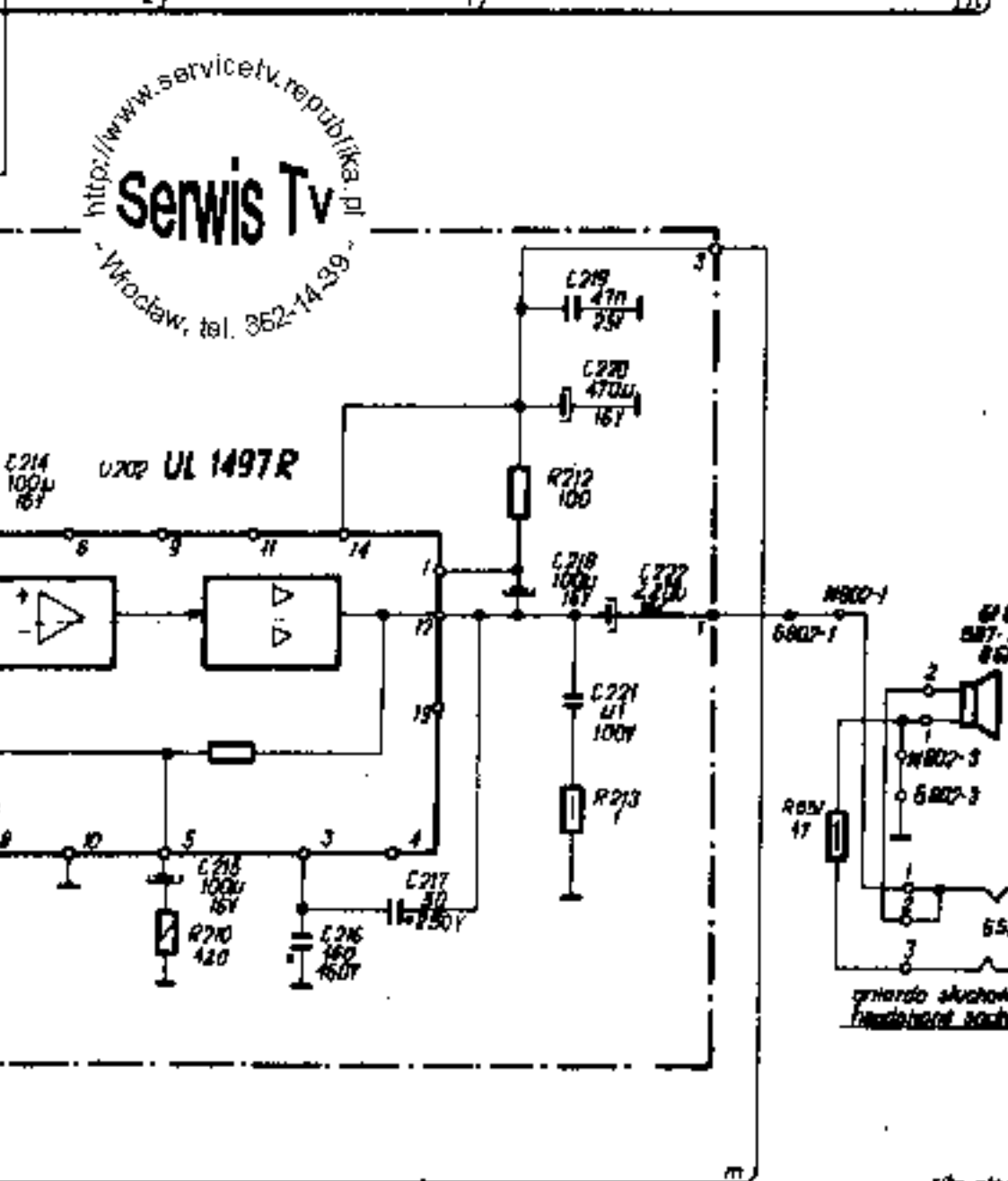
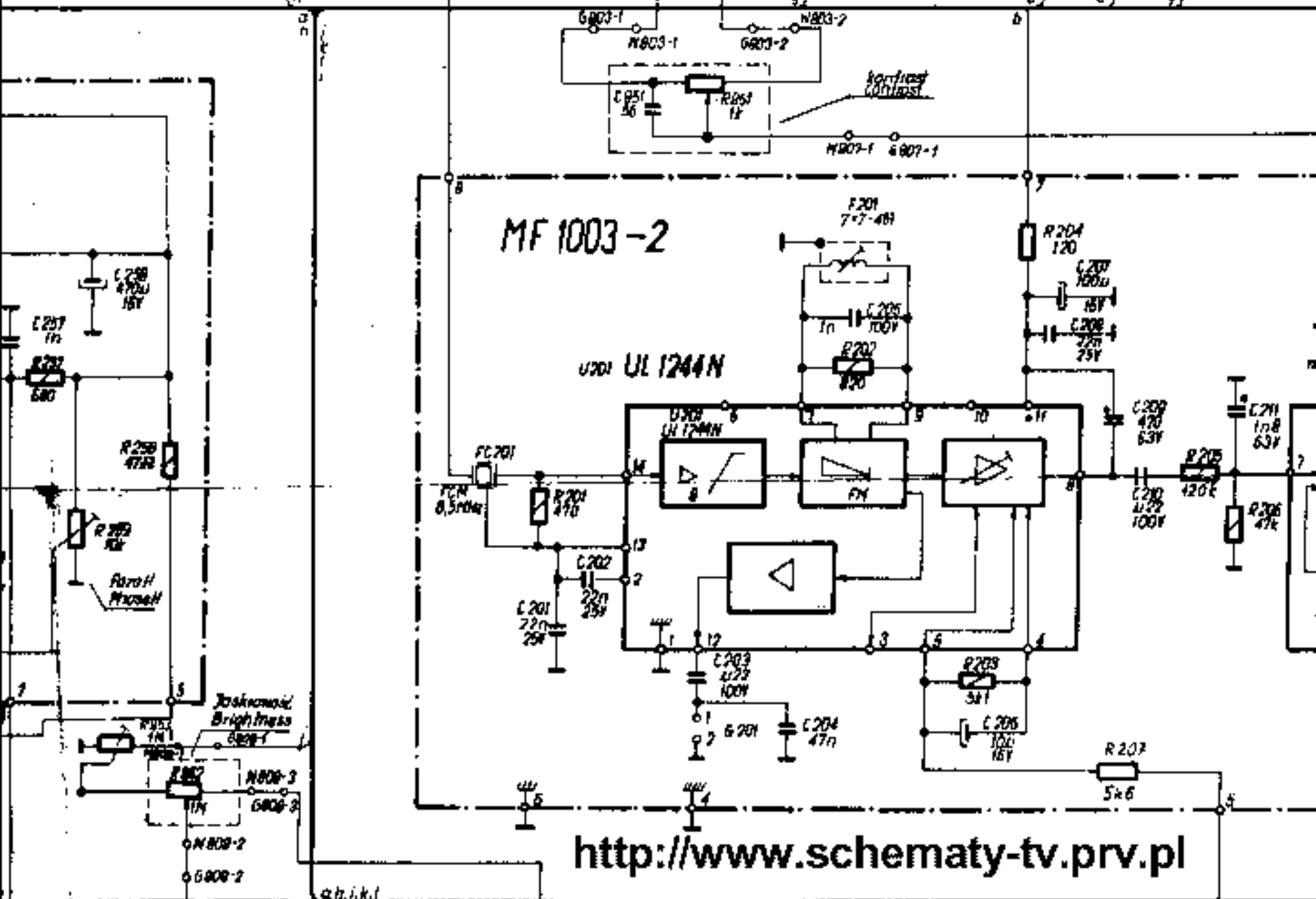
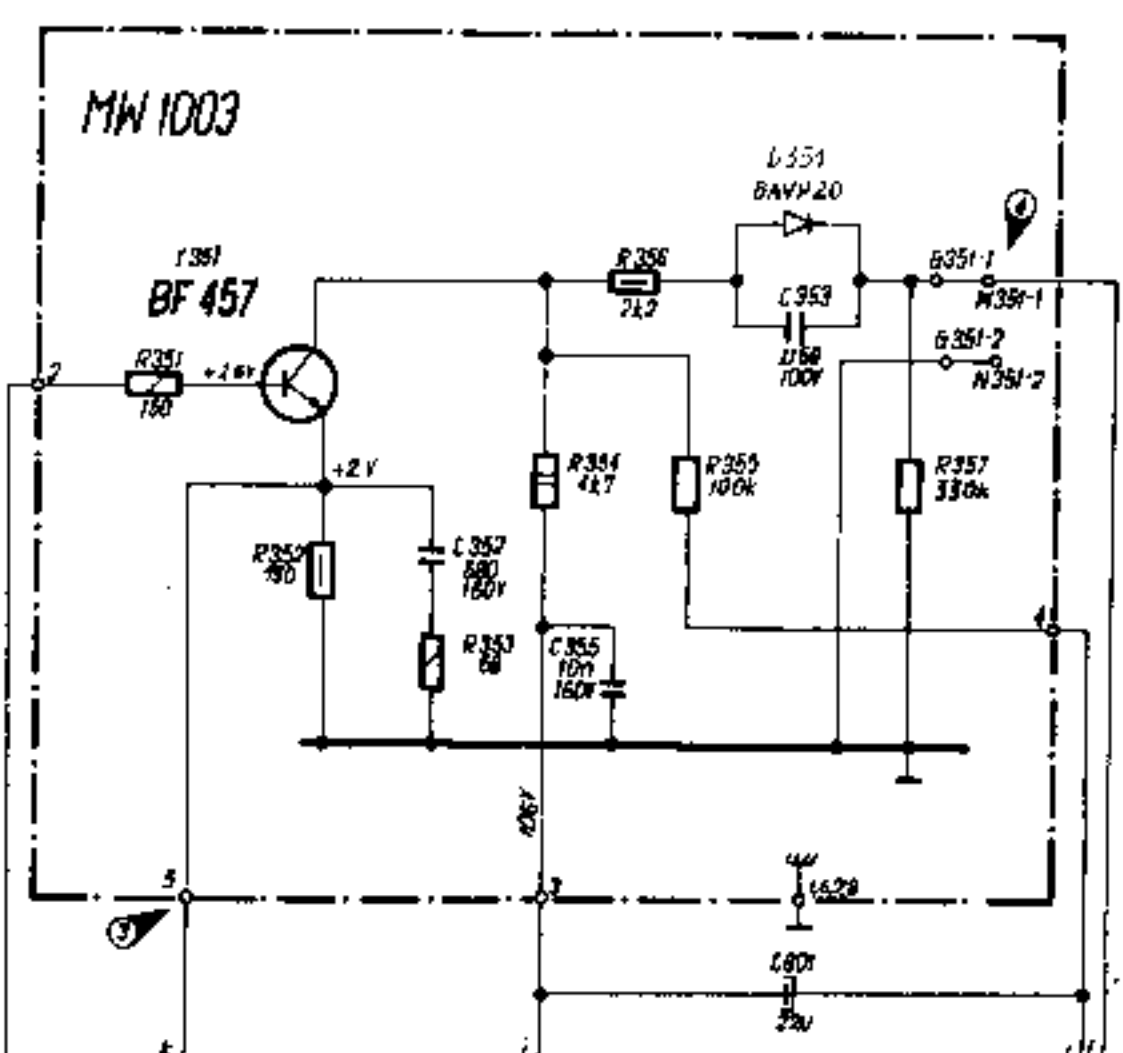
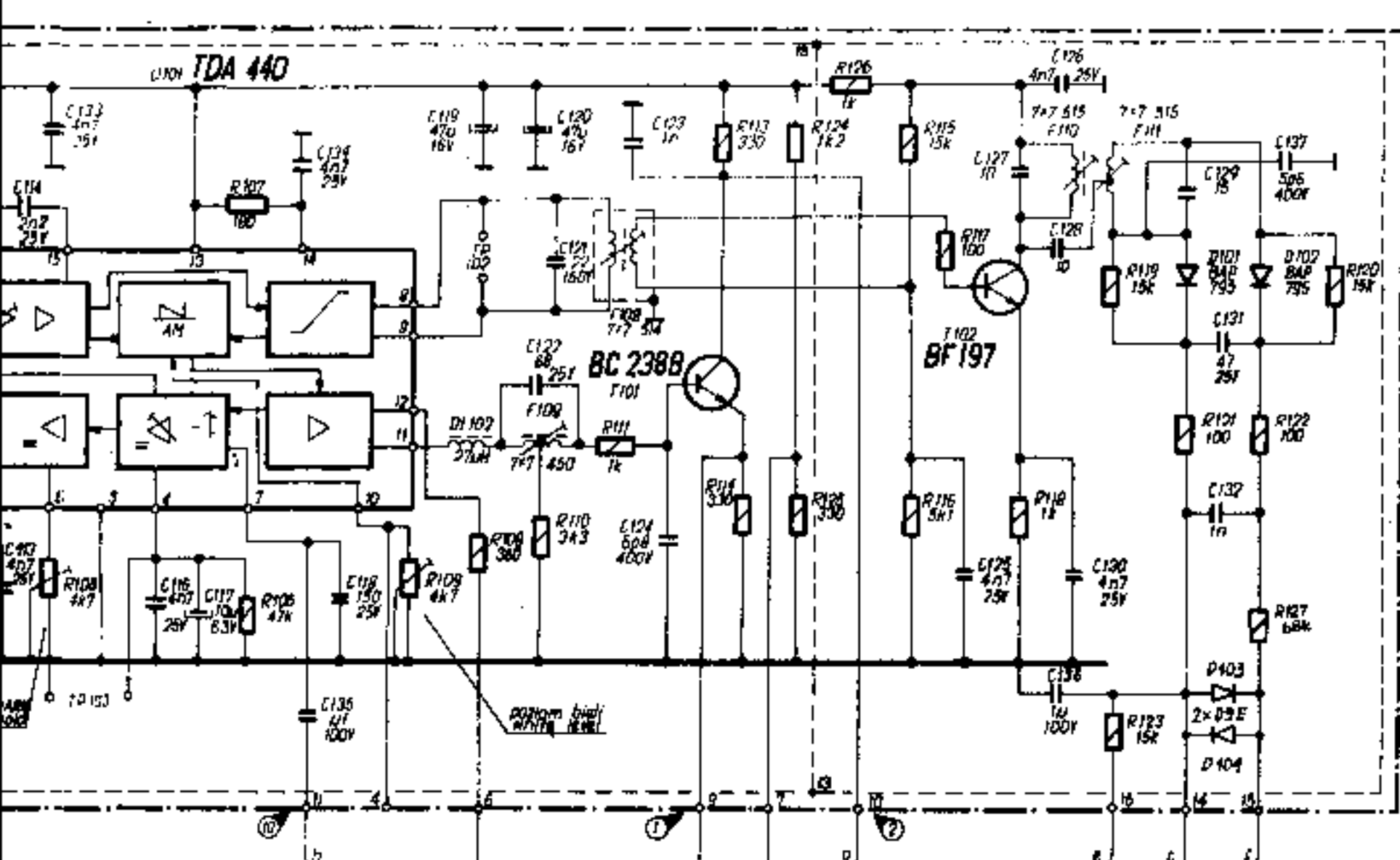

http://www.servisctv.republika.pl  
**Serwis Tv**  
 - Wroclaw, tel. 362-14-39 -

http://www.schematy-tv.prv.pl