

Intel[®] Core[™] i7-800 and i5-700 Desktop Processor Series

Datasheet – Volume 1

This is volume 1 of 2

July 2010



INFORMATION IN THIS DOCUMENT IS PROVIDED IN CONNECTION WITH INTEL® PRODUCTS. NO LICENSE, EXPRESS OR IMPLIED, BY ESTOPPEL OR OTHERWISE, TO ANY INTELLECTUAL PROPERTY RIGHTS IS GRANTED BY THIS DOCUMENT. EXCEPT AS PROVIDED IN INTEL'S TERMS AND CONDITIONS OF SALE FOR SUCH PRODUCTS, INTEL ASSUMES NO LIABILITY WHATSOEVER, AND INTEL DISCLAIMS ANY EXPRESS OR IMPLIED WARRANTY, RELATING TO SALE AND/OR USE OF INTEL PRODUCTS INCLUDING LIABILITY OR WARRANTIES RELATING TO FITNESS FOR A PARTICULAR PURPOSE, MERCHANTABILITY, OR INFRINGEMENT OF ANY PATENT, COPYRIGHT OR OTHER INTELLECTUAL PROPERTY RIGHT.

UNLESS OTHERWISE AGREED IN WRITING BY INTEL, THE INTEL PRODUCTS ARE NOT DESIGNED NOR INTENDED FOR ANY APPLICATION IN WHICH THE FAILURE OF THE INTEL PRODUCT COULD CREATE A SITUATION WHERE PERSONAL INJURY OR DEATH MAY OCCUR.

Intel may make changes to specifications and product descriptions at any time, without notice.

Designers must not rely on the absence or characteristics of any features or instructions marked "reserved" or "undefined." Intel reserves these for future definition and shall have no responsibility whatsoever for conflicts or incompatibilities arising from future changes to them.

The products described in this document may contain design defects or errors known as errata which may cause the product to deviate from published specifications. Current characterized errata are available on request.

Contact your local Intel sales office or your distributor to obtain the latest specifications and before placing your product order.

^AIntel processor numbers are not a measure of performance. Processor numbers differentiate features within each processor family, not across different processor families. See http://www.intel.com/products/processor_number for details. Over time processor numbers will increment based on changes in clock, speed, cache, FSB, or other features, and increments are not intended to represent proportional or quantitative increases in any particular feature. Current roadmap processor number progression is not necessarily representative of future roadmaps. See www.intel.com/products/processor_number for details.

Intel® Active Management Technology requires the computer system to have an Intel(R) AMT-enabled chipset, network hardware and software, as well as connection with a power source and a corporate network connection. Setup requires configuration by the purchaser and may require scripting with the management console or further integration into existing security frameworks to enable certain functionality. It may also require modifications of implementation of new business processes. With regard to notebooks, Intel AMT may not be available or certain capabilities may be limited over a host OS-based VPN or when connecting wirelessly, on battery power, sleeping, hibernating or powered off. For more information, see www.intel.com/technology/platform-technology/intel-amt/

Intel® Trusted Execution Technology (Intel® TXT) requires a computer system with Intel® Virtualization Technology (Intel® Virtualization Technology (Intel® VT-x) and Intel® Virtualization Technology for Directed I/O (Intel® VT-d)), a Intel TXT-enabled processor, chipset, BIOS, Authenticated Code Modules and an Intel TXT-compatible measured launched environment (MLE). The MLE could consist of a virtual machine monitor, an OS or an application. In addition, Intel TXT requires the system to contain a TPM v1.2, as defined by the Trusted Computing Group and specific software for some uses. For more information, see <http://www.intel.com/technology/security>

Intel® Virtualization Technology requires a computer system with an enabled Intel® processor, BIOS, virtual machine monitor (VMM) and, for some uses, certain computer system software enabled for it. Functionality, performance or other benefits will vary depending on hardware and software configurations and may require a BIOS update. Software applications may not be compatible with all operating systems. Please check with your application vendor.

Warning: Altering clock frequency and/or voltage may (i) reduce system stability and useful life of the system and processor; (ii) cause the processor and other system components to fail; (iii) cause reductions in system performance; (iv) cause additional heat or other damage; and (v) affect system data integrity. Intel has not tested, and does not warranty, the operation of the processor beyond its specifications.

* Intel® Turbo Boost Technology requires a PC with a processor with Intel Turbo Boost Technology capability. Intel Turbo Boost Technology performance varies depending on hardware, software and overall system configuration. Check with your PC manufacturer on whether your system delivers Intel Turbo Boost Technology. For more information, see <http://www.intel.com/technology/turboboost>

Hyper-threading Technology requires a computer system with a processor supporting HT Technology and an HT Technology-enabled chipset, BIOS, and operating system. Performance will vary depending on the specific hardware and software you use. For more information including details on which processors support HT Technology, see <http://www.intel.com/info/hypertexting>.

64-bit computing on Intel architecture requires a computer system with a processor, chipset, BIOS, operating system, device drivers and applications enabled for Intel® 64 architecture. Performance will vary depending on your hardware and software configurations. Consult with your system vendor for more information.

Enabling Execute Disable Bit functionality requires a PC with a processor with Execute Disable Bit capability and a supporting operating system. Check with your PC manufacturer on whether your system delivers Execute Disable Bit functionality.

Enhanced Intel SpeedStep® Technology for specified units of this processor available Q2/06. See the Processor Spec Finder at <http://processorfinder.intel.com> or contact your Intel representative for more information.

Intel, Intel Core, Core Inside, Intel Speedstep, and the Intel logo are trademarks of Intel Corporation in the U.S. and other countries.

*Other names and brands may be claimed as the property of others.

Copyright © 2009-2010, Intel Corporation. All rights reserved.



Contents

1	Introduction	9
1.1	Processor Feature Details	11
1.1.1	Supported Technologies	11
1.2	Interfaces	11
1.2.1	System Memory Support	11
1.2.2	PCI Express*	12
1.2.3	Direct Media Interface (DMI)	13
1.2.4	Platform Environment Control Interface (PECI)	13
1.3	Power Management Support	14
1.3.1	Processor Core	14
1.3.2	System	14
1.3.3	Memory Controller	14
1.3.4	PCI Express*	14
1.4	Thermal Management Support	14
1.5	Package	14
1.6	Terminology	15
1.7	Related Documents	17
2	Interfaces	19
2.1	System Memory Interface	19
2.1.1	System Memory Technology Supported	19
2.1.2	System Memory Timing Support	20
2.1.3	System Memory Organization Modes	20
2.1.3.1	Single-Channel Mode	20
2.1.3.2	Dual-Channel Mode—Intel® Flex Memory Technology Mode	21
2.1.4	Rules for Populating Memory Slots	22
2.1.5	Technology Enhancements of Intel® Fast Memory Access (Intel® FMA)	23
2.1.5.1	Just-in-Time Command Scheduling	23
2.1.5.2	Command Overlap	23
2.1.5.3	Out-of-Order Scheduling	23
2.1.6	System Memory Pre-Charge Power Down Support Details	23
2.2	PCI Express* Interface	24
2.2.1	PCI Express* Architecture	24
2.2.1.1	Transaction Layer	25
2.2.1.2	Data Link Layer	25
2.2.1.3	Physical Layer	25
2.2.2	PCI Express* Configuration Mechanism	26
2.2.3	PCI Express* Ports and Bifurcation	27
2.2.3.1	PCI Express* Bifurcated Mode	27
2.3	Direct Media Interface (DMI)	27
2.3.1	DMI Error Flow	27
2.3.2	Processor/PCH Compatibility Assumptions	27
2.3.3	DMI Link Down	27
2.4	Platform Environment Control Interface (PECI)	28
2.5	Interface Clocking	28
2.5.1	Internal Clocking Requirements	28
3	Technologies	29
3.1	Intel® Virtualization Technology	29
3.1.1	Intel® VT-x Objectives	29
3.1.2	Intel® VT-x Features	29



3.1.3	Intel® VT-d Objectives	30
3.1.4	Intel® VT-d Features	30
3.1.5	Intel® VT-d Features Not Supported	31
3.2	Intel® Trusted Execution Technology (Intel® TXT)	31
3.3	Intel® Hyper-Threading Technology	32
3.4	Intel® Turbo Boost Technology	32
4	Power Management	33
4.1	ACPI States Supported	33
4.1.1	System States	33
4.1.2	Processor Core/Package Idle States	33
4.1.3	Integrated Memory Controller States	33
4.1.4	PCI Express* Link States	34
4.1.5	Interface State Combinations	34
4.2	Processor Core Power Management	34
4.2.1	Enhanced Intel® SpeedStep® Technology	34
4.2.2	Low-Power Idle States	35
4.2.3	Requesting Low-Power Idle States	36
4.2.4	Core C-states	37
4.2.4.1	Core C0 State	37
4.2.4.2	Core C1/C1E State	37
4.2.4.3	Core C3 State	38
4.2.4.4	Core C6 State	38
4.2.4.5	C-State Auto-Demotion	38
4.2.5	Package C-States	38
4.2.5.1	Package C0	40
4.2.5.2	Package C1/C1E	40
4.2.5.3	Package C3 State	40
4.2.5.4	Package C6 State	40
4.3	Integrated Memory Controller (IMC) Power Management	41
4.3.1	Disabling Unused System Memory Outputs	41
4.3.2	DRAM Power Management and Initialization	41
4.3.2.1	Initialization Role of CKE	41
4.3.2.2	Conditional Self-Refresh	41
4.3.2.3	Dynamic Power Down Operation	42
4.3.2.4	DRAM I/O Power Management	42
4.4	PCI Express* Power Management	42
5	Thermal Management	43
6	Signal Description	45
6.1	System Memory Interface	46
6.2	Memory Reference and Compensation	48
6.3	Reset and Miscellaneous Signals	48
6.4	PCI Express* Based Interface Signals	49
6.5	DMI—Processor to PCH Serial Interface	49
6.6	PLL Signals	50
6.7	Intel® Flexible Display Interface Signals	50
6.8	JTAG/ITP Signals	51
6.9	Error and Thermal Protection	52
6.10	Power Sequencing	53
6.11	Processor Core Power Signals	53
6.12	Graphics and Memory Core Power Signals	55
6.13	Ground and NCTF	56
6.14	Processor Internal Pull Up/Pull Down	56



7	Electrical Specifications	57
7.1	Power and Ground Lands.....	57
7.2	Decoupling Guidelines	57
7.2.1	Voltage Rail Decoupling.....	57
7.3	Processor Clocking (BCLK[0], BCLK#[0])	58
7.3.1	PLL Power Supply	58
7.4	V _{CC} Voltage Identification (VID)	58
7.5	Reserved or Unused Signals.....	62
7.6	Signal Groups	62
7.7	Test Access Port (TAP) Connection.....	65
7.8	Absolute Maximum and Minimum Ratings	65
7.9	DC Specifications	66
7.9.1	Voltage and Current Specifications.....	66
7.10	Platform Environmental Control Interface (PECI) DC Specifications.....	73
7.10.1	DC Characteristics	73
7.10.2	Input Device Hysteresis	74
8	Processor Land and Signal Information	75
8.1	Processor Land Assignments	75



Figures

1-1 Intel® Core™ i7-800 and i5-700 Desktop Processor Series Platform Diagram.....	10
2-1 Intel® Flex Memory Technology Operation	21
2-2 Dual-Channel Symmetric (Interleaved) and Dual-Channel Asymmetric Modes.....	22
2-3 PCI Express* Layering Diagram.....	24
2-4 Packet Flow through the Layers.....	25
2-5 PCI Express* Related Register Structures in Processor.....	26
4-1 Idle Power Management Breakdown of the Processor Cores.....	35
4-2 Thread and Core C-State Entry and Exit	36
4-3 Package C-State Entry and Exit	39
7-1 V _{CC} Static and Transient Tolerance Loadlines.....	69
7-2 Input Device Hysteresis.....	74
8-1 Socket Pinmap (Top View, Upper-Left Quadrant)	76
8-2 Socket Pinmap (Top View, Upper-Right Quadrant)	77
8-3 Socket Pinmap (Top View, Lower-Left Quadrant)	78
8-4 Socket Pinmap (Top View, Lower-Right Quadrant)	79

Tables

1-1 Intel® Core™ i7-800 and i5-700 Desktop Processor Series SKU Supported Memory Summary.....	11
1-2 Related Documents	17
2-1 Supported DIMM Module Configurations	19
2-2 DDR3 System Memory Timing Support.....	20
2-3 System Memory Pre-Charge Power Down Support	23
2-4 Processor Reference Clock Requirements.....	28
4-1 Processor Core/Package State Support.....	33
4-2 G, S, and C State Combinations	34
4-3 Coordination of Thread Power States at the Core Level.....	36
4-4 P_LVLx to MWAIT Conversion.....	37
4-5 Coordination of Core Power States at the Package Level	39
4-6 Targeted Memory State Conditions	42
6-1 Signal Description Buffer Types	45
6-2 Memory Channel A	46
6-3 Memory Channel B	47
6-4 Memory Reference and Compensation.....	48
6-5 Reset and Miscellaneous Signals.....	48
6-6 PCI Express* Based Interface Signals	49
6-7 DMI—Processor to PCH Serial Interface	49
6-8 PLL Signals.....	50
6-9 Intel® Flexible Display Interface.....	50
6-10 JTAG/ITP.....	51
6-11 Error and Thermal Protection	52
6-12 Power Sequencing	53
6-13 Processor Core Power Signals	53
6-14 Graphics and Memory Power Signals	55
6-15 Ground and NCTF.....	56
6-16 Processor Internal Pull Up/Pull Down.....	56
7-1 VRD 11.1/11.0 Voltage Identification Definition	59
7-2 Market Segment Selection Truth Table for MSID[2:0].....	61
7-3 Signal Groups 1	63
7-4 Processor Absolute Minimum and Maximum Ratings.....	65
7-5 Processor Core Active and Idle Mode DC Voltage and Current Specifications	66
7-6 Processor Uncore I/O Buffer Supply DC Voltage and Current Specifications	67
7-7 V _{CC} Static and Transient Tolerance	68
7-8 DDR3 Signal Group DC Specifications.....	70



7-9	Control Sideband and TAP Signal Group DC Specifications	71
7-10	PCI Express* DC Specifications.....	72
7-11	PECI DC Electrical Limits	73
8-1	Signals Not Used by the Intel® Core™ i7-800 and i5-700 Desktop Processor Series	75
8-2	Processor Pin List by Pin Name	80

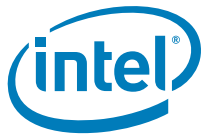

Revision History

Revision Number	Description	Date
001	<ul style="list-style-type: none">Initial release	September 2009
002	<ul style="list-style-type: none">Added Intel® Core™ i7-860S and i5-750S processors	January 2010
003	<ul style="list-style-type: none">Added Intel® Core™ i7-875K and i7-880 processors	June 2010
004	<ul style="list-style-type: none">Added Intel® Core™ i5-760 and i7-870S processors	July 2010

§ §



1 Introduction

The Intel® Core™ i7-800 and i5-700 desktop processor series are the next generation of 64-bit, multi-core processors built on 45-nanometer process technology. Based on the low-power/high-performance Intel microarchitecture, the processor is designed for a two-chip platform, instead of the traditional three-chip platforms (processor, (G)MCH, and ICH). The two-chip platform consists of a processor and Platform Controller Hub (PCH) and enables higher performance, easier validation, and improved x-y footprint. The Intel® 5 Series Chipset components for desktop are the PCH. The Intel® Core™ i7-800 and i5-700 desktop processor series are designed for desktop platforms.

This document provides DC electrical specifications, signal integrity, differential signaling specifications, pinout and signal definitions, interface functional descriptions, and additional feature information pertinent to the implementation and operation of the processor on its respective platform.

Note: Throughout this document, the Intel® Core™ i7-800 and i5-700 desktop processor series may be referred to as “processor”.

Note: Throughout this document, the Intel® Core™ i7-800 desktop processor series refers to the Intel® Core™ i7-880, i7-875K, i7-870, i7-870S, i7-860, and i7-860S processors.

Note: Throughout this document, the Intel® Core™ i5-700 desktop processor series refers to the Intel® Core™ i5-760, i5-750, and i5-750S processor.

Note: Throughout this document, the Intel® 5 series Chipset Platform Controller Hub may also be referred to as “PCH”.

Note: Some processor features are not available on all platforms. Refer to the processor specification update for details.

Included in this family of processors is an integrated memory controller (IMC) and integrated I/O (IIO) (such as PCI Express* and DMI) on a single silicon die. This single die solution is known as a monolithic processor. For specific features supported for individual Intel Core™ i7-800 and i5-700 desktop processor series SKUs, refer to the *Intel® Core™ i7-800 and i5-700 Desktop Processor Series Specification Update*.

[Figure 1-1](#) shows an example desktop platform block diagram.

Figure 1-1. Intel® Core™ i7-800 and i5-700 Desktop Processor Series Platform Diagram

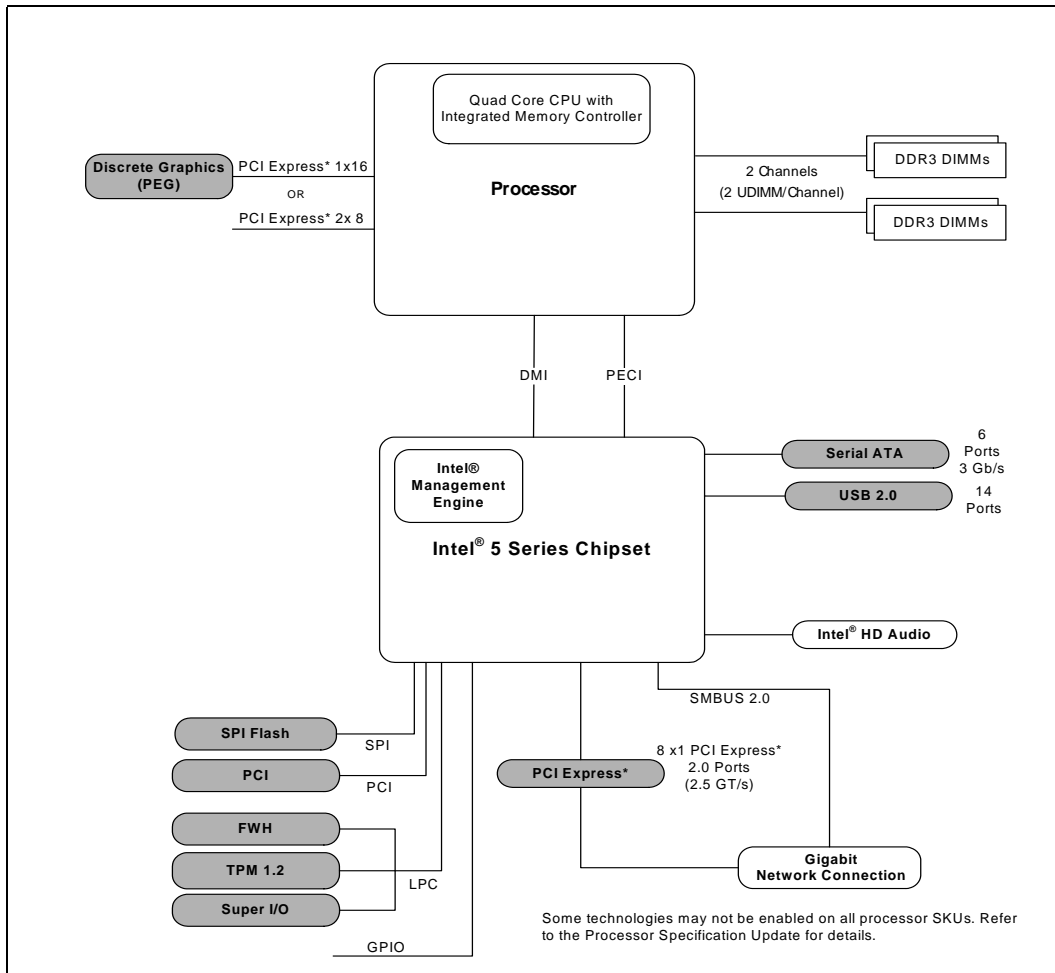



1.1 Processor Feature Details

- Four cores
- A 32-KB instruction and 32-KB data first-level cache (L1) for each core
- A 256-KB shared instruction/data second-level cache (L2) for each core
- 8-MB shared instruction/data last-level cache (L3), shared among all cores

1.1.1 Supported Technologies

- Intel® Virtualization Technology for Directed I/O (Intel® VT-d)
- Intel® Virtualization Technology (Intel® VT-x)
- Intel® Trusted Execution Technology (Intel® TXT)
- Intel® Streaming SIMD Extensions 4.1 (Intel® SSE4.1)
- Intel® Streaming SIMD Extensions 4.2 (Intel® SSE4.2)
- Intel® Hyper-Threading Technology
- Intel® 64 Architecture
- Execute Disable Bit
- Intel® Turbo Boost Technology

Note: Some technologies may not be enabled on all processor SKUs. Refer to the processor specification update for details.

1.2 Interfaces

1.2.1 System Memory Support

Table 1-1. Intel® Core™ i7-800 and i5-700 Desktop Processor Series SKU Supported Memory Summary

Platform	Memory Type	# of Channels	DIMMs/Channel	Transfer Rate (MT/s)	Notes
Desktop Intel 5 Series Chipset Platform	DDR3: Non-ECC Unbuffered	1 or 2	1 or 2	1066, 1333	1

Notes:

1. ECC DIMMs and mixing of non-ECC and ECC DIMMs are not supported.

System memory features include:

- Data burst length of eight for all memory organization modes
- 64-bit wide channels
- DDR3 I/O Voltage of 1.5 V
- Maximum memory bandwidth of 10.6 GB/s in single-channel mode or 21 GB/s in dual-channel mode assuming DDR3 1333 MT/s
- 1-Gb and 2-Gb DDR3 DRAM technologies are supported.
- Using 2-Gb device technologies, the largest memory capacity possible is 16 GB for UDIMMs (assuming Dual Channel Mode with a four dual rank unbuffered DIMM memory configuration)



- Up to 64 simultaneous open pages, 32 per channel (assuming 8 ranks of 8 bank devices)
- Command launch modes of 1n/2n
- Intel® Fast Memory Access (Intel® FMA)
 - Just-in-Time Command Scheduling
 - Command Overlap
 - Out-of-Order Scheduling

1.2.2 PCI Express*

- The processor PCI Express* port(s) are fully-compliant with the *PCI Express Base Specification, Revision 2.0*.
- Intel® Core™ i7-800 and i5-700 desktop processor series with Intel 5 Series Chipset SKUs support:
 - One 16-lane PCI Express port configurable to two 8-lane PCI Express ports intended for Graphics Attach.
- PCI Express port 0 is mapped to PCI Device 3.
- PCI Express port 1 is mapped to PCI Device 5.
- The port may negotiate down to narrower widths.
 - Support for x16/x8/x4/x1 widths for a single PCI Express mode.
- 2.5 GT/s and 5.0 GT/s PCI Express frequencies are supported.
- Either port can be configured independently as 2.5 GT/s or 5.0 GT/s.
- Raw bit-rate on the data pins of 5.0 GB/s, resulting in a real bandwidth per pair of 500 MB/s given the 8b/10b encoding used to transmit data across this interface. This also does not account for packet overhead and link maintenance.
- Maximum theoretical bandwidth on interface of 8 GB/s in each direction simultaneously, for an aggregate of 16 GB/s for x16.
- Hierarchical PCI-compliant configuration mechanism for downstream devices.
- Traditional PCI style traffic (asynchronous snooped, PCI ordering).
- PCI Express extended configuration space. The first 256 bytes of configuration space aliases directly to the PCI Compatibility configuration space. The remaining portion of the fixed 4-KB block of memory-mapped space above that (starting at 100h) is known as extended configuration space.
- PCI Express Enhanced Access Mechanism. Accessing the device configuration space in a flat memory mapped fashion.
- Automatic discovery, negotiation, and training of link out of reset.
- Traditional AGP style traffic (asynchronous non-snooped, PCI-X* Relaxed ordering).
- Peer segment destination posted write traffic (no peer-to-peer read traffic) in Virtual Channel 0:
 - PCI Express Port 0 -> PCI Express Port 1
 - PCI Express Port 1 -> PCI Express Port 0
 - DMI -> PCI Express Port 0
 - DMI -> PCI Express Port 1
 - PCI Express Port 1 -> DMI
 - PCI Express Port 0 -> DMI
- 64-bit downstream address format, but the processor never generates an address above 64 GB (Bits 63:36 will always be zeros).
- 64-bit upstream address format, but the processor responds to upstream read transactions to addresses above 64 GB (addresses where any of Bits 63:36 are



nonzero) with an Unsupported Request response. Upstream write transactions to addresses above 64 GB will be dropped.

- Re-issues Configuration cycles that have been previously completed with the Configuration Retry status.
- PCI Express reference clock is 100-MHz differential clock.
- Power Management Event (PME) functions.
- Dynamic lane numbering reversal as defined by the PCI Express Base Specification.
- Dynamic frequency change capability (2.5 GT/s - 5.0 GT/s)
- Dynamic width capability
- Message Signaled Interrupt (MSI and MSI-X) messages
- Polarity inversion

1.2.3 Direct Media Interface (DMI)

- Four lanes in each direction.
- 2.5 GT/s point-to-point DMI interface to PCH is supported.
- Raw bit-rate on the data pins of 2.5 GB/s, resulting in a real bandwidth per pair of 250 MB/s given the 8b/10b encoding used to transmit data across this interface. Does not account for packet overhead and link maintenance.
- Maximum theoretical bandwidth on interface of 1 GB/s in each direction simultaneously, for an aggregate of 2 GB/s when DMI x4.
- Shares 100-MHz PCI Express reference clock.
- 64-bit downstream address format, but the processor never generates an address above 64 GB (Bits 63:36 will always be zeros).
- 64-bit upstream address format, but the processor responds to upstream read transactions to addresses above 64 GB (addresses where any of Bits 63:36 are nonzero) with an Unsupported Request response. Upstream write transactions to addresses above 64 GB will be dropped.
- Supports the following traffic types to or from the PCH
 - DMI -> PCI Express Port 0 write traffic
 - DMI -> PCI Express Port 1 write traffic
 - DMI -> DRAM
 - DMI -> processor core (Virtual Legacy Wires (VLWs), Resetwarn, or MSIs only)
 - Processor core -> DMI
- APIC and MSI interrupt messaging support
 - Message Signaled Interrupt (MSI and MSI-X) messages
- Downstream SMI, SCI, and SERR error indication
- Legacy support for ISA regime protocol (PHOLD/PHOLDA) required for parallel port DMA, floppy drive, and LPC bus masters
- DC coupling – no capacitors between the processor and the PCH
- Polarity inversion
- PCH end-to-end lane reversal across the link
- Supports Half Swing “low-power/low-voltage” and Full Swing “high-power/high-voltage” modes

1.2.4 Platform Environment Control Interface (PECI)

The Peci is a one-wire interface that provides a communication channel between processor and a Peci master, usually the PCH.



1.3 Power Management Support

1.3.1 Processor Core

- Full support of ACPI C-states as implemented by the following processor C-states:
 - C0, C1, C1E, C3, C6
- Enhanced Intel SpeedStep[®] Technology

1.3.2 System

- S0, S1, S3, S4, S5

1.3.3 Memory Controller

- Conditional self-refresh
- Dynamic power-down

1.3.4 PCI Express*

- L0s and L1 ASPM power management capability.

1.4 Thermal Management Support

- Digital Thermal Sensor
- Intel[®] Adaptive Thermal Monitor
- THERMTRIP# and PROCHOT# support
- On-Demand Mode
- Memory Thermal Throttling
- External Thermal Sensor
- Fan Speed Control with DTS

1.5 Package

- The processor socket type is noted as LGA 1156. The package is a 37.5 x 37.5 mm Flip Chip Land Grid Array (FCLGA 1156).



1.6 Terminology

Term	Description
DDR3	Third generation Double Data Rate SDRAM memory technology
DP	Display Port*
DMA	Direct Memory Access
DMI	Direct Media Interface
DTS	Digital Thermal Sensor
ECC	Error Correction Code
Enhanced Intel SpeedStep® Technology	Technology that provides power management capabilities.
Execute Disable Bit	The Execute Disable bit allows memory to be marked as executable or non-executable, when combined with a supporting operating system. If code attempts to run in non-executable memory, the processor raises an error to the operating system. This feature can prevent some classes of viruses or worms that exploit buffer overrun vulnerabilities and can, thus, help improve the overall security of the system. See the <i>Intel® 64 and IA-32 Architectures Software Developer's Manuals</i> for more detailed information.
FCLGA	Flip Chip Land Grid Array
(G)MCH	Legacy component – Graphics Memory Controller Hub. Platforms using LGA 1156 processors do not use a (G)MCH component.
ICH	The legacy I/O Controller Hub component that contains the main PCI interface, LPC interface, USB2, Serial ATA, and other I/O functions. It communicates with the legacy (G)MCH over a proprietary interconnect called DMI. Platforms using LGA 1156 processors do not use an ICH component.
IMC	Integrated Memory Controller
Intel® 64 Technology	64-bit memory extensions to the IA-32 architecture.
Intel® Hyper-Threading Technology	The processor supports Intel® Hyper-Threading Technology (Intel® HT Technology) that allows an execution core to function as two logical processors.
Intel® Turbo Boost Technology	Intel® Turbo Boost Technology is a feature that allows the processor core to opportunistically and automatically run faster than its rated operating frequency if it is operating below power, temperature, and current limits.
Intel® TXT	Intel® Trusted Execution Technology
Intel® VT-d	Intel® Virtualization Technology (Intel® VT) for Directed I/O. Intel VT-d is a hardware assist, under system software (Virtual Machine Manager or OS) control, for enabling I/O device virtualization. VT-d also brings robust security by providing protection from errant DMAs by using DMA remapping, a key feature of Intel VT-d.
Intel® Virtualization Technology	Processor virtualization which when used in conjunction with Virtual Machine Monitor software enables multiple, robust independent software environments inside a single platform.
ITPM	Integrated Trusted Platform Module
IOV	I/O Virtualization
LCD	Liquid Crystal Display
LVDS	Low Voltage Differential Signaling. A high speed, low power data transmission standard used for display connections to LCD panels.
NCTF	Non-Critical to Function: NCTF locations are typically redundant ground or non-critical reserved, so the loss of the solder joint continuity at end of life conditions will not affect the overall product functionality.
PCH	Platform Controller Hub. The new, 2009 chipset with centralized platform capabilities including the main I/O interfaces along with display connectivity, audio features, power management, manageability, security and storage features.
PECI	Platform Environment Control Interface
PEG	PCI Express* Graphics. External Graphics using PCI Express Architecture. A high-speed serial interface whose configuration is software compatible with the existing PCI specifications.



Term	Description
Processor	The 64-bit multi-core component (package)
Processor Core	The term "processor core" refers to Si die itself which can contain multiple execution cores. Each execution core has an instruction cache, data cache, and 256-KB L2 cache. All execution cores share the L3 cache.
Rank	A unit of DRAM corresponding to four to eight devices in parallel, ignoring ECC. These devices are usually, but not always, mounted on a single side of a DIMM.
SCI	System Control Interrupt. Used in ACPI protocol.
Storage Conditions	A non-operational state. The processor may be installed in a platform, in a tray, or loose. Processors may be sealed in packaging or exposed to free air. Under these conditions, processor landings should not be connected to any supply voltages, have any I/Os biased or receive any clocks. Upon exposure to "free air" (that is, unsealed packaging or a device removed from packaging material), the processor must be handled in accordance with moisture sensitivity labeling (MSL) as indicated on the packaging material.
TAC	Thermal Averaging Constant
TDP	Thermal Design Power
TLP	Transaction Layer Packet
TOM	Top of Memory
TTM	Time-To-Market
V _{CC}	Processor core power rail
V _{SS}	Processor ground
V _{TT}	L3 shared cache, memory controller, and processor I/O power rail
V _{DDQ}	DDR3 power rail
VLD	Variable Length Decoding
x1	Refers to a Link or Port with one Physical Lane
x4	Refers to a Link or Port with four Physical Lanes
x8	Refers to a Link or Port with eight Physical Lanes
x16	Refers to a Link or Port with sixteen Physical Lanes



1.7 Related Documents

Refer to the following documents for additional information.

Table 1-2. Related Documents

Document	Document Number/ Location
<i>Intel® Core™ i7-800 and i5-700 Desktop Processor Series Datasheet, Volume 2</i>	http://download.intel.com/design/processor/datashts/322165.pdf
<i>Intel® Core™ i7-800 i5-700 Desktop Processor Series Specification Update</i>	www.intel.com/Assets/PDF/specupdate/322166.pdf
<i>Intel® Core™ i7-800 and i5-700 Desktop Processor Series and LGA1156 Socket Thermal and Mechanical Specifications and Design Guidelines</i>	http://download.intel.com/design/processor/designex/322167.pdf
<i>Intel® 5 Series Chipset and Intel® 3400 Series Chipset Datasheet</i>	www.intel.com/Assets/PDF/datasheet/322169
<i>Intel® 5 Series Chipset and Intel® 3400 Series Chipset Thermal and Mechanical Specifications and Design Guidelines</i>	www.intel.com/Assets/PDF/designguide/322171.pdf
<i>Voltage Regulator-Down (VRD) 11.1 Design Guidelines</i>	http://download.intel.com/design/processor/designex/322172.pdf
<i>Advanced Configuration and Power Interface Specification 3.0</i>	http://www.acpi.info/
<i>PCI Local Bus Specification 3.0</i>	http://www.pcisig.com/specifications
<i>PCI Express Base Specification, Revision 2.0</i>	http://www.pcisig.com
<i>DDR3 SDRAM Specification</i>	http://www.jedec.org
<i>Display Port Specification</i>	http://www.vesa.org
<i>Intel® 64 and IA-32 Architectures Software Developer's Manuals</i> <i>Volume 1: Basic Architecture</i> <i>Volume 2A: Instruction Set Reference, A-M</i> <i>Volume 2B: Instruction Set Reference, N-Z</i> <i>Volume 3A: System Programming Guide</i> <i>Volume 3B: System Programming Guide</i>	http://www.intel.com/products/processor/manuals/

§ §





2 Interfaces

This chapter describes the interfaces supported by the processor.

2.1 System Memory Interface

2.1.1 System Memory Technology Supported

The Integrated Memory Controller (IMC) supports DDR3 protocols with two independent, 64-bit wide channels. Refer to [Section 1.2.1](#) for details on the type of memory supported.

- Supported DIMM Types
 - Unbuffered DIMMs—1066 MT/s (PC3-8500), and 1333 MT/s (PC3-10600)
- Desktop Intel 5 Series Chipset platform DDR3 DIMM Modules
 - Raw Card A—Single Sided x8 unbuffered non-ECC
 - Raw Card B—Double Sided x8 unbuffered non-ECC
 - Raw Card C—Single Sided x16 unbuffered non-ECC
- DDR3 DRAM Device Technology
 - Unbuffered—1-Gb and 2-Gb DDR3 DRAM Device technologies and addressing are supported (as detailed in [Table 2-1](#)).

Table 2-1. Supported DIMM Module Configurations

Raw Card Version	DIMM Capacity	DRAM Device Technology	DRAM Organization	# of DRAM Devices	# of Physical Device Ranks	# of Row/Col Address Bits	# of Banks Inside DRAM	Page Size
Desktop Intel 5 Series Chipset Platforms: Unbuffered/Non-ECC Supported DIMM Module Configurations								
A	1 GB	1 Gb	128 M X 8	8	1	14/10	8	8 K
B	2 GB	1 Gb	128 M X 8	16	2	14/10	8	8 K
	4 GB	2 Gb	256 M X 8	16	2	15/10	8	8 K
C	512 MB	1 Gb	64 M X 16	4	1	13/10	8	8 K

Note: DIMM module support is based on availability and is subject to change.



2.1.2 System Memory Timing Support

The IMC supports the following DDR3 Speed Bin, CAS Write Latency (CWL), and command signal mode timings on the main memory interface:

- t_{CL} = CAS Latency
- t_{RCD} = Activate Command to READ or WRITE Command delay
- t_{RP} = PRECHARGE Command Period
- CWL = CAS Write Latency
- Command Signal modes = 1N indicates a new command may be issued every clock and 2N indicates a new command may be issued every 2 clocks. Command launch mode programming depends on the transfer rate and memory configuration.

Table 2-2. DDR3 System Memory Timing Support

Transfer Rate (MT/s)	t_{CL} (t_{CK})	t_{RCD} (t_{CK})	t_{RP} (t_{CK})	CWL (t_{CK})	Unbuffered DIMM CMD Mode	Registered DIMM CMD Mode	Notes
1066	7	7	7	6	See Note 1, 2, 3	1N Only	4
	8	8	8				
1333	8	8	8	7	See Note 1, 2, 3	1N Only	4
	9	9	9				4
	10	10	10				4

Note:

1. Two Un-buffered DIMM Memory Configurations = 2N Command Mode at 1066/1333 MHz
2. One Un-buffered DIMM Memory Configurations = 1N Command Mode at 1066/1333 MHz
3. Both Channel A and B will run at same Command Mode based on the slowest mode enabled relative to the memory configurations populated in both channels. For example, if Channel A has both DIMM connectors populated (2N CMD Mode) and Channel B has only one DIMM connector populated (1N CMD Mode) then 2N CMD mode would be enabled for both channels.
4. System Memory timing support is based on availability and is subject to change.

2.1.3 System Memory Organization Modes

The IMC supports two memory organization modes, single-channel and dual-channel. Depending upon how the DIMM Modules are populated in each memory channel, a number of different configurations can exist.

2.1.3.1 Single-Channel Mode

In this mode, all memory cycles are directed to a single-channel. Single-channel mode is used when either Channel A or Channel B DIMM connectors are populated, but not both.



2.1.3.2 Dual-Channel Mode—Intel® Flex Memory Technology Mode

The IMC supports Intel Flex Memory Technology mode. This mode combines the advantages of the Dual-Channel Symmetric (Interleaved) and Dual-Channel Asymmetric Modes. Memory is divided into a symmetric and an asymmetric zone. The symmetric zone starts at the lowest address in each channel and is contiguous until the asymmetric zone begins or until the top address of the channel with the smaller capacity is reached. In this mode, the system runs with one zone of dual-channel mode and one zone of single-channel mode, simultaneously, across the whole memory array.

Figure 2-1. Intel® Flex Memory Technology Operation

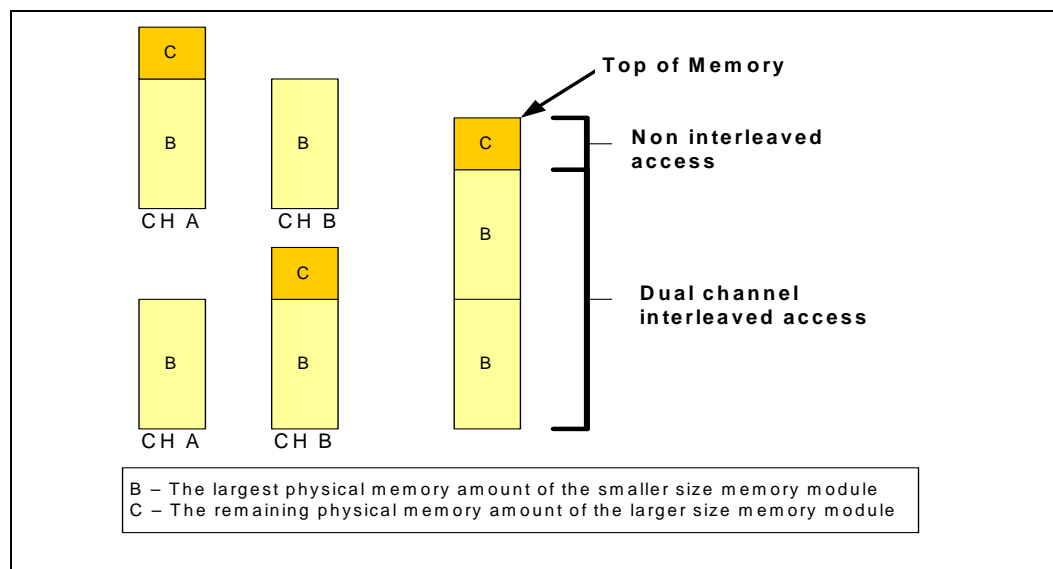

2.1.3.2.1 Dual-Channel Symmetric Mode

Dual-Channel Symmetric mode, also known as interleaved mode, provides maximum performance on real world applications. Addresses are ping-ponged between the channels after each cache line (64-byte boundary). If there are two requests, and the second request is to an address on the opposite channel from the first, that request can be sent before data from the first request has returned. If two consecutive cache lines are requested, both may be retrieved simultaneously, since they are ensured to be on opposite channels. Use Dual-Channel Symmetric mode when both Channel A and Channel B DIMM connectors are populated in any order, with the total amount of memory in each channel being the same.

When both channels are populated with the same memory capacity and the boundary between the dual channel zone and the single channel zone is the top of memory, IMC operates completely in Dual-Channel Symmetric mode.

Note: The DRAM device technology and width may vary from one channel to the other.

2.1.3.2.2 Dual-Channel Asymmetric Mode

This mode trades performance for system design flexibility. Unlike the previous mode, addresses start at the bottom of Channel A and stay there until the end of the highest rank in Channel A, and then addresses continue from the bottom of Channel B to the top. Real-world applications are unlikely to make requests that alternate between addresses that sit on opposite channels with this memory organization; thus, in most cases, bandwidth is limited to a single channel.

This mode is used when Intel Flex Memory Technology is disabled and both Channel A and Channel B DIMM connectors are populated in any order with the total amount of memory in each channel being different.

Figure 2-2. Dual-Channel Symmetric (Interleaved) and Dual-Channel Asymmetric Modes

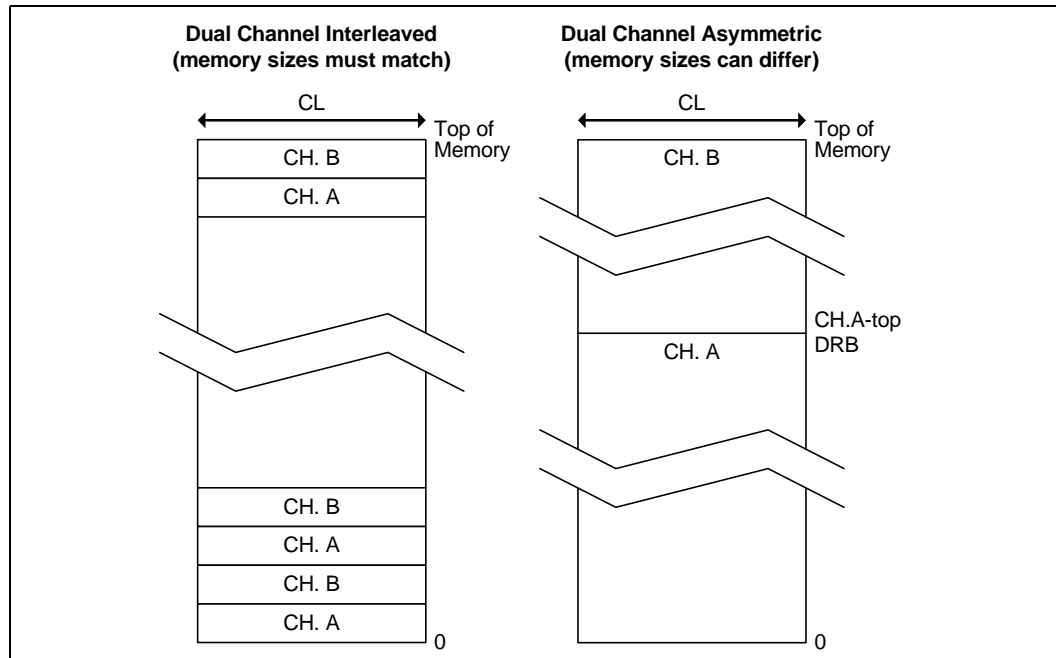

2.1.4 Rules for Populating Memory Slots

In all modes, the frequency of system memory is the lowest frequency of all memory modules placed in the system, as determined through the SPD registers on the memory modules. The system memory controller supports one or two DIMM connectors per channel for unbuffered DIMMs. For dual-channel modes, both channels must have at least one DIMM connector populated and for single-channel mode only a single-channel may have one or more DIMM connectors populated.

Note: DIMM0 must always be populated within any memory configuration. DIMM0 is the furthest DIMM within a channel and is identified by the CS#[1:0], ODT[1:0], and CKE[1:0] signals.



2.1.5 Technology Enhancements of Intel® Fast Memory Access (Intel® FMA)

The following sections describe the Just-in-Time Scheduling, Command Overlap, and Out-of-Order Scheduling Intel FMA technology enhancements.

2.1.5.1 Just-in-Time Command Scheduling

The memory controller has an advanced command scheduler where all pending requests are examined simultaneously to determine the most efficient request to be issued next. The most efficient request is picked from all pending requests and issued to system memory Just-in-Time to make optimal use of Command Overlapping. Thus, instead of having all memory access requests go individually through an arbitration mechanism forcing requests to be executed one at a time, they can be started without interfering with the current request allowing for concurrent issuing of requests. This allows for optimized bandwidth and reduced latency while maintaining appropriate command spacing to meet system memory protocol.

2.1.5.2 Command Overlap

Command Overlap allows the insertion of the DRAM commands between the Activate, Precharge, and Read/Write commands normally used, as long as the inserted commands do not affect the currently executing command. Multiple commands can be issued in an overlapping manner, increasing the efficiency of system memory protocol.

2.1.5.3 Out-of-Order Scheduling

While leveraging the Just-in-Time Scheduling and Command Overlap enhancements, the IMC continuously monitors pending requests to system memory for the best use of bandwidth and reduction of latency. If there are multiple requests to the same open page, these requests would be launched in a back to back manner to make optimum use of the open memory page. This ability to reorder requests on the fly allows the IMC to further reduce latency and increase bandwidth efficiency.

2.1.6 System Memory Pre-Charge Power Down Support Details

The IMC supports and enables the following DDR3 DRAM Device pre-charge power down DLL controls during a pre-charge power down.

- Slow Exit is where the DRAM device DLL is disabled after entering pre-charge power down
- Fast Exit is where the DRAM device DLLs are maintained after entering pre-charge power down

Table 2-3. System Memory Pre-Charge Power Down Support

DIMM per Channel Configuration	DIMM Type	Precharge Power Down Slow/Fast Exit
One	Unbuffered DIMM	Slow Exit
Two	Unbuffered DIMM	Fast Exit

2.2 PCI Express* Interface

This section describes the PCI Express interface capabilities of the processor. See the *PCI Express Base Specification* for details of PCI Express.

The number of PCI Express controllers available is dependent on the platform:

- Intel Core™ i7-800 and i5-700 desktop processor series with the desktop Intel 5 Series Chipset: 1 x16 PCI Express Graphics or 2x8 PCI Express Graphics are supported.

2.2.1 PCI Express* Architecture

Compatibility with the PCI addressing model is maintained to ensure that all existing applications and drivers operate unchanged.

The PCI Express configuration uses standard mechanisms as defined in the PCI Plug-and-Play specification. The initial recovered clock speed of 1.25 GHz results in 2.5 Gb/s/direction which provides a 250-MB/s communications channel in each direction (500 MB/s total). That is close to twice the data rate of classic PCI. The fact that 8b/10b encoding is used accounts for the 250 MB/s where quick calculations would imply 300 MB/s. The PCI Express ports support 5.0 GT/s speed as well. Operating at 5.0 GT/s results in twice as much bandwidth per lane as compared to 2.5 GT/s operation. When operating with more than one PCI Express controller, each controller can be operating at either 2.5 GT/s or 5.0 GT/s.

The PCI Express architecture is specified in three layers: Transaction Layer, Data Link Layer, and Physical Layer. The partitioning in the component is not necessarily along these same boundaries. Refer to [Figure 2-3](#) for the PCI Express Layering Diagram.

Figure 2-3. PCI Express* Layering Diagram

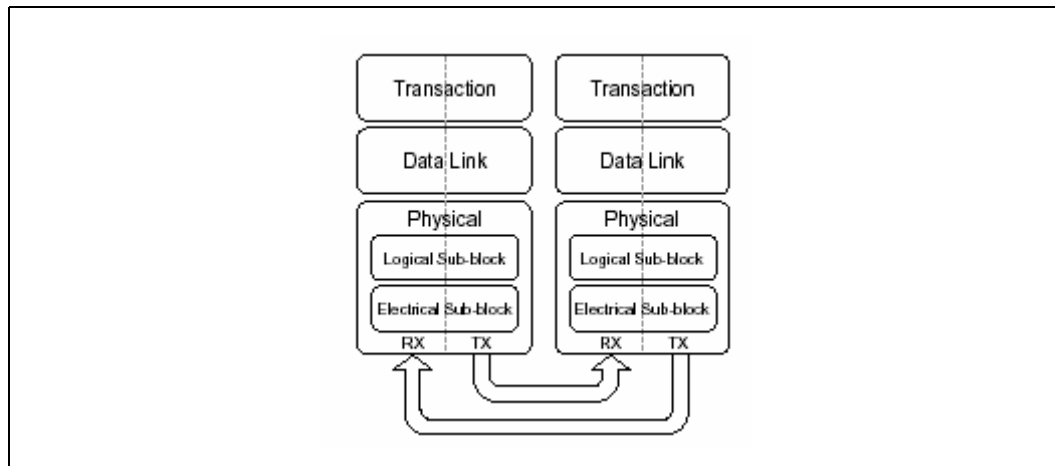

PCI Express uses packets to communicate information between components. Packets are formed in the Transaction and Data Link Layers to carry the information from the transmitting component to the receiving component. As the transmitted packets flow through the other layers, they are extended with additional information necessary to handle packets at those layers. At the receiving side the reverse process occurs and packets get transformed from their Physical Layer representation to the Data Link Layer representation and finally (for Transaction Layer Packets) to the form that can be processed by the Transaction Layer of the receiving device.

Figure 2-4. Packet Flow through the Layers

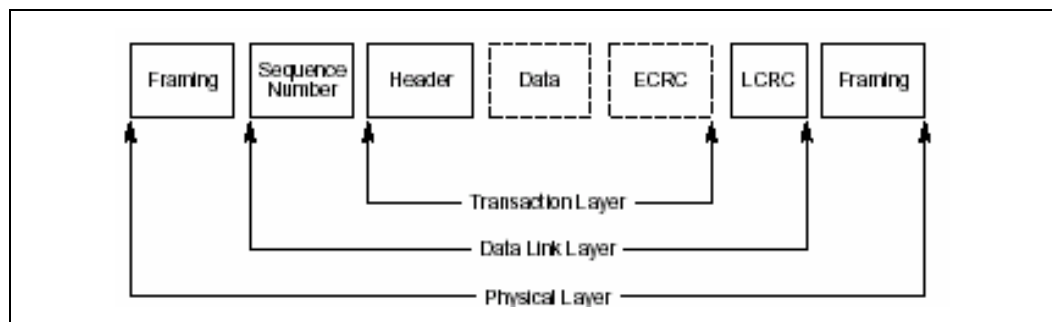

2.2.1.1 Transaction Layer

The upper layer of the PCI Express architecture is the Transaction Layer. The Transaction Layer's primary responsibility is the assembly and disassembly of Transaction Layer Packets (TLPs). TLPs are used to communicate transactions, such as read and write, as well as certain types of events. The Transaction Layer also manages flow control of TLPs.

2.2.1.2 Data Link Layer

The middle layer in the PCI Express stack, the Data Link Layer, serves as an intermediate stage between the Transaction Layer and the Physical Layer. Responsibilities of the Data Link Layer include link management, error detection, and error correction.

The transmission side of the Data Link Layer accepts TLPs assembled by the Transaction Layer, calculates and applies data protection code and TLP sequence number, and submits them to the Physical Layer for transmission across the Link. The receiving Data Link Layer is responsible for checking the integrity of received TLPs and for submitting them to the Transaction Layer for further processing. On detection of TLP error(s), this layer is responsible for requesting retransmission of TLPs until information is correctly received, or the Link is determined to have failed. The Data Link Layer also generates and consumes packets that are used for Link management functions.

2.2.1.3 Physical Layer

The Physical Layer includes all circuitry for interface operation, including driver and input buffers, parallel-to-serial and serial-to-parallel conversion, PLL(s), and impedance matching circuitry. It also includes logical functions related to interface initialization and maintenance. The Physical Layer exchanges data with the Data Link Layer in an implementation-specific format, and is responsible for converting this to an appropriate serialized format and transmitting it across the PCI Express Link at a frequency and width compatible with the remote device.

2.2.2 PCI Express* Configuration Mechanism

The PCI Express (external graphics) link is mapped through a PCI-to-PCI bridge structure.

Figure 2-5. PCI Express* Related Register Structures in Processor

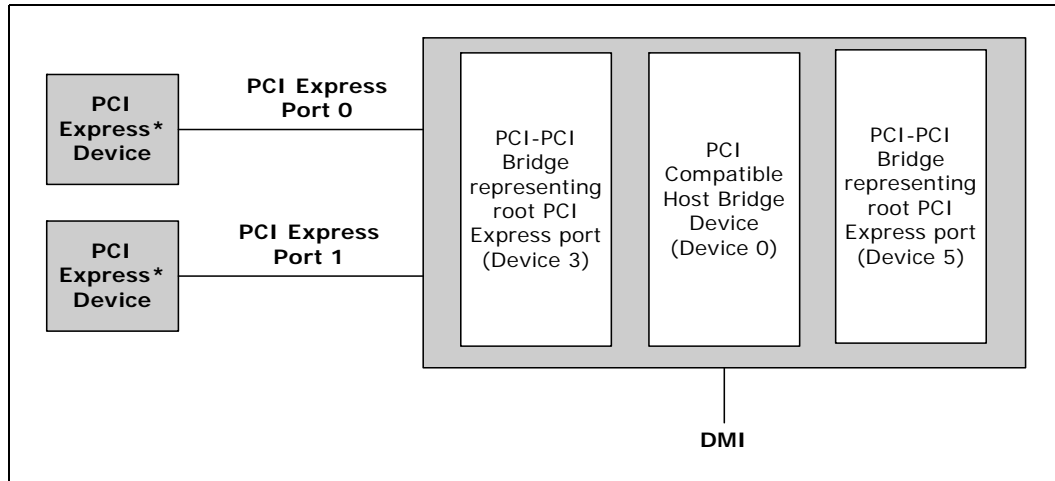

PCI Express extends the configuration space to 4096 bytes per-device/function, as compared to 256 bytes allowed by the Conventional PCI Specification. PCI Express configuration space is divided into a PCI-compatible region (consisting of the first 256 B of a logical device's configuration space) and an extended PCI Express region (consisting of the remaining configuration space). The PCI-compatible region can be accessed using either the mechanisms defined in the PCI specification or using the enhanced PCI Express configuration access mechanism described in the PCI Express Enhanced Configuration Mechanism section.

The PCI Express Host Bridge is required to translate the memory-mapped PCI Express configuration space accesses from the host processor to PCI Express configuration cycles. To maintain compatibility with PCI configuration addressing mechanisms, it is recommended that system software access the enhanced configuration space using 32-bit operations (32-bit aligned) only.

See the *PCI Express Base Specification* for details of both the PCI-compatible and PCI Express Enhanced configuration mechanisms and transaction rules.



2.2.3 PCI Express* Ports and Bifurcation

The PCI Express interface on the processor is a single 16 lane (x16) port that can also be configured at narrower widths. It may be bifurcated (refer to [Table 6-5](#)) and each port may train to narrower widths. The PCI Express port is designed to be compliant with the *PCI Express Base Specification rev 2.0*

2.2.3.1 PCI Express* Bifurcated Mode

When bifurcated, the signals that had previously been assigned to lanes 15:8 of the single x16 Primary port are reassigned to lanes 7:0 of the x8 Secondary port. This assignment applies whether the lane numbering is reversed or not. The controls for the Secondary port and the associated virtual PCI-to-PCI bridge can be found in PCI Device 5. Refer to [Table 6-5](#) for port bifurcation configuration settings and supported configurations.

When the port is not bifurcated, Device 5 is hidden from the discovery mechanism used in PCI enumeration, such that configuration of the device is neither possible nor necessary.

2.3 Direct Media Interface (DMI)

DMI connects the processor and the PCH chip-to-chip. The DMI is similar to a four-lane PCI Express supporting up to 1 GB/s of bandwidth in each direction.

Note: Only DMI x4 configuration is supported.

2.3.1 DMI Error Flow

DMI can only generate SERR in response to errors—never SCI, SMI, MSI, PCI INT, or GPE. Any DMI related SERR activity is associated with Device 0.

2.3.2 Processor/PCH Compatibility Assumptions

The processor is compatible with the PCH and is not compatible with any previous (G)MCH or ICH products.

2.3.3 DMI Link Down

The DMI link going down is a fatal, unrecoverable error. If the DMI data link goes to data link down, after the link was up, then the DMI link hangs the system by not allowing the link to retrain to prevent data corruption. This is controlled by the PCH.

Downstream transactions that had been successfully transmitted across the link prior to the link going down may be processed as normal. No completions from downstream, non-posted transactions are returned upstream over the DMI link after a link down event.



2.4 Platform Environment Control Interface (PECI)

The PECI is a one-wire interface that provides a communication channel between processor and a PECI master, usually the PCH. The processor implements a PECI interface to:

- Allow communication of processor thermal and other information to the PECI master.
- Read averaged Digital Thermal Sensor (DTS) values for fan speed control.

2.5 Interface Clocking

2.5.1 Internal Clocking Requirements

Table 2-4. Processor Reference Clock Requirements

Reference Input Clocks	Input Frequency	Associated PLL
BCLK[0]/BCLK#[0]	133 MHz	Processor/Memory
PEG_CLK/PEG_CLK#	100 MHz	PCI Express/DMI

§ §



3 Technologies

3.1 Intel® Virtualization Technology

Intel Virtualization Technology (Intel VT) makes a single system appear as multiple independent systems to software. This allows multiple, independent operating systems to run simultaneously on a single system. Intel VT comprises technology components to support virtualization of platforms based on Intel architecture microprocessors and chipsets. Intel Virtualization Technology (Intel VT-x) added hardware support in the processor to improve the virtualization performance and robustness. Intel Virtualization Technology for Directed I/O (Intel VT-d) adds chipset hardware implementation to support and improve I/O virtualization performance and robustness.

Intel VT-x specifications and functional descriptions are included in the *Intel® 64 and IA-32 Architectures Software Developer's Manual, Volume 3B* and is available at: <http://www.intel.com/products/processor/manuals/index.htm>.

The Intel VT-d spec and other VT documents can be referenced at: <http://www.intel.com/technology/virtualization/index.htm>.

3.1.1 Intel® VT-x Objectives

Intel VT-x provides hardware acceleration for virtualization of IA platforms. Virtual Machine Monitor (VMM) can use Intel VT-x features to provide improved reliable virtualized platforms. By using Intel VT-x, a VMM is:

- **Robust**—VMMs no longer need to use paravirtualization or binary translation. This means that they will be able to run off-the-shelf OSs and applications without any special steps.
- **Enhanced**—Intel VT enables VMMs to run 64-bit guest operating systems on IA x86 processors.
- **More reliable**—Due to the hardware support, VMMs can now be smaller, less complex, and more efficient. This improves reliability and availability and reduces the potential for software conflicts.
- **More secure**—The use of hardware transitions in the VMM strengthens the isolation of VMs and further prevents corruption of one VM from affecting others on the same system.

3.1.2 Intel® VT-x Features

The processor core supports the following Intel VT-x features:

- Extended Page Tables (EPT)
 - EPT is hardware assisted page table virtualization
 - It eliminates VM exits from guest OS to the VMM for shadow page-table maintenance
- Virtual Processor IDs (VPID)
 - Ability to assign a VM ID to tag processor core hardware structures (such as TLBs)
 - This avoids flushes on VM transitions to give a lower-cost VM transition time and an overall reduction in virtualization overhead.



- Guest Preemption Timer
 - Mechanism for a VMM to preempt the execution of a guest OS after an amount of time specified by the VMM. The VMM sets a timer value before entering a guest
 - The feature aids VMM developers in flexibility and Quality of Service (QoS) guarantees
- Descriptor-Table Exiting
 - Descriptor-table exiting allows a VMM to protect a guest OS from internal (malicious software based) attack by preventing relocation of key system data structures like IDT (interrupt descriptor table), GDT (global descriptor table), LDT (local descriptor table), and TSS (task segment selector).
 - A VMM using this feature can intercept (by a VM exit) attempts to relocate these data structures and prevent them from being tampered by malicious software.

3.1.3 Intel® VT-d Objectives

The key Intel VT-d objectives are domain-based isolation and hardware-based virtualization. A domain can be abstractly defined as an isolated environment in a platform to which a subset of host physical memory is allocated. Virtualization allows for the creation of one or more partitions on a single system. This could be multiple partitions in the same operating system, or there can be multiple operating system instances running on the same system—offering benefits such as system consolidation, legacy migration, activity partitioning, or security.

3.1.4 Intel® VT-d Features

The processor supports the following Intel VT-d features:

- 48-bit maximum guest address width and 36-bit maximum host address width for non-isoch traffic, in UP profiles
- 39-bit maximum guest address width and 36-bit maximum host address width for isoch (Intel High Definition Audio isoch) traffic
- Support for 4K page sizes only
- Support for register-based fault recording only (for single entry only) and support for MSI interrupts for faults
 - Support for fault collapsing based on Requester ID
- Support for both leaf and non-leaf caching
- Support for boot protection of default page table
- Support for non-caching of invalid page table entries
- Support for hardware based flushing of translated but pending writes and pending reads, on IOTLB invalidation
- Support for page-selective IOTLB invalidation
- Support for queue-based invalidation interface
- Support for Intel VT-d read prefetching/snarfing (such as, translations within a cacheline are stored in an internal buffer for reuse for subsequent transactions)
- Support for ARI (Alternate Requester ID—a PCI SIG ECR for increasing the function number count in a PCI Express device) to support IOV devices



3.1.5 Intel® VT-d Features Not Supported

The following features are not supported by the processor with Intel VT-d:

- No support for PCISIG endpoint caching (ATS)
- No support for interrupt remapping
- No support for advance fault reporting
- No support for super pages
- No support for 1 or 2 level page walks for isoch remap engine and 1, 2, or 3 level walks for non-isoch remap engine
- No support for Intel VT-d translation bypass address range (such usage models need to be resolved with VMM help in setting up the page tables correctly)

3.2 Intel® Trusted Execution Technology (Intel® TXT)

Intel Trusted Execution Technology (Intel TXT) defines platform-level enhancements that provide the building blocks for creating trusted platforms.

The Intel TXT platform helps to provide the authenticity of the controlling environment such that those wishing to rely on the platform can make an appropriate trust decision. The Intel TXT platform determines the identity of the controlling environment by accurately measuring and verifying the controlling software.

Another aspect of the trust decision is the ability of the platform to resist attempts to change the controlling environment. The Intel TXT platform will resist attempts by software processes to change the controlling environment or bypass the bounds set by the controlling environment.

Intel TXT is a set of extensions designed to provide a measured and controlled launch of system software that will then establish a protected environment for itself and any additional software that it may execute.

These extensions enhance two areas:

- The launching of the Measured Launched Environment (MLE).
- The protection of the MLE from potential corruption.

The enhanced platform provides these launch and control interfaces using Safer Mode Extensions (SMX).

The SMX interface includes the following functions:

- Measured/Verified launch of the MLE.
- Mechanisms to ensure the above measurement is protected and stored in a secure location.
- Protection mechanisms that allow the MLE to control attempts to modify itself.



3.3 Intel® Hyper-Threading Technology

The processor supports Intel® Hyper-Threading Technology (Intel® HT Technology) that allows an execution core to function as two logical processors. While some execution resources such as caches, execution units, and buses are shared, each logical processor has its own architectural state with its own set of general-purpose registers and control registers. This feature must be enabled using the BIOS and requires operating system support.

Intel recommends enabling Hyper-Threading Technology with Microsoft Windows Vista*, Microsoft Windows* XP Professional/Windows* XP Home, and disabling Hyper-Threading Technology using the BIOS for all previous versions of Windows operating systems. For more information on Hyper-Threading Technology, see: http://www.intel.com/products/ht/hyperthreading_more.htm.

3.4 Intel® Turbo Boost Technology

Intel® Turbo Boost Technology is a feature that allows the processor core to opportunistically and automatically run faster than its rated operating frequency if it is operating below power, temperature, and current limits. Maximum frequency is dependent on the SKU and number of active cores. No special hardware support is necessary for Intel Turbo Boost Technology. BIOS and the operating system can enable or disable Intel Turbo Boost Technology.

Note: Intel Turbo Boost Technology may not be available on all SKUs. Refer to the processor specification update for details.





4 Power Management

This chapter provides information on the following power management topics:

- ACPI States
- Processor Core
- IMC
- PCI Express*

4.1 ACPI States Supported

The ACPI states supported by the processor are described in this section.

4.1.1 System States

State	Description
G0/S0	Full On
G1/S3-Cold	Suspend-to-RAM (STR). Context saved to memory (S3-Hot is not supported by the processor).
G1/S4	Suspend-to-Disk (STD). All power lost (except wakeup on PCH).
G2/S5	Soft off. All power lost (except wakeup on PCH). Total reboot.
G3	Mechanical off. All power removed from system.

4.1.2 Processor Core/Package Idle States

Table 4-1. Processor Core/Package State Support

State	Description
C0	Active mode, processor executing code.
C1	AutoHALT state.
C1E	AutoHALT state with lowest frequency and voltage operating point.
C3	Execution cores in C3 flush their L1 instruction cache, L1 data cache, and L2 cache to the L3 shared cache. Clocks are shut off to the core.
C6	Execution cores in this state save their architectural state before removing core voltage.

4.1.3 Integrated Memory Controller States

State	Description
Power up	CKE asserted. Active mode.
Pre-charge Power down	CKE de-asserted (not self-refresh) with all banks closed.
Active Power down	CKE de-asserted (not self-refresh) with minimum one bank active.
Self-Refresh	CKE de-asserted using device self-refresh.



4.1.4 PCI Express* Link States

State	Description
L0	Full on – Active transfer state.
L0s	First Active Power Management low power state – Low exit latency.
L1	Lowest Active Power Management - Longer exit latency.
L3	Lowest power state (power-off) – Longest exit latency.

4.1.5 Interface State Combinations

Table 4-2. G, S, and C State Combinations

Global (G) State	Sleep (S) State	Processor Core (C) State	Processor State	System Clocks	Description
G0	S0	C0	Full On	On	Full On
G0	S0	C1/C1E	Auto-Halt	On	Auto-Halt
G0	S0	C3	Deep Sleep	On	Deep Sleep
G0	S0	C6	Deep Power Down	On	Deep Power Down
G1	S3	Power off	Power off	Off, except RTC	Suspend to RAM
G1	S4	Power off	Power off	Off, except RTC	Suspend to Disk
G2	S5	Power off	Power off	Off, except RTC	Soft Off
G3	NA	Power off	Power off	Power off	Hard off

4.2 Processor Core Power Management

While executing code, Enhanced Intel SpeedStep Technology optimizes the processor's frequency and core voltage based on workload. Each frequency and voltage operating point is defined by ACPI as a P-state. When the processor is not executing code, it is idle. A low-power idle state is defined by ACPI as a C-state. In general, lower power C-states have longer entry and exit latencies.

4.2.1 Enhanced Intel® SpeedStep® Technology

The following are the key features of Enhanced Intel SpeedStep Technology:

- Multiple frequency and voltage points for optimal performance and power efficiency. These operating points are known as P-states.
- Frequency selection is software controlled by writing to processor MSRs. The voltage is optimized based on the selected frequency and the number of active processor cores.
 - If the target frequency is higher than the current frequency, V_{CC} is ramped up in steps to an optimized voltage. This voltage is signaled by the VID[7:0] pins to the voltage regulator. Once the voltage is established, the PLL locks on to the target frequency.
 - If the target frequency is lower than the current frequency, the PLL locks to the target frequency, then transitions to a lower voltage by signaling the target voltage on the VID[7:0] pins.



- All active processor cores share the same frequency and voltage. In a multi-core processor, the highest frequency P-state requested amongst all active cores is selected.
- Software-requested transitions are accepted at any time. If a previous transition is in progress, the new transition is deferred until the previous transition is completed.
- The processor controls voltage ramp rates internally to ensure glitch-free transitions.
- Because there is low transition latency between P-states, a significant number of transitions per second are possible.

4.2.2 Low-Power Idle States

When the processor is idle, low-power idle states (C-states) are used to save power. More power savings actions are taken for numerically higher C-states. However, higher C-states have longer exit and entry latencies. Resolution of C-states occur at the thread, processor core, and processor package level. Thread level C-states are available if Intel Hyper-Threading Technology is enabled.

Figure 4-1. Idle Power Management Breakdown of the Processor Cores

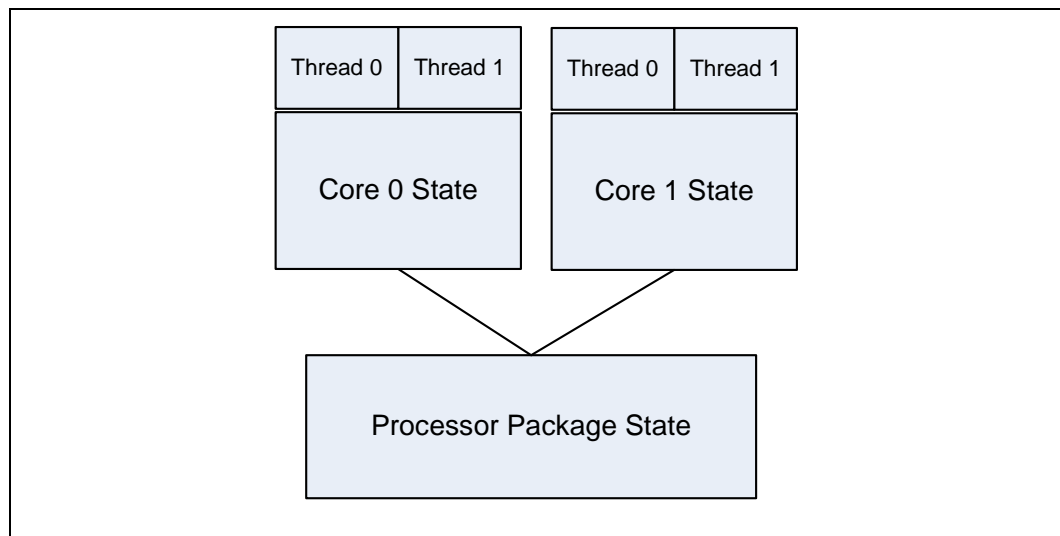

Entry and exit of the C-States at the thread and core level are shown in Figure 4-2.

Figure 4-2. Thread and Core C-State Entry and Exit

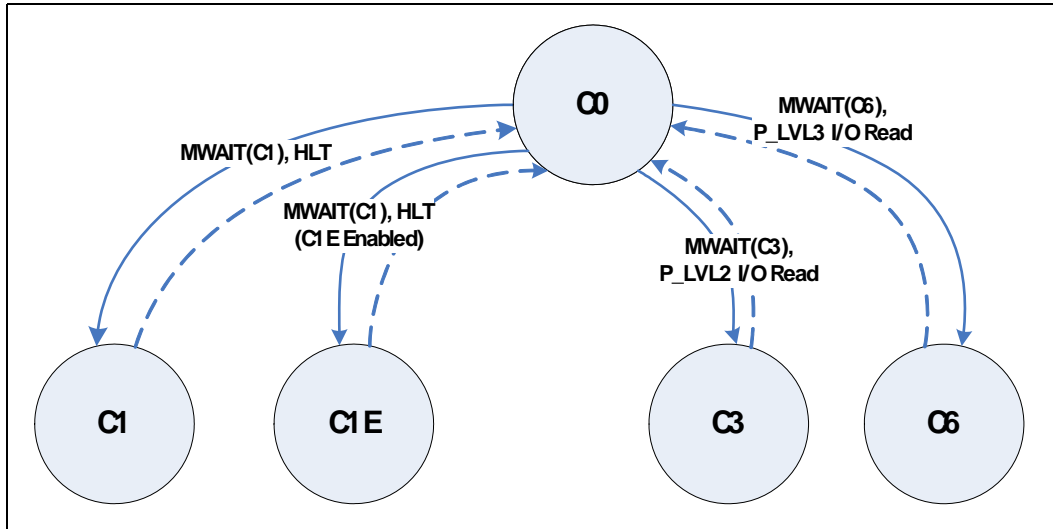

While individual threads can request low power C-states, power saving actions only take place once the core C-state is resolved. Core C-states are automatically resolved by the processor. For thread and core C-states, a transition to and from C0 is required before entering any other C-state.

Table 4-3. Coordination of Thread Power States at the Core Level

Processor Core C-State		Thread 1			
		C0	C1	C3	C6
Thread 0	C0	C0	C0	C0	C0
	C1	C0	C1 ¹	C1 ¹	C1 ¹
	C3	C0	C1 ¹	C3	C3
	C6	C0	C1 ¹	C3	C6

Note:

1. If enabled, the core C-state will be C1E if all active cores have also resolved to a core C1 state or higher.

4.2.3 Requesting Low-Power Idle States

The primary software interfaces for requesting low-power idle states are through the MWAIT instruction with sub-state hints and the HLT instruction (for C1 and C1E). However, software may make C-state requests using the legacy method of I/O reads from the ACPI-defined processor clock control registers, referred to as P_LVLx. This method of requesting C-states provides legacy support for operating systems that initiate C-state transitions using I/O reads.

For legacy operating systems, P_LVLx I/O reads are converted within the processor to the equivalent MWAIT C-state request. Therefore, P_LVLx reads do not directly result in I/O reads to the system. The feature, known as I/O MWAIT redirection, must be enabled in the BIOS.



Note: The P_LVLx I/O Monitor address needs to be set up before using the P_LVLx I/O read interface. Each P_LVLx is mapped to the supported MWAIT(Cx) instruction as follows:

Table 4-4. P_LVLx to MWAIT Conversion

P_LVLx	MWAIT(Cx)	Notes
P_LVL2	MWAIT(C3)	
P_LVL3	MWAIT(C6)	C6. No sub-states allowed

The BIOS can write to the C-state range field of the PMG_IO_CAPTURE MSR to restrict the range of I/O addresses that are trapped and emulate MWAIT like functionality. Any P_LVLx reads outside of this range does not cause an I/O redirection to MWAIT(Cx) like request. They fall through like a normal I/O instruction.

Note: When P_LVLx I/O instructions are used, MWAIT substates cannot be defined. The MWAIT substate is always zero if I/O MWAIT redirection is used. By default, P_LVLx I/O redirections enable the MWAIT 'break on EFLAGS.IF' feature that triggers a wakeup on an interrupt, even if interrupts are masked by EFLAGS.IF.

4.2.4 Core C-states

The following are general rules for all core C-states, unless specified otherwise:

- A core C-State is determined by the lowest numerical thread state (such that, Thread 0 requests C1E while thread1 requests C3, resulting in a core C1E state). See [Table 4-3](#).
- A core transitions to C0 state when:
 - an interrupt occurs.
 - there is an access to the monitored address if the state was entered using an MWAIT instruction.
- For core C1/C1E, and core C3, an interrupt directed toward a single thread wakes only that thread. However, since both threads are no longer at the same core C-state, the core resolves to C0.
- For core C6, an interrupt coming into either thread wakes both threads into C0 state.
- Any interrupt coming into the processor package may wake any core.

4.2.4.1 Core C0 State

The normal operating state of a core where code is being executed.

4.2.4.2 Core C1/C1E State

C1/C1E is a low power state entered when all threads within a core execute a HLT or MWAIT(C1/C1E) instruction.

A System Management Interrupt (SMI) handler returns execution to either Normal state or the C1/C1E state. See the *Intel® 64 and IA-32 Architecture Software Developer's Manual, Volume 3A/3B: System Programmer's Guide* for more information.

While a core is in C1/C1E state, it processes bus snoops and snoops from other threads. For more information on C1E, see [Section 4.2.5.2](#).



4.2.4.3 Core C3 State

Individual threads of a core can enter the C3 state by initiating a P_LVL2 I/O read to the P_BLK or an MWAIT(C3) instruction. A core in C3 state flushes the contents of its L1 instruction cache, L1 data cache, and L2 cache to the shared L3 cache, while maintaining its architectural state. All core clocks are stopped at this point. Because the core's caches are flushed, the processor does not wake any core that is in the C3 state when either a snoop is detected or when another core accesses cacheable memory.

4.2.4.4 Core C6 State

Individual threads of a core can enter the C6 state by initiating a P_LVL3 I/O read or an MWAIT(C6) instruction. Before entering core C6, the core will save its architectural state to a dedicated SRAM. Once complete, a core will have its voltage reduced to zero volts. During exit, the core is powered on and its architectural state is restored.

4.2.4.5 C-State Auto-Demotion

In general, deeper C-states, such as C6, have long latencies and have higher energy entry/exit costs. The resulting performance and energy penalties become significant when the entry/exit frequency of a deeper C-state is high.

Therefore, incorrect or inefficient usage of deeper C-states may have a negative impact on power consumption. To increase residency and improve power consumption in deeper C-states, the processor supports C-state auto-demotion.

There are two C-State auto-demotion options:

- C6 to C3
- C6/C3 To C1

The decision to demote a core from C6 to C3 or C3/C6 to C1 is based on each core's residency history. Requests to deeper C-states are demoted to shallower C-states when the original request doesn't make sense from a performance or energy perspective.

This feature is disabled by default. BIOS must enable it in the PMG_CST_CONFIG_CONTROL register. The auto-demotion policy is also configured by this register.

4.2.5 Package C-States

The processor supports C0, C1/C1E, C3, and C6 power states. The following is a summary of the general rules for package C-state entry. These apply to all package C-states unless specified otherwise:

- A package C-state request is determined by the lowest numerical core C-state amongst all cores.
- A package C-state is automatically resolved by the processor depending on the core idle power states and the status of the platform components.
 - Each core can be at a lower idle power state than the package if the platform does not grant the processor permission to enter a requested package C-state.
 - The platform may allow additional power savings to be realized in the processor. The processor will put the DRAM into self-refresh in the package C3 and C6 states.
- For package C-states, the processor is not required to enter C0 before entering any other C-state.



The processor exits a package C-state when a break event is detected. If DRAM was allowed to go into self-refresh in package C3 or C6 state, it will be taken out of self-refresh. Depending on the type of break event, the processor does the following:

- If a core break event is received, the target core is activated and the break event message is forwarded to the target core.
 - If the break event is not masked, the target core enters the core C0 state and the processor enters package C0.
 - If the break event is masked, the processor attempts to re-enter its previous package state.
- If the break event was due to a memory access or snoop request.
 - But the platform did not request to keep the processor in a higher package C-state, the package returns to its previous C-state.
 - And the platform requests a higher power C-state, the memory access or snoop request is serviced and the package remains in the higher power C-state.

Table 4-5 shows an example package C-state resolution for a dual-core processor. Figure 4-3 summarizes package C-state transitions.

Table 4-5. Coordination of Core Power States at the Package Level

Package C-State		Core 1			
		C0	C1 ¹	C3	C6
Core 0	C0	C0	C0	C0	C0
	C1 ¹	C0	C1 ¹	C1 ¹	C1 ¹
	C3	C0	C1 ¹	C3	C3
	C6	C0	C1 ¹	C3	C6

Note:

1. If enabled, the package C-state will be C1E if all active cores have resolved a core C1 state or higher.

Figure 4-3. Package C-State Entry and Exit

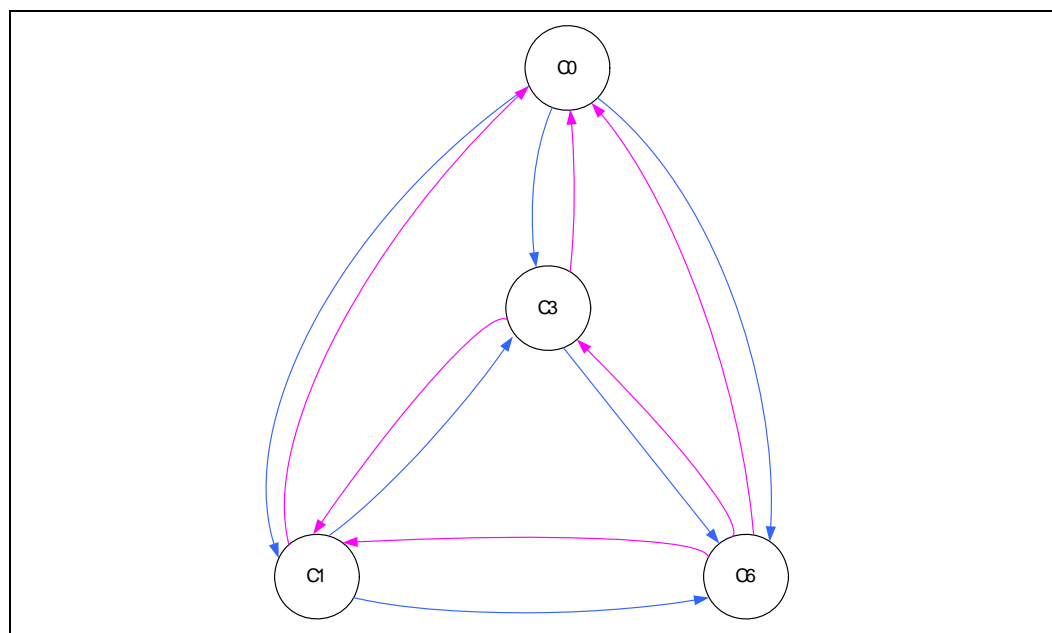



4.2.5.1 Package C0

The normal operating state for the processor. The processor remains in the normal state when at least one of its cores is in the C0 or C1 state or when the platform has not granted permission to the processor to go into a low power state. Individual cores may be in lower power idle states while the package is in C0.

4.2.5.2 Package C1/C1E

No additional power reduction actions are taken in the package C1 state. However, if the C1E sub-state is enabled, the processor automatically transitions to the lowest supported core clock frequency, followed by a reduction in voltage.

The package enters the C1 low power state when:

- At least one core is in the C1 state.
- The other cores are in a C1 or lower power state.

The package enters the C1E state when:

- All cores have directly requested C1E using MWAIT(C1) with a C1E sub-state hint.
- All cores are in a power state lower than C1/C1E but the package low power state is limited to C1/C1E using the PMG_CST_CONFIG_CONTROL MSR.
- All cores have requested C1 using HLT or MWAIT(C1) and C1E auto-promotion is enabled in IA32_MISC_ENABLES.

No notification to the system occurs upon entry to C1/C1E.

4.2.5.3 Package C3 State

A processor enters the package C3 low power state when:

- At least one core is in the C3 state.
- The other cores are in a C3 or lower power state, and the processor has been granted permission by the platform.
- The processor has requested the C6 state, but the platform only allowed C3.

In package C3-state, the L3 shared cache is snoopable.

4.2.5.4 Package C6 State

A processor enters the package C6 low power state when:

- At least one core is in the C6 state.
- The other cores are in a C6 state, and the processor has been granted permission by the platform.

In package C6 state, all cores save their architectural state and have their core voltages reduced. The L3 shared cache is still powered and snoopable in this state.



4.3 Integrated Memory Controller (IMC) Power Management

The main memory is power managed during normal operation and in low power ACPI Cx states.

4.3.1 Disabling Unused System Memory Outputs

Any system memory (SM) interface signal that goes to a memory module connector in which it is not connected to any actual memory devices (such as, DIMM connector is unpopulated, or is single-sided) is tristated. The benefits of disabling unused SM signals are:

- Reduced power consumption.
- Reduced possible overshoot/undershoot signal quality issues seen by the processor I/O buffer receivers caused by reflections from potentially un-terminated transmission lines.

When a given rank is not populated, the corresponding chip select and SCKE signals are not driven.

At reset, all rows must be assumed to be populated, until it can be proven that they are not populated. This is due to the fact that when CKE is tristated with a DIMM present, the DIMM is not ensured to maintain data integrity.

4.3.2 DRAM Power Management and Initialization

The processor implements extensive support for power management on the SDRAM interface. There are four SDRAM operations associated with the Clock Enable (CKE) signals, which the SDRAM controller supports. The processor drives four CKE pins to perform these operations.

4.3.2.1 Initialization Role of CKE

During power-up, CKE is the only input to the SDRAM that has its level recognized (other than the DDR3 reset pin) once power is applied. It must be driven LOW by the DDR controller to make sure the SDRAM components float DQ and DQS during power-up. CKE signals remain LOW (while any reset is active) until the BIOS writes to a configuration register. Using this method, CKE is ensured to remain inactive for much longer than the specified 200 micro-seconds after power and clocks to SDRAM devices are stable.

4.3.2.2 Conditional Self-Refresh

The processor conditionally places memory into self-refresh in the C3 and C6 low power states.

When entering the Suspend-to-RAM (STR) state, the processor core flushes pending cycles and then enters all SDRAM ranks into self refresh. In STR, the CKE signals remain LOW so the SDRAM devices perform self refresh.

The target behavior is to enter self-refresh for the package C3 and C6 states as long as there are no memory requests to service. The target usage is shown in [Table 4-6](#).



Table 4-6. Targeted Memory State Conditions

Mode	Memory State with External Graphics
C0, C1, C1E	Dynamic memory rank power down based on idle conditions.
C3, C6	Dynamic memory rank power down based on idle conditions If there are no memory requests, then enter self-refresh. Otherwise, use dynamic memory rank power down based on idle conditions.
S3	Self Refresh Mode
S4	Memory power down (contents lost)

4.3.2.3 Dynamic Power Down Operation

Dynamic power-down of memory is employed during normal operation. Based on idle conditions, a given memory rank may be powered down. The IMC implements aggressive CKE control to dynamically put the DRAM devices in a power down state. The processor core controller can be configured to put the devices in *active power down* (CKE de-assertion with open pages) or *precharge power down* (CKE de-assertion with all pages closed). Precharge power down provides greater power savings but has a bigger performance impact, since all pages will first be closed before putting the devices in power down mode.

If dynamic power-down is enabled, all ranks are powered up before doing a refresh cycle and all ranks are powered down at the end of refresh.

4.3.2.4 DRAM I/O Power Management

Unused signals should be disabled to save power and reduce electromagnetic interference. This includes all signals associated with an unused memory channel. Clocks can be controlled on a per DIMM basis. Exceptions are made for per DIMM control signals, such as CS#, CKE, and ODT for unpopulated DIMM slots.

The I/O buffer for an unused signal should be tristated (output driver disabled), the input receiver (differential sense-amp) should be disabled, and any DLL circuitry related ONLY to unused signals should be disabled. The input path must be gated to prevent spurious results due to noise on the unused signals (typically handled automatically when input receiver is disabled).

4.4 PCI Express* Power Management

- Active power management support using L0s, and L1 states.
- All inputs and outputs disabled in L3 Ready state.

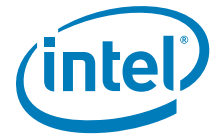

5 Thermal Management

For thermal specifications and design guidelines, refer to the appropriate Thermal and Mechanical Specifications and Design Guidelines (see [Section 1.7](#)).

§ §





6 Signal Description

This chapter describes the processor signals. They are arranged in functional groups according to their associated interface or category. The following notations are used to describe the signal type.

Notations	Signal Type
I	Input Pin
O	Output Pin
I/O	Bi-directional Input/Output Pin

The signal description also includes the type of buffer used for the particular signal.

Table 6-1. Signal Description Buffer Types

Signal	Description
PCI Express*	PCI Express* interface signals. These signals are compatible with the PCI Express 2.0 Signaling Environment AC Specifications and are AC Coupled. The buffers are not 3.3 V tolerant. Refer to the PCI Express Specification.
FDI	Intel Flexible Display Interface signals. These signals are compatible with PCI Express 2.0 Signaling Environment AC Specifications, but are DC coupled. The buffers are not 3.3 V tolerant.
DMI	Direct Media Interface signals. These signals are compatible with PCI Express 2.0 Signaling Environment AC Specifications, but are DC coupled. The buffers are not 3.3 V tolerant.
CMOS	CMOS buffers. 1.1 V tolerant
DDR3	DDR3 buffers: 1.5 V tolerant
GTL	Gunning Transceiver Logic signaling technology
TAP	Test Access Port signal
Analog	Analog reference or output. May be used as a threshold voltage or for buffer compensation.
Ref	Voltage reference signal
Asynch	This signal is asynchronous and has no timing relationship with any reference clock.

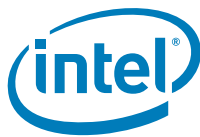

6.1 System Memory Interface

Table 6-2. Memory Channel A

Signal Name	Description	Direction	Type
SA_BS[2:0]	Bank Select: These signals define which banks are selected within each SDRAM rank.	O	DDR3
SA_CAS#	CAS Control Signal: This signal is used with SA_RAS# and SA_WE# (along with SA_CS#) to define the SDRAM Commands.	O	DDR3
SA_CK#[1:0]	SDRAM Inverted Differential Clock: Channel A SDRAM Differential clock signal-pair complement.	O	DDR3
SA_CK#[3:2]	SDRAM Inverted Differential Clock: Channel A SDRAM Differential clock signal-pair complement.	O	DDR3
SA_CK[1:0]	SDRAM Differential Clock: Channel A SDRAM Differential clock signal pair. The crossing of the positive edge of SA_CKx and the negative edge of its complement SA_CKx# are used to sample the command and control signals on the SDRAM.	O	DDR3
SA_CK[3:2]	SDRAM Differential Clock: Channel A SDRAM Differential clock signal pair. The crossing of the positive edge of SA_CKx and the negative edge of its complement SA_CKx# are used to sample the command and control signals on the SDRAM.	O	DDR3
SA_CKE[3:0]	Clock Enable: (1 per rank). These signals are used to: <ul style="list-style-type: none"> • Initialize the SDRAMs during power-up • Power-down SDRAM ranks • Place all SDRAM ranks into and out of self-refresh during STR 	O	DDR3
SA_CS#[3:0]	Chip Select: (1 per rank) These signals are used to select particular SDRAM components during the active state. There is one Chip Select for each SDRAM rank.	O	DDR3
SA_CS#[7:4]	These signals are only used for processors and platforms that have Registered DIMM support. These signals are used to select particular SDRAM components during the active state and SA_CS#[7:6] are used as the on die termination for the first DIMM.	O	DDR3
SA_DM[7:0]	Data Mask: These signals are used to mask individual bytes of data in the case of a partial write, and to interrupt burst writes. When activated during writes, the corresponding data groups in the SDRAM are masked. There is one SA_DM[7:0] for every data byte lane. Note: These signals are not used by the Intel Core™ i7-800 and i5-700 desktop processor series. They are connected to V _{SS} on the package.		
SA_DQ[63:0]	Data Bus: Channel A data signal interface to the SDRAM data bus.	I/O	DDR3
SA_DQS[8:0] SA_DQS#[8:0]	Data Strobes: SA_DQS[8:0] and its complement signal group make up a differential strobe pair. The data is captured at the crossing point of SA_DQS[8:0] and its SA_DQS#[8:0] during read and write transactions.	I/O	DDR3
SA_ECC_CB[7:0]	Data Lines for ECC Check Byte.	I/O	DDR3
SA_MA[15:0]	Memory Address: These signals are used to provide the multiplexed row and column address to the SDRAM.	O	DDR3
SA_ODT[3:0]	On Die Termination: Active Termination Control	O	DDR3
SA_RAS#	RAS Control Signal: This signal is used with SA_CAS# and SA_WE# (along with SA_CS#) to define the SRAM Commands.	O	DDR3
SA_WE#	Write Enable Control Signal: This signal is used with SA_RAS# and SA_CAS# (along with SA_CS#) to define the SDRAM Commands.	O	DDR3



Table 6-3. Memory Channel B

Signal Name	Description	Direction	Type
SB_BS[2:0]	Bank Select: These signals define which banks are selected within each SDRAM rank.	O	DDR3
SB_CAS#	CAS Control Signal: This signal is used with SB_RAS# and SB_WE# (along with SB_CS#) to define the SDRAM Commands.	O	DDR3
SB_CK#[1:0]	SDRAM Inverted Differential Clock: Channel B SDRAM Differential clock signal-pair complement.	O	DDR3
SB_CK#[3:2]	SDRAM Inverted Differential Clock: Channel B SDRAM Differential clock signal-pair complement.	O	DDR3
SB_CK[1:0]	SDRAM Differential Clock: Channel B SDRAM Differential clock signal pair. The crossing of the positive edge of SB_CKx and the negative edge of its complement SB_CKx# are used to sample the command and control signals on the SDRAM.	O	DDR3
SB_CK[3:2]	SDRAM Differential Clock: Channel B SDRAM Differential clock signal pair. The crossing of the positive edge of SB_CKx and the negative edge of its complement SB_CKx# are used to sample the command and control signals on the SDRAM.	O	DDR3
SB_CKE[3:0]	Clock Enable: (1 per rank). These signals are used to: <ul style="list-style-type: none"> Initialize the SDRAMs during power-up Power-down SDRAM ranks Place all SDRAM ranks into and out of self-refresh during STR 	O	DDR3
SB_CS#[3:0]	Chip Select: (1 per rank) These signals are used to select particular SDRAM components during the active state. There is one Chip Select for each SDRAM rank.	O	DDR3
SB_CS#[7:4]	These signals are only used for processors and platforms that have Registered DIMM support. These signals are used to select particular SDRAM components during the active state and SB_CS#[7:6] are used as the on die termination for the first DIMM.	O	DDR3
SB_DM[7:0]	Data Mask: These signals are used to mask individual bytes of data in the case of a partial write, and to interrupt burst writes. When activated during writes, the corresponding data groups in the SDRAM are masked. There is one SB_DM[7:0] for every data byte lane. Note: These signals are not used by the Intel Core™ i7-800 and i5-700 desktop processor series. They are connected to V _{SS} on the package.		
SB_DQ[63:0]	Data Bus: Channel B data signal interface to the SDRAM data bus.	I/O	DDR3
SB_DQS[8:0] SB_DQS#[8:0]	Data Strobes: SB_DQS[8:0] and its complement signal group make up a differential strobe pair. The data is captured at the crossing point of SB_DQS[8:0] and its SB_DQS#[8:0] during read and write transactions.	I/O	DDR3
SB_ECC_CB[7:0]	Data Lines for ECC Check Byte.	I/O	DDR3
SB_MA[15:0]	Memory Address: These signals are used to provide the multiplexed row and column address to the SDRAM.	O	DDR3
SB_ODT[3:0]	On-Die Termination: Active Termination Control.	O	DDR3
SB_RAS#	RAS Control Signal: This signal is used with SB_CAS# and SB_WE# (along with SB_CS#) to define the SDRAM Commands.	O	DDR3
SB_WE#	Write Enable Control Signal: This signal is used with SB_RAS# and SB_CAS# (along with SB_CS#) to define the SDRAM Commands.	O	DDR3

6.2 Memory Reference and Compensation

Table 6-4. Memory Reference and Compensation

Signal Name	Description	Direction	Type
SA_DIMM_VREFDQ SB_DIMM_VREFDQ	Channel A and B Output DDR3 DIMM DQ Reference Voltage.	O	Analog
SM_RCOMP[2:0]	System Memory Impedance Compensation.	I	Analog

6.3 Reset and Miscellaneous Signals

Table 6-5. Reset and Miscellaneous Signals (Sheet 1 of 2)

Signal Name	Description	Direction	Type
CFG[17:0]	<p>Configuration signals: The CFG signals have a default value of 1 if not terminated on the board.</p> <ul style="list-style-type: none"> • CFG[1:0]: PCI Express Bifurcation Intel Core™ i7-800 and i5-700 desktop processor series: 11 = 1 x16 PCI Express 10 = 2 x8 PCI Express 01 = Reserved 00 = Reserved • CFG[2]: Reserved configuration land. A test point may be placed on the board for this land. • CFG[3]: Reserved configuration land. • CFG[6:4]: Reserved configuration lands. A test point may be placed on the board for this land. • CFG[17:7]: Reserved configuration lands. Intel does not recommend a test point on the board for this land. 	I	CMOS
COMP0	Impedance compensation must be terminated on the system board using a precision resistor. Refer to Table 7-9 for the termination requirement.	I	Analog
COMP1	Impedance compensation must be terminated on the system board using a precision resistor. Refer to Table 7-9 for the termination requirement.	I	Analog
COMP2	Impedance compensation must be terminated on the system board using a precision resistor. Refer to Table 7-9 for the termination requirement.	I	Analog
COMP3	Impedance compensation must be terminated on the system board using a precision resistor. Refer to Table 7-9 for the termination requirement.	I	Analog
FC_x	Future Compatibility (FC) signals are signals that are available for compatibility with other processors. A test point may be placed on the board for these lands.		
PM_EXT_TS#[1:0]	External Thermal Sensor Input: If the system temperature reaches a dangerously high value, this signal can be used to trigger the start of system memory throttling.	I	CMOS
PM_SYNC	Power Management Sync: A sideband signal to communicate power management status from the platform to the processor.	I	CMOS
RESET_OBS#	This signal is an indication of the processor being reset.	O	Asynch CMOS



Table 6-5. Reset and Miscellaneous Signals (Sheet 2 of 2)

Signal Name	Description	Direction	Type
RSTIN#	Reset In: When asserted, this signal will asynchronously reset the processor logic. This signal is connected to the PLTRST# output of the PCH.	I	CMOS
RSVD	RESERVED. Must be left unconnected on the board. Intel does not recommend a test point on the board for this land.		
RSVD_NCTF	RESERVED/Non-Critical to Function: Pin for package mechanical reliability. A test point may be placed on the board for this land.		
RSVD_TP	RESERVED-Test Point. A test point may be placed on the board for this land.		
SM_DRAMRST#	DDR3 DRAM Reset: Reset signal from processor to DRAM devices. One common to all channels.	O	DDR3

6.4 PCI Express* Based Interface Signals

Table 6-6. PCI Express* Based Interface Signals

Signal Name	Description	Direction	Type
PEG_ICOMPI	PCI Express Current Compensation.	I	Analog
PEG_ICOMPO	PCI Express Current Compensation.	I	Analog
PEG_RBIAAS	PCI Express Resistor Bias Control.	I	Analog
PEG_RCOMPO	PCI Express Resistance Compensation.	I	Analog
PEG_RX[15:0] PEG_RX#[15:0]	PCI Express Receive Differential Pair.	I	PCI Express
PEG_TX[15:0] PEG_TX#[15:0]	PCI Express Transmit Differential Pair.	O	PCI Express

6.5 DMI—Processor to PCH Serial Interface

Table 6-7. DMI—Processor to PCH Serial Interface

Signal Name	Description	Direction	Type
DMI_RX[3:0] DMI_RX#[3:0]	DMI input from PCH: Direct Media Interface receive differential pair.	I	DMI
DMI_TX[3:0] DMI_TX#[3:0]	DMI output to PCH: Direct Media Interface transmit differential pair.	O	DMI



6.6 PLL Signals

Table 6-8. PLL Signals

Signal Name	Description	Direction	Type
BCLK[0] BCLK#[0]	Differential bus clock input to the processor.	I	Diff Clk
BCLK[1] BCLK#[1]	Differential bus clock input to the processor. Reserved for possible future use.	I	Diff Clk
BCLK_ITP BCLK_ITP#	Buffered differential bus clock pair to ITP.	O	Diff Clk
PEG_CLK PEG_CLK#	Differential PCI Express / DMI Clock In: These pins receive a 100-MHz Serial Reference clock. This clock is used to generate the clocks necessary for the support of PCI Express. This also is the reference clock for Intel® Flexible Display Interface.	I	Diff Clk

6.7 Intel® Flexible Display Interface Signals

Note: The signals noted below as not being used are included for reference to define all LGA 1156 land locations. These signals will be used by future processors that are compatible with LGA 1156 platforms.

Table 6-9. Intel® Flexible Display Interface

Signal Name	Description	Direction	Type
FDI_FSYNC[0]	Intel® Flexible Display Interface Frame Sync—Pipe A. Note: This signal is not used by the processor. It is connected to V _{SS} on the package.		
FDI_FSYNC[1]	Intel® Flexible Display Interface Frame Sync—Pipe B. Note: This signal is not used by the processor. It is connected to V _{SS} on the package.		
FDI_INT	Intel® Flexible Display Interface Hot Plug Interrupt. Note: This signal is not used by the processor. It is connected to V _{SS} on the package.		
FDI_LSYNC[0]	Intel® Flexible Display Interface Line Sync—Pipe A. Note: This signal is not used by the processor. It is connected to V _{SS} on the package.		
FDI_LSYNC[1]	Intel® Flexible Display Interface Line Sync—Pipe B. Note: This signal is not used by the processor. It is connected to V _{SS} on the package.		
FDI_TX[3:0] FDI_TX#[3:0]	Intel® Flexible Display Interface Transmit Differential Pair—Pipe A.. Note: These signals are not used by the processor. They are connected to V _{SS} on the package.		
FDI_TX[7:4] FDI_TX#[7:4]	Intel® Flexible Display Interface Transmit Differential Pair—Pipe B. Note: These signals are not used by the processor. They are connected to V _{SS} on the package.		



6.8 JTAG/ITP Signals

Table 6-10. JTAG/ITP

Signal Name	Description	Direction	Type
BPM#[7:0]	Breakpoint and Performance Monitor Signals: Outputs from the processor that indicate the status of breakpoints and programmable counters used for monitoring processor performance.	I/O	GTL
DBR#	DBR# is used only in systems where no debug port is implemented on the system board. DBR# is used by a debug port interposer so that an in-target probe can drive system reset.	O	
PRDY#	PRDY# is a processor output used by debug tools to determine processor debug readiness.	O	Asynch GTL
PREQ#	PREQ# is used by debug tools to request debug operation of the processor.	I	Asynch GTL
TCK	TCK (Test Clock) provides the clock input for the processor Test Bus (also known as the Test Access Port).	I	TAP
TDI	TDI (Test Data In) transfers serial test data into the processor. TDI provides the serial input needed for JTAG specification support.	I	TAP
TDI_M	TDI_M (Test Data In) transfers serial test data into the processor. TDI_M provides the serial input needed for JTAG specification support.	I	TAP
TDO	TDO (Test Data Out) transfers serial test data out of the processor. TDO provides the serial output needed for JTAG specification support.	O	TAP
TDO_M	TDO_M (Test Data Out) transfers serial test data out of the processor. TDO_M provides the serial output needed for JTAG specification support.	O	TAP
TMS	TMS (Test Mode Select) is a JTAG specification support signal used by debug tools.	I	TAP
TRST#	TRST# (Test Reset) resets the Test Access Port (TAP) logic. TRST# must be driven low during power on Reset.	I	TAP



6.9 Error and Thermal Protection

Table 6-11. Error and Thermal Protection

Signal Name	Description	Direction	Type
CATERR#	<p>Catastrophic Error: This signal indicates that the system has experienced a catastrophic error and cannot continue to operate. The processor will set this for non-recoverable machine check errors or other unrecoverable internal errors. Since this is an I/O pin, external agents are allowed to assert this pin that will cause the processor to take a machine check exception.</p> <p>CATERR# is used for signaling the following types of errors:</p> <ul style="list-style-type: none"> Legacy MCERR: CATERR# is asserted for 16 BCLKs. Legacy IERR: CATERR# remains asserted until warm or cold reset. 	I/O	GTL
PECI	PECI (Platform Environment Control Interface) is the serial sideband interface to the processor and is used primarily for thermal, power, and error management.	I/O	Asynch
PROCHOT#	PROCHOT# goes active when the processor temperature monitoring sensor(s) detects that the processor has reached its maximum safe operating temperature. This indicates that the processor Thermal Control Circuit has been activated, if enabled. This signal can also be driven to the processor to activate the Thermal Control Circuit. This signal does not have on-die termination and must be terminated on the system board.	I/O	Asynch GTL
PSI#	Processor Power Status Indicator: This signal is asserted when maximum possible processor core current consumption is less than 15 A. Assertion of this signal is an indication that the VR controller does not currently need to be able to provide I _{CC} above 15 A, and the VR controller can use this information to move to more efficient operating point. This signal will de-assert at least 3.3 μs before the current consumption will exceed 15 A. The minimum PSI# assertion and de-assertion time is 1 BCLK.	O	Asynch CMOS
THERMTRIP#	Thermal Trip: The processor protects itself from catastrophic overheating by use of an internal thermal sensor. This sensor is set well above the normal operating temperature to ensure that there are no false trips. The processor will stop all execution when the junction temperature exceeds approximately 125 °C. This is signaled to the system by the THERMTRIP# pin.	O	Asynch GTL



6.10 Power Sequencing

Table 6-12. Power Sequencing

Signal Name	Description	Direction	Type
SKTOCC#	SKTOCC# (Socket Occupied): This signal will be pulled to ground on the processor package. There is no connection to the processor silicon for this signal. System board designers may use this signal to determine if the processor is present.	O	
SM_DRAMPWROK	SM_DRAMPWROK processor input: This signal connects to PCH DRAMPWROK.	I	Asynch CMOS
TAPPWRGOOD	Power good for ITP. Indicates to the ITP when the TAP can be accessed.	O	Asynch CMOS
VCCPWRGOOD_0 VCCPWRGOOD_1	VCCPWRGOOD_0 and VCCPWRGOOD_1 (Power Good) Processor Input: The processor requires these signals to be a clean indication that V_{CC} , V_{CCPLL} , V_{TT} , V_{AXG}^1 supplies are stable and within their specifications and that BCLK is stable and has been running for a minimum number of cycles. These signals must then transition monotonically to a high state. These signals can be driven inactive at any time, but BCLK and power must again be stable before a subsequent rising edge of VCCPWRGOOD_0 and VCCPWRGOOD_1. These signals should be tied together and connected to the CPUPWRGD output signal of the PCH. Note 1: These signals are not used by the processor. They are no connect on the package.	I	Asynch CMOS
VVTPWRGOOD	The processor requires this input signal to be a clean indication that the V_{TT} power supply is stable and within specifications. 'Clean' implies that the signal will remain low (capable of sinking leakage current), without glitches, from the time that the power supplies are turned on until they come within specification. The signal must then transition monotonically to a high state. Note that it is not valid for VVTPWRGOOD to be de-asserted while VCCPWRGOOD_0 and VCCPWRGOOD_1 are asserted.	I	Asynch CMOS

6.11 Processor Core Power Signals

Table 6-13. Processor Core Power Signals (Sheet 1 of 2)

Signal Name	Description	Direction	Type
ISENSE	Current sense from VRD11.1 Compliant Regulator to the processor core.	I	Analog
VCC	Processor core power supply. The voltage supplied to these pins is determined by the VID pins.		PWR
VCC_NCTF	VCC/Non-Critical to Function: Pin for package mechanical reliability.		PWR
VCC_SENSE	VCC_SENSE and VSS_SENSE provide an isolated, low impedance connection to the processor core voltage and ground. They can be used to sense or measure voltage near the silicon.		Analog



Table 6-13. Processor Core Power Signals (Sheet 2 of 2)

Signal Name	Description	Direction	Type
VID[7:6] VID[5:3]/CSC[2:0] VID[2:0]/MSID[2:0]	<p>VID[7:0] (Voltage ID) are used to support automatic selection of power supply voltages (V_{CC}). Refer to the Voltage Regulator-Down (VRD) 11.1 Design Guidelines for more information. The voltage supply for these signals must be valid before the VR can supply V_{CC} to the processor. Conversely, the VR output must be disabled until the voltage supply for the VID signals become valid. The VR must supply the voltage that is requested by the signals, or disable itself.</p> <p>VID7 and VID6 should be tied separately to V_{SS} using a 1 kΩ resistor (This value is latched on the rising edge of VTTTPWRGOOD).</p> <p>CSC[2:0]—Current Sense Configuration bits, for ISENSE gain setting. See Voltage Regulator-Down (VRD) 11.1 Design Guidelines for gain setting information. This value is latched on the rising edge of VTTTPWRGOOD.</p> <p>MSID[2:0] (Market Segment Identification) are used to indicate the maximum platform capability to the processor. A processor will only boot if the MSID[2:0] pins are strapped to the appropriate setting (or higher) on the platform (see Table 7-3 for MSID encodings). MSID is used to help protect the platform by preventing a higher power processor from booting in a platform designed for lower power processors. MSID[2:0] are latched on the rising edge of VTTTPWRGOOD.</p>	I/O	CMOS
VSS_SENSE	VCC_SENSE and VSS_SENSE provide an isolated, low impedance connection to the processor core voltage and ground. They can be used to sense or measure voltage near the silicon.		Analog
VSS_SENSE_VTT	VTT_SENSE and VSS_SENSE_VTT provide an isolated, low impedance connection to the processor V_{TT} voltage and ground. They can be used to sense or measure voltage near the silicon.		Analog
VTT	Processor power for the memory controller, shared cache and I/O (1.1 V).		PWR
VTT_SELECT	The VTT_SELECT signal is used to select the correct V_{TT} voltage level for the processor. The processor will be configured to drive a low voltage level for VTT_SELECT.	O	CMOS
VTT_SENSE	VTT_SENSE and VSS_SENSE_VTT provide an isolated, low impedance connection to the processor V_{TT} voltage and ground. They can be used to sense or measure voltage near the silicon.		Analog



6.12 Graphics and Memory Core Power Signals

Note: The signals noted below as not being used are included for reference to define all LGA 1156 land locations. These signals will be used by future processors that are compatible with LGA 1156 platforms.

Table 6-14. Graphics and Memory Power Signals

Signal Name	Description	Direction	Type
GFX DPRSLPVR	Integrated graphics output signal to a VRD11.1 compliant VR. When asserted this signal indicates that the integrated graphics is in render suspend mode. This signal is also used to control render suspend state exit slew rate. Note: This signal is not used by the processor. It is connected to V _{SS} on the package.		
GFX_IMON	Current Sense from an VRD11.1 compliant VR to the integrated graphics. Note: This signal is not used by the processor. It is connected to V _{SS} on the package.		
GFX VID[6:0]	GFX VID[6:0] (Voltage ID) pins are used to support automatic selection of nominal voltages (V _{AXG}). These are CMOS signals that are driven by the processor. The VID code output by VID[6:0] and associated voltages are given in Chapter 7 . Note: These signals are not used by the processor. They are connected to V _{TT} on the package.		
GFX_VR_EN	Integrated graphics output signal to integrated graphics VR. This signal is used as an on/off control to enable/disable the integrated graphics VR. Note: This signal is not used by the processor. It is connected to V _{SS} on the package.		
VAXG	Graphics core power supply. Note: These signals are not used by the processor. They are no connect on the package.		
VAXG_SENSE	VAXG_SENSE and VSSAXG_SENSE provide an isolated, low impedance connection to the VAXG voltage and ground. They can be used to sense or measure voltage near the silicon. Note: This signal is not used by the processor. It is a no connect on the package.		
VCCPLL	VCCPLL provides isolated power for internal processor PLLs.		PWR
VDDQ	Processor I/O supply voltage for DDR3.		PWR
VSSAXG_SENSE	VAXG_SENSE and VSSAXG_SENSE provide an isolated, low impedance connection to the VAXG voltage and ground. They can be used to sense or measure voltage near the silicon. Note: This signal is not used by the processor. It is connected to V _{SS} on the package.		



6.13 Ground and NCTF

Table 6-15. Ground and NCTF

Signal Name	Description	Direction	Type
VSS	VSS are the ground pins for the processor and should be connected to the system ground plane.		GND
CGC_TP_NCTF	Corner Ground Connection: This land may be used to test for connection to ground. A test point may be placed on the board for this land. This land is considered Non-Critical to Function.		

6.14 Processor Internal Pull Up/Pull Down

Table 6-16. Processor Internal Pull Up/Pull Down

Signal Name	Pull Up/Pull Down	Rail	Value
SM_DRAMPWROK	Pull Down	VSS	10–20 kΩ
VCCPWRGOOD_0 VCCPWRGOOD_1	Pull Down	VSS	10–20 kΩ
VTPWRGOOD	Pull Down	VSS	10–20 kΩ
BPM#[7:0]	Pull Up	VTT	44–55 Ω
TCK	Pull Up	VTT	44–55 Ω
TDI	Pull Up	VTT	44–55 Ω
TMS	Pull Up	VTT	44–55 Ω
TRST#	Pull Up	VTT	1–5 kΩ
TDI_M	Pull Up	VTT	44–55 Ω
PREQ#	Pull Up	VTT	44–55 Ω
CFG[17:0]	Pull Up	VTT	5–14 kΩ

§ §



7 Electrical Specifications

7.1 Power and Ground Lands

The processor has VCC, VTT, VDDQ, VCCPLL, VAXG¹, and VSS (ground) inputs for on-chip power distribution. All power lands must be connected to their respective processor power planes, while all VSS lands must be connected to the system ground plane. Use of multiple power and ground planes is recommended to reduce I*R drop. The VCC lands must be supplied with the voltage determined by the processor Voltage Identification (VID) signals. [Table 7-1](#) specifies the voltage level for the various VIDs.

7.2 Decoupling Guidelines

Due to its large number of transistors and high internal clock speeds, the processor is capable of generating large current swings between low- and full-power states. This may cause voltages on power planes to sag below their minimum values, if bulk decoupling is not adequate. Larger bulk storage (C_{BULK}), such as electrolytic capacitors, supply current during longer lasting changes in current demand (for example, coming out of an idle condition). Similarly, capacitors act as a storage well for current when entering an idle condition from a running condition. To keep voltages within specification, output decoupling must be properly designed.

Caution: Design the board to ensure that the voltage provided to the processor remains within the specifications listed in [Table 7-5](#). Failure to do so can result in timing violations or reduced lifetime of the processor. For further information and design guidelines, refer to the *Voltage Regulator Down (VRD) 11.1 Design Guidelines*.

7.2.1 Voltage Rail Decoupling

The voltage regulator solution needs to provide:

- bulk capacitance with low effective series resistance (ESR).
- a low interconnect resistance from the regulator to the socket.
- bulk decoupling to compensate for large current swings generated during power-on, or low-power idle state entry/exit.

The power delivery solution must ensure that the voltage and current specifications are met, as defined in [Table 7-5](#).

1. These signals are not used by the processor. They are no connect on the package.



7.3 Processor Clocking (BCLK[0], BCLK#[0])

The processor uses a differential clock to generate the processor core(s) operating frequency, memory controller frequency, and other internal clocks. The processor core frequency is determined by multiplying the processor core ratio by 133 MHz. Clock multiplying within the processor is provided by an internal phase locked loop (PLL) that requires a constant frequency input, with exceptions for Spread Spectrum Clocking (SSC).

The processor maximum core frequency is configured during power-on reset by using its manufacturing default value. This value is the highest core multiplier at which the processor can operate. If lower maximum speeds are desired, the appropriate ratio can be configured using the FLEX_RATIO MSR.

7.3.1 PLL Power Supply

An on-die PLL filter solution is implemented on the processor. Refer to [Table 7-6](#) for DC specifications.

7.4 V_{CC} Voltage Identification (VID)

The VID specification for the processor is defined by the *Voltage Regulator Down (VRD) 11.1 Design Guidelines*. The processor uses eight voltage identification signals, VID[7:0], to support automatic selection of voltages. [Table 7-1](#) specifies the voltage level corresponding to the state of VID[7:0]. A '1' in this table refers to a high voltage level and a '0' refers to a low voltage level. If the processor socket is empty (VID[7:0] = 11111111), or the voltage regulation circuit cannot supply the voltage that is requested, the voltage regulator must disable itself. See the *Voltage Regulator Down (VRD) 11.1 Design Guidelines* for further details. VID signals are CMOS push/pull drivers. Refer to [Table 7-9](#) for the DC specifications for these signals. The VID codes will change due to temperature and/or current load changes to minimize the power of the part. A voltage range is provided in [Table 7-5](#). The specifications are set so that one voltage regulator can operate with all supported frequencies.

Individual processor VID values may be set during manufacturing so that two devices at the same core frequency may have different default VID settings. This is shown in the VID range values in [Table 7-5](#). The processor provides the ability to operate while transitioning to an adjacent VID and its associated processor core voltage (V_{CC}). This will represent a DC shift in the loadline.

Note: A low-to-high or high-to-low voltage state change will result in as many VID transitions as necessary to reach the target core voltage. Transitions above the maximum specified VID are not permitted. One VID transition occurs in 1.25 us. [Table 7-1](#) includes VID step sizes and DC shift ranges. Minimum and maximum voltages must be maintained.

The VR used must be capable of regulating its output to the value defined by the new VID values issued. DC specifications for dynamic VID transitions are included in [Table 7-5](#) and [Table 7-7](#). See the *Voltage Regulator Down (VRD) 11.1 Design Guidelines* for further details.

Several of the VID signals (VID[5:3]/CSC[2:0] and VID[2:0]/MSID[2:0]) serve a dual purpose and are sampled during reset. Refer to the signal description table in [Chapter 6](#) and [Table 7-3](#) for further information.

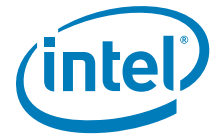

Table 7-1. VRD 11.1/11.0 Voltage Identification Definition (Sheet 1 of 3)

VID 7	VID 6	VID 5	VID 4	VID 3	VID 2	VID 1	VID 0	V _{CC_MAX}
0	0	0	0	0	0	0	0	OFF
0	0	0	0	0	0	0	1	OFF
0	0	0	0	0	0	1	0	1.60000
0	0	0	0	0	0	1	1	1.59375
0	0	0	0	0	1	0	0	1.58750
0	0	0	0	0	1	0	1	1.58125
0	0	0	0	0	1	1	0	1.57500
0	0	0	0	0	1	1	1	1.56875
0	0	0	0	1	0	0	0	1.56250
0	0	0	0	1	0	0	1	1.55625
0	0	0	0	1	0	1	0	1.55000
0	0	0	0	1	0	1	1	1.54375
0	0	0	0	1	1	0	0	1.53750
0	0	0	0	1	1	0	1	1.53125
0	0	0	0	1	1	1	0	1.52500
0	0	0	0	1	1	1	1	1.51875
0	0	0	1	0	0	0	0	1.51250
0	0	0	1	0	0	0	1	1.50625
0	0	0	1	0	0	1	0	1.50000
0	0	0	1	0	0	1	1	1.49375
0	0	0	1	0	1	0	0	1.48750
0	0	0	1	0	1	0	1	1.48125
0	0	0	1	0	1	1	0	1.47500
0	0	0	1	0	1	1	1	1.46875
0	0	0	1	1	0	0	0	1.46250
0	0	0	1	1	0	0	1	1.45625
0	0	0	1	1	0	1	0	1.45000
0	0	0	1	1	0	1	1	1.44375
0	0	0	1	1	1	0	0	1.43750
0	0	0	1	1	1	0	1	1.43125
0	0	0	1	1	1	1	0	1.42500
0	0	0	1	1	1	1	1	1.41875
0	0	1	0	0	0	0	0	1.41250
0	0	1	0	0	0	0	1	1.40625
0	0	1	0	0	0	1	0	1.40000
0	0	1	0	0	0	1	1	1.39375
0	0	1	0	0	1	0	0	1.38750
0	0	1	0	0	1	0	1	1.38125
0	0	1	0	0	1	1	0	1.37500

VID 7	VID 6	VID 5	VID 4	VID 3	VID 2	VID 1	VID 0	V _{CC_MAX}
0	1	0	1	1	0	1	1	1.04375
0	1	0	1	1	1	0	0	1.03750
0	1	0	1	1	1	0	1	1.03125
0	1	0	1	1	1	1	0	1.02500
0	1	0	1	1	1	1	1	1.01875
0	1	1	0	0	0	0	0	1.01250
0	1	1	0	0	0	0	1	1.00625
0	1	1	0	0	0	1	0	1.00000
0	1	1	0	0	0	1	1	0.99375
0	1	1	0	0	1	0	0	0.98750
0	1	1	0	0	1	0	1	0.98125
0	1	1	0	0	1	1	0	0.97500
0	1	1	0	0	1	1	1	0.96875
0	1	1	0	1	0	0	0	0.96250
0	1	1	0	1	0	0	1	0.95626
0	1	1	0	1	0	1	0	0.95000
0	1	1	0	1	0	1	1	0.94375
0	1	1	0	1	1	0	0	0.93750
0	1	1	0	1	1	0	1	0.93125
0	1	1	0	1	1	1	0	0.92500
0	1	1	0	1	1	1	1	0.91875
0	1	1	1	0	0	0	0	0.91250
0	1	1	1	0	0	0	1	0.90625
0	1	1	1	0	0	1	0	0.90000
0	1	1	1	0	0	1	1	0.89375
0	1	1	1	0	1	0	0	0.88750
0	1	1	1	0	1	0	1	0.88125
0	1	1	1	0	1	1	0	0.87500
0	1	1	1	0	1	1	1	0.86875
0	1	1	1	1	0	0	0	0.86250
0	1	1	1	1	0	0	1	0.85625
0	1	1	1	1	0	1	0	0.85000
0	1	1	1	1	0	1	1	0.84374
0	1	1	1	1	1	0	0	0.83750
0	1	1	1	1	1	0	1	0.83125
0	1	1	1	1	1	1	0	0.82500
0	1	1	1	1	1	1	1	0.81875
1	0	0	0	0	0	0	0	0.81250
1	0	0	0	0	0	0	1	0.80625



Table 7-1. VRD 11.1/11.0 Voltage Identification Definition (Sheet 2 of 3)

VID 7	VID 6	VID 5	VID 4	VID 3	VID 2	VID 1	VID 0	V _{CC_MAX}
0	0	1	0	0	1	1	1	1.36875
0	0	1	0	1	0	0	0	1.36250
0	0	1	0	1	0	0	1	1.35625
0	0	1	0	1	0	1	0	1.35000
0	0	1	0	1	0	1	1	1.34375
0	0	1	0	1	1	0	0	1.33750
0	0	1	0	1	1	0	1	1.33125
0	0	1	0	1	1	1	0	1.32500
0	0	1	0	1	1	1	1	1.31875
0	0	1	1	0	0	0	0	1.31250
0	0	1	1	0	0	0	1	1.30625
0	0	1	1	0	0	1	0	1.30000
0	0	1	1	0	0	1	1	1.29375
0	0	1	1	0	1	0	0	1.28750
0	0	1	1	0	1	0	1	1.28125
0	0	1	1	0	1	1	0	1.27500
0	0	1	1	0	1	1	1	1.26875
0	0	1	1	1	0	0	0	1.26250
0	0	1	1	1	0	0	1	1.25625
0	0	1	1	1	0	1	0	1.25000
0	0	1	1	1	0	1	1	1.24375
0	0	1	1	1	1	0	0	1.23750
0	0	1	1	1	1	0	1	1.23125
0	0	1	1	1	1	1	0	1.22500
0	0	1	1	1	1	1	1	1.21875
0	1	0	0	0	0	0	0	1.21250
0	1	0	0	0	0	0	1	1.20625
0	1	0	0	0	0	1	0	1.20000
0	1	0	0	0	0	1	1	1.19375
0	1	0	0	0	1	0	0	1.18750
0	1	0	0	0	1	0	1	1.18125
0	1	0	0	0	1	1	0	1.17500
0	1	0	0	0	1	1	1	1.16875
0	1	0	0	1	0	0	0	1.16250
0	1	0	0	1	0	0	1	1.15625
0	1	0	0	1	0	1	0	1.15000
0	1	0	0	1	0	1	1	1.14375
0	1	0	0	1	1	0	0	1.13750
0	1	0	0	1	1	0	1	1.13125
0	1	0	0	1	1	1	0	1.12500

VID 7	VID 6	VID 5	VID 4	VID 3	VID 2	VID 1	VID 0	V _{CC_MAX}
1	0	0	0	0	0	1	0	0.80000
1	0	0	0	0	0	1	1	0.79375
1	0	0	0	0	1	0	0	0.78750
1	0	0	0	0	1	0	1	0.78125
1	0	0	0	0	1	1	0	0.77500
1	0	0	0	0	1	1	1	0.76875
1	0	0	0	1	0	0	0	0.76250
1	0	0	0	1	0	0	1	0.75625
1	0	0	0	1	0	1	0	0.75000
1	0	0	0	1	0	1	1	0.74375
1	0	0	0	1	1	0	0	0.73750
1	0	0	0	1	1	0	1	0.73125
1	0	0	0	1	1	1	0	0.72500
1	0	0	0	1	1	1	1	0.71875
1	0	0	1	0	0	0	0	0.71250
1	0	0	1	0	0	0	1	0.70625
1	0	0	1	0	0	1	0	0.70000
1	0	0	1	0	0	1	1	0.69375
1	0	0	1	0	1	0	0	0.68750
1	0	0	1	0	1	0	1	0.68125
1	0	0	1	0	1	1	0	0.67500
1	0	0	1	0	1	1	1	0.66875
1	0	0	1	1	0	0	0	0.66250
1	0	0	1	1	0	0	1	0.65625
1	0	0	1	1	0	1	0	0.65000
1	0	0	1	1	0	1	1	0.64375
1	0	0	1	1	1	0	0	0.63750
1	0	0	1	1	1	0	1	0.63125
1	0	0	1	1	1	1	0	0.62500
1	0	0	1	1	1	1	1	0.61875
1	0	1	0	0	0	0	0	0.61250
1	0	1	0	0	0	0	1	0.60625
1	0	1	0	0	0	1	0	0.60000
1	0	1	0	0	0	1	1	0.59375
1	0	1	0	0	1	0	0	0.58750
1	0	1	0	0	1	0	1	0.58125
1	0	1	0	0	1	1	0	0.57500
1	0	1	0	0	1	1	1	0.56875
1	0	1	0	1	0	0	0	0.56250
1	0	1	0	1	0	0	1	0.55625



Table 7-1. VRD 11.1/11.0 Voltage Identification Definition (Sheet 3 of 3)

VID 7	VID 6	VID 5	VID 4	VID 3	VID 2	VID 1	VID 0	V _{CC_MAX}	VID 7	VID 6	VID 5	VID 4	VID 3	VID 2	VID 1	VID 0	V _{CC_MAX}
0	1	0	0	1	1	1	1	1.11875	1	0	1	0	1	0	1	0	0.55000
0	1	0	1	0	0	0	0	1.11250	1	0	1	0	1	0	1	1	0.54375
0	1	0	1	0	0	0	1	1.10625	1	0	1	0	1	1	0	0	0.53750
0	1	0	1	0	0	1	0	1.10000	1	0	1	0	1	1	0	1	0.53125
0	1	0	1	0	0	1	1	1.09375	1	0	1	0	1	1	1	0	0.52500
0	1	0	1	0	1	0	0	1.08750	1	0	1	0	1	1	1	1	0.51875
0	1	0	1	0	1	0	1	1.08125	1	0	1	1	0	0	0	0	0.51250
0	1	0	1	0	1	1	0	1.07500	1	0	1	1	0	0	0	1	0.50625
0	1	0	1	0	1	1	1	1.06875	1	0	1	1	0	0	1	0	0.50000
0	1	0	1	1	0	0	0	1.06250	1	1	1	1	1	1	1	0	OFF
0	1	0	1	1	0	0	1	1.05625	1	1	1	1	1	1	1	1	OFF
0	1	0	1	1	0	1	0	1.05000									

Table 7-2. Market Segment Selection Truth Table for MSID[2:0]

MSID2	MSID1	MSID0	Description ¹
0	0	0	Reserved
0	0	1	Reserved
0	1	0	Reserved
0	1	1	Reserved
1	0	0	Reserved
1	0	1	2009A processors supported ²
1	1	0	2009B processors supported ³
1	1	1	Reserved

Notes:

1. The MSID[2:0] signals are provided to indicate the maximum platform capability to the processor.
2. 2009A processors have thermal requirements that are equivalent to those of the Intel® Core™2 Duo E8000 processor series. Refer to the appropriate processor Thermal and Mechanical Specifications and Design Guidelines for additional information (see [Section 1.7](#)).
3. 2009B processors have thermal requirements that are equivalent to those of the Intel® Core™2 Quad Q9000 processor series. Refer to the appropriate processor Thermal and Mechanical Specifications and Design Guidelines for additional information (see [Section 1.7](#)).



7.5 Reserved or Unused Signals

The following are the general types of reserved (RSVD) signals and connection guidelines:

- RSVD – these signals should not be connected
- RSVD_TP – these signals should be routed to a test point
- RSVD_NCTF – these signals are non-critical to function and may be left unconnected

Arbitrary connection of these signals to V_{CC} , V_{TT} , V_{DDQ} , V_{CCPLL} , V_{SS} , or to any other signal (including each other) may result in component malfunction or incompatibility with future processors. See [Chapter 8](#) for a land listing of the processor and the location of all reserved signals.

For reliable operation, always connect unused inputs or bi-directional signals to an appropriate signal level. Unused active high inputs should be connected through a resistor to ground (V_{SS}). Unused outputs may be left unconnected; however, this may interfere with some Test Access Port (TAP) functions, complicate debug probing, and prevent boundary scan testing. A resistor must be used when tying bi-directional signals to power or ground. When tying any signal to power or ground, a resistor will also allow for system testability. For details, see [Table 7-9](#).

7.6 Signal Groups

Signals are grouped by buffer type and similar characteristics as listed in [Table 7-3](#). The buffer type indicates which signaling technology and specifications apply to the signals. All the differential signals, and selected DDR3 and Control Sideband signals, have On-Die Termination (ODT) resistors. There are some signals that do not have ODT and need to be terminated on the board.

Table 7-3. Signal Groups (Sheet 1 of 2)¹

Signal Group	Alpha Group	Type	Signals
System Reference Clock			
Differential	(a)	CMOS Input	BCLK[0], BCLK#[0], BCLK[1], BCLK#[1], PEG_CLK, PEG_CLK#
Differential	(b)	CMOS Output	BCLK_ITP, BCLK_ITP#
DDR3 Reference Clocks²			
Differential	(c)	DDR3 Output	SA_CK[3:0], SA_CK#[3:0] SB_CK[3:0], SB_CK#[3:0]
DDR3 Command Signals²			
Single Ended	(d)	DDR3 Output	SA_RAS#, SB_RAS#, SA_CAS#, SB_CAS# SA_WE#, SB_WE# SA_MA[15:0], SB_MA[15:0] SA_BS[2:0], SB_BS[2:0] SA_DM[7:0] ⁴ , SB_DM[7:0] ⁴ SM_DRAMRST# SA_CS#[3:0], SB_CS#[3:0] SA_CS#[7:4], SB_CS#[7:4] SA_ODT[3:0], SB_ODT[3:0] SA_CKE[3:0], SB_CKE[3:0]
DDR3 Data Signals²			
Single ended	(e)	DDR3 Bi-directional	SA_DQ[63:0], SB_DQ[63:0]
Differential	(f)	DDR3 Bi-directional	SA_DQS[8:0], SA_DQS#[8:0] SA_ECC_CB[7:0] ³ SB_DQS[8:0], SB_DQS#[8:0] SB_ECC_CB[7:0] ³
TAP (ITP/XDP)			
Single Ended	(g)	CMOS Input	TCK, TDI, TMS, TRST#, TDI_M
Single Ended	(h)	CMOS Open-Drain Output	TDO, TDO_M
Single Ended	(i)	Asynchronous CMOS Output	TAPPWRGOOD
Control Sideband			
Single Ended	(ja)	Asynchronous CMOS Input	VCCPWRGOOD_0, VCCPWRGOOD_1, VTPPWRGOOD
Single Ended	(jb)	Asynchronous CMOS Input	SM_DRAMPWROK
Single Ended	(k)	Asynchronous Output	RESET_OBS#
Single Ended	(l)	Asynchronous GTL Output	PRDY#, THERMTRIP#
Single Ended	(m)	Asynchronous GTL Input	PREQ#
Single Ended	(n)	GTL Bi-directional	CATERR#, BPM#[7:0]
Single Ended	(o)	Asynchronous Bi-directional	PECI
Single Ended	(p)	Asynchronous GTL Bi-directional	PROCHOT#
Single Ended	(qa)	CMOS Input	CFG[17:0], PM_SYNC, PM_EXT_TS#[1:0]



Table 7-3. Signal Groups (Sheet 2 of 2)¹

Signal Group	Alpha Group	Type	Signals
Single Ended	(qb)	CMOS Input	RSTIN#
Single Ended	(r)	CMOS Output	VTT_SELECT
Single Ended	(s)	CMOS Bi-directional	VID[7:6] VID[5:3]/CSC[2:0] VID[2:0]/MSID[2:0]
Single Ended	(t)	Analog Input	COMP0, COMP1, COMP2, COMP3, SM_RCOMP[2:0], ISENSE
Single Ended	(ta)	Analog Output	SA_DIMM_VREFDQ SB_DIMM_VREFDQ
Power/Ground/Other			
	(u)	Power	VCC, VCC_NCTF, VTT, VCCPLL, VDDQ, VAXG ⁵
	(v)	Ground	VSS, CGC_TP_NCTF
	(w)	No Connect	RSVD, RSVD_NCTF, RSVD_TP, FC_x
Single Ended	(x)	Asynchronous CMOS Output	PSI#
	(y)	Sense Points	VCC_SENSE, VSS_SENSE, VTT_SENSE, VSS_SENSE_VTT, VAXG_SENSE ⁵ , VSSAXG_SENSE ⁵
	(z)	Other	SKTOCC#, DBR#
PCI Express*			
Differential	(ac)	PCI Express Input	PEG_RX[15:0], PEG_RX#[15:0]
Differential	(ad)	PCI Express Output	PEG_TX[15:0], PEG_TX#[15:0]
Single Ended	(ae)	Analog Input	PEG_ICOMP0, PEG_ICOMPI, PEG_RCOMP0, PEG_RBIAS
DMI			
Differential	(af)	DMI Input	DMI_RX[3:0], DMI_RX#[3:0]
Differential	(ag)	DMI Output	DMI_TX[3:0], DMI_TX#[3:0]
Intel® FDI			
Single Ended	(ah)	FDI Input	FDI_FSYNC[1:0] ⁴ , FDI_LSYNC[1:0] ⁴ , FDI_INT ⁴
Differential	(ai)	FDI Output	FDI_TX[7:0] ⁴ , FDI_TX#[7:0] ⁴

Notes:

1. Refer to [Chapter 6](#) for signal description details.
2. SA and SB refer to DDR3 Channel A and DDR3 Channel B.
3. These signals are only used on processors and platforms that support ECC DIMMs.
4. These signals will not be actively used on the Intel Core™ i7-800 and i5-700 desktop processor series.
5. These signals are not used by the processor. They are no connect on the package.

All Control Sideband Asynchronous signals are required to be asserted/de-asserted for at least eight BCLKs for the processor to recognize the proper signal state. See [Section 7.9](#) for the DC specifications.



7.7 Test Access Port (TAP) Connection

Due to the voltage levels supported by other components in the Test Access Port (TAP) logic, Intel recommends the processor be first in the TAP chain, followed by any other components within the system. A translation buffer should be used to connect to the rest of the chain unless one of the other components is capable of accepting an input of the appropriate voltage. Two copies of each signal may be required with each driving a different voltage level.

7.8 Absolute Maximum and Minimum Ratings

Table 7-4 specifies absolute maximum and minimum ratings. At conditions outside functional operation condition limits, but within absolute maximum and minimum ratings, neither functionality nor long-term reliability can be expected. If a device is returned to conditions within functional operation limits after having been subjected to conditions outside these limits (but within the absolute maximum and minimum ratings) the device may be functional, but with its lifetime degraded depending on exposure to conditions exceeding the functional operation condition limits.

At conditions exceeding absolute maximum and minimum ratings, neither functionality nor long-term reliability can be expected. Moreover, if a device is subjected to these conditions for any length of time, it will either not function or its reliability will be severely degraded when returned to conditions within the functional operating condition limits.

Although the processor contains protective circuitry to resist damage from Electro-Static Discharge (ESD), precautions should always be taken to avoid high static voltages or electric fields.

Table 7-4. Processor Absolute Minimum and Maximum Ratings

Symbol	Parameter	Min	Max	Unit	Notes ^{1, 2}
V _{CC}	Processor Core voltage with respect to V _{SS}	-0.3	1.40	V	6
V _{TT}	Voltage for the memory controller and Shared Cache with respect to V _{SS}	-0.3	1.40	V	
V _{DDQ}	Processor I/O supply voltage for DDR3 with respect to V _{SS}	-0.3	1.80	V	
V _{CCPLL}	Processor PLL voltage with respect to V _{SS}	-0.3	1.98	V	
T _{STORAGE}	Storage temperature	-40	85	°C	3, 4, 5

Notes:

1. For functional operation, all processor electrical, signal quality, mechanical and thermal specifications must be satisfied.
2. Excessive overshoot or undershoot on any signal will likely result in permanent damage to the processor.
3. Storage temperature is applicable to storage conditions only. In this scenario, the processor must not receive a clock, and no lands can be connected to a voltage bias. Storage within these limits will not affect the long-term reliability of the device. For functional operation, refer to the processor case temperature specifications.
4. This rating applies to the processor and does not include any tray or packaging.
5. Failure to adhere to this specification can affect the long-term reliability of the processor.
6. V_{CC} is a VID based rail.



7.9 DC Specifications

The processor DC specifications in this section are defined at the processor pads, unless noted otherwise. See Chapter 8 for the processor land listings and Chapter 6 for signal definitions. Voltage and current specifications are detailed in Table 7-5 and Table 7-6. For platform planning, refer to Table 7-7 that provides V_{CC} static and transient tolerances. This same information is presented graphically in Figure 7-1.

The DC specifications for the DDR3 signals are listed in Table 7-8 Control Sideband and Test Access Port (TAP) are listed in Table 7-9.

Table 7-5 through Table 7-6 list the DC specifications for the processor and are valid only while meeting the thermal specifications (as specified in the processor Thermal and Mechanical Specifications and Guidelines), clock frequency, and input voltages. Care should be taken to read all notes associated with each parameter.

7.9.1 Voltage and Current Specifications

Table 7-5. Processor Core Active and Idle Mode DC Voltage and Current Specifications

Symbol	Parameter		Min	Typ	Max	Unit	Note
VID	VID Range		0.6500	—	1.4000	V	
V_{CC}	V_{CC} for processor core		See Table 7-7 and Figure 7-1			V	1, 2, 3
$V_{CC,BOOT}$	Default V_{CC} voltage for initial power up		—	1.10	—	V	
I_{CC}	Processor Number	2009B I_{CC} : for Intel Core™ i7-800 and i5-700 processor series with 95 W TDP					
	i7-880	3.06 GHz	—	—	110	A	4
	i7-875K	2.93 GHz			110		
	i7-870	2.93 GHz			110		
	i7-860	2.80 GHz			110		
	i5-760	2.80 GHz			110		
I_{CC}	Processor Number	2009A I_{CC} : for Intel Core™ i7-800 and i5-700 processor series with 82 W TDP					
	i7-870S	2.66 GHz	—	—	75	A	4
	i7-860S	2.53 GHz			75		
	i5-750S	2.40 GHz			75		
I_{CC_TDC}	2009B Sustained I_{CC} : recommended design target for Intel Core™ i7-800 and i5-700 processor series with 95 W TDP		—	—	90	A	
I_{CC_TDC}	2009A Sustained I_{CC} : recommended design target for Intel Core™ i7-800 and i5-700 processor series with 82 W TDP		—	—	60	A	

Notes:

- Each processor is programmed with a maximum valid voltage identification value (VID) that is set at manufacturing and cannot be altered. Individual maximum VID values are calibrated during manufacturing such that two processors at the same frequency may have different settings within the VID range. Note that this differs from the VID employed by the processor during a power management event (Adaptive Thermal Monitor, Enhanced Intel SpeedStep Technology, or Low Power States).
- The voltage specification requirements are measured across V_{CC_SENSE} and V_{SS_SENSE} lands at the socket with a 100-MHz bandwidth oscilloscope, 1.5 pF maximum probe capacitance, and 1-M Ω minimum impedance. The maximum length of ground wire on the probe should be less than 5 mm. Ensure external noise from the system is not coupled into the oscilloscope probe.
- Refer to Table 7-7 and Figure 7-1 for the minimum, typical, and maximum V_{CC} allowed for a given current. The processor should not be subjected to any V_{CC} and I_{CC} combination wherein V_{CC} exceeds V_{CC_MAX} for a given current.
- I_{CC_MAX} specification is based on the V_{CC_MAX} loadline. Refer to Figure 7-1 for details.



Table 7-6. Processor Uncore I/O Buffer Supply DC Voltage and Current Specifications

Symbol	Parameter	Min	Typ	Max	Unit	Note
V_{TT}	Voltage for the memory controller and shared cache defined at the socket motherboard VTT pinfield via.	1.045	1.10	1.155	V	1
	Voltage for the memory controller and shared cache defined across VTT_SENSE and VSS_SENSE_VTT.	1.023	1.10	1.117	V	2
V_{DDQ}	Processor I/O supply voltage for DDR3	1.425	1.5	1.575	V	
V_{CCPLL}	PLL supply voltage (DC + AC specification)	1.71	1.8	1.89	V	
I_{TT}	2009B (Intel Core™ i7-800 and i5-700 series processor with 95 W TDP): Current for the memory controller and Shared Cache	—	—	35	A	
I_{TT}	2009A (Intel Core™ i7-800 and i5-700 series processor with 82 W TDP): Current for the memory controller and Shared Cache	—	—	35	A	
I_{TT_TDC}	2009B (Intel Core™ i7-800 and i5-700 series processor with 95 W TDP): Sustained current for the memory controller and Shared Cache	—	—	30	A	
I_{TT_TDC}	2009A (Intel Core™ i7-800 and i5-700 series processor with 82 W TDP): Sustained current for the memory controller and Shared Cache	—	—	30	A	
I_{DDQ}	Processor I/O supply current for DDR3	—	—	6	A	
I_{DDQ_TDC}	Processor I/O supply sustained current for DDR3	—	—	6	A	
$I_{DDQ_STANDBY}$	Processor I/O supply standby current for DDR3	—	—	0.650	A	
I_{CC_VCCPLL}	PLL supply current	—	—	1.1	A	
$I_{CC_VCCPLL_TDC}$	PLL sustained supply current	—	—	0.7	A	

Notes:

- V_{TT} must be provided using a separate voltage source and not be connected to V_{CC} . The voltage specification requirements are defined in the middle of the VTT pinfield at the processor socket vias on the bottom side of the baseboard. The voltage specifications are measured with a 20-MHz bandwidth oscilloscope, 1.5 pF maximum probe capacitance, and 1 M Ω minimum impedance. The maximum length of ground wire on the probe should be less than 5 mm. Ensure external noise from the system is not coupled into the oscilloscope probe.
- V_{TT} must be provided using a separate voltage source and not be connected to V_{CC} . The voltage specification requirements are defined across VTT_SENSE and VSS_SENSE_VTT lands at the processor socket vias on the bottom side of the baseboard. The requirements across the SENSE signals account for voltage drops and impedances across the baseboard vias, socket, and processor package up to the processor Si. The voltage specifications are measured with a 20-MHz bandwidth oscilloscope, 1.5 pF maximum probe capacitance, and 1 M Ω minimum impedance. The maximum length of ground wire on the probe should be less than 5 mm. Ensure external noise from the system is not coupled into the oscilloscope probe.



Table 7-7. V_{CC} Static and Transient Tolerance

I _{CC} (A)	Voltage Deviation from VID Setting ^{1, 2, 3}		
	V _{CC_Max} (V) 1.40 mΩ	V _{CC_Typ} (V) 1.40 mΩ	V _{CC_Min} (V) 1.40 mΩ
0	0.000	-0.019	-0.038
5	-0.007	-0.026	-0.045
10	-0.014	-0.033	-0.052
15	-0.021	-0.040	-0.059
20	-0.028	-0.047	-0.066
25	-0.035	-0.054	-0.073
30	-0.042	-0.061	-0.080
35	-0.049	-0.068	-0.087
40	-0.056	-0.075	-0.094
45	-0.063	-0.082	-0.101
50	-0.070	-0.089	-0.108
55	-0.077	-0.096	-0.115
60	-0.084	-0.103	-0.122
65	-0.091	-0.110	-0.129
70	-0.098	-0.117	-0.136
75	-0.105	-0.124	-0.143
80	-0.112	-0.131	-0.150
85	-0.119	-0.138	-0.157
90	-0.126	-0.145	-0.164
95	-0.133	-0.152	-0.171
100	-0.140	-0.159	-0.178
110	-0.147	-0.166	-0.185

Notes:

1. The V_{CC_Min} and V_{CC_Max} loadlines represent static and transient limits.
2. This table is intended to aid in reading discrete points on [Figure 7-1](#).
3. The loadlines specify voltage limits at the die measured at the VCC_SENSE and VSS_SENSE lands. Voltage regulation feedback for voltage regulator circuits must also be taken from processor VCC_SENSE and VSS_SENSE lands. Refer to the *Voltage Regulator Down (VRD) 11.1 Design Guidelines* for socket load line guidelines and VR implementation.



Figure 7-1. V_{CC} Static and Transient Tolerance Loadlines

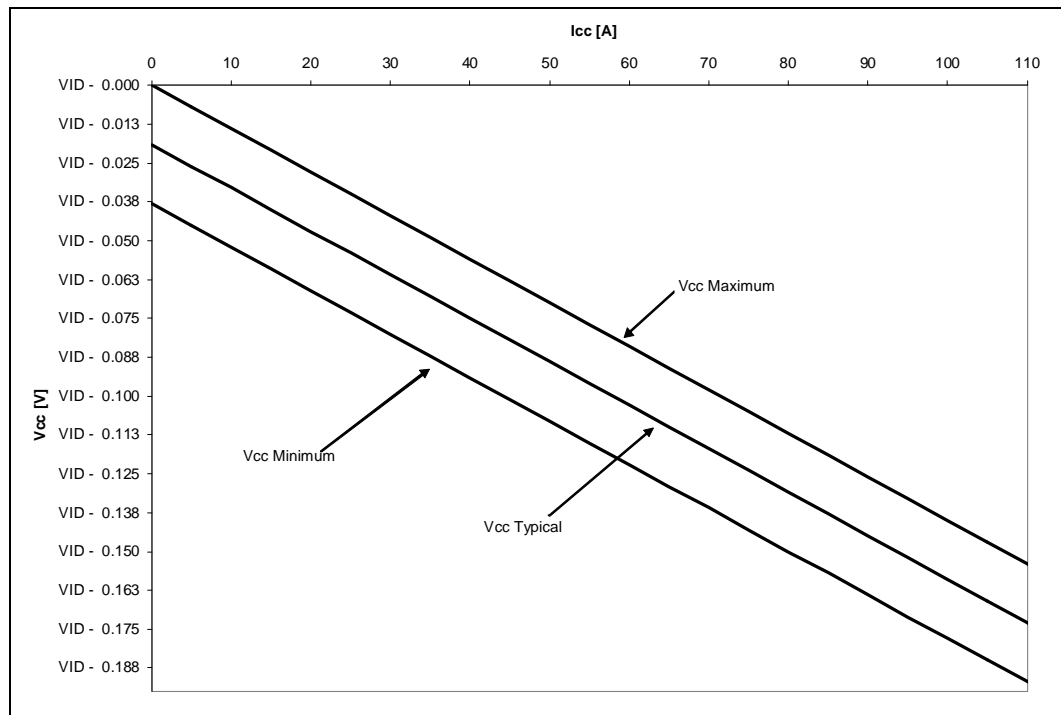



Table 7-8. DDR3 Signal Group DC Specifications

Symbol	Parameter	Alpha Group	Min	Typ	Max	Units	Notes ¹
V _{IL}	Input Low Voltage	(e,f)	—	—	0.43*V _{DDQ}	V	2,4
V _{IH}	Input High Voltage	(e,f)	0.57*V _{DDQ}	—	—	V	3
V _{OL}	Output Low Voltage	(c,d,e,f)	—	$(V_{DDQ} / 2) * (R_{ON} / (R_{ON} + R_{VTT_TERM}))$	—		6
V _{OH}	Output High Voltage	(c,d,e,f)	—	$V_{DDQ} - ((V_{DDQ} / 2) * (R_{ON} / (R_{ON} + R_{VTT_TERM})))$	—	V	4,6
R _{ON}	DDR3 Clock Buffer On Resistance	—	21	—	36	Ω	5
R _{ON}	DDR3 Command Buffer On Resistance	—	20	—	31	Ω	5
R _{ON}	DDR3 Control Buffer On Resistance	—	20	—	31	Ω	5
R _{ON}	DDR3 Data Buffer On Resistance	—	21	—	36	Ω	5
Data ODT	On-Die Termination for Data Signals	(d)	93.5	—	126.5	Ω	
I _{LI}	Input Leakage Current	—	—	—	± 1	mA	
SM_RCOMP0	COMP Resistance	(t)	99	100	101	Ω	7
SM_RCOMP1	COMP Resistance	(t)	24.7	24.9	25.1	Ω	7
SM_RCOMP2	COMP Resistance	(t)	128.7	130	131.3	Ω	7

Notes:

1. Unless otherwise noted, all specifications in this table apply to all processor frequencies.
2. V_{IL} is defined as the maximum voltage level at a receiving agent that will be interpreted as a logical low value.
3. V_{IH} is defined as the minimum voltage level at a receiving agent that will be interpreted as a logical high value.
4. V_{IH} and V_{OH} may experience excursions above V_{DDQ}. However, input signal drivers must comply with the signal quality specifications.
5. This is the pull down driver resistance.
6. R_{VTT_TERM} is the termination on the DIMM and is not controlled by the processor.
7. COMP resistance must be provided on the system board with 1% resistors. COMP resistors are to V_{SS}.



Table 7-9. Control Sideband and TAP Signal Group DC Specifications

Symbol	Alpha Group	Parameter	Min	Typ	Max	Units	Notes ¹
V _{IL}	(m), (n), (p), (qa), (qb), (s)	Input Low Voltage	—	—	0.64 × V _{TT}	V	2
V _{IH}	(m), (n), (p), (qa), (qb), (s)	Input High Voltage	0.76 × V _{TT}	—	—	V	2,4
V _{IL}	(g)	Input Low Voltage	—	—	0.40 × V _{TT}	V	2
V _{IH}	(g)	Input High Voltage	0.75 × V _{TT}	—	—	V	2,4
V _{IL}	(ja)	Input Low Voltage	—	—	0.25 × V _{TT}	V	2
V _{IH}	(ja)	Input High Voltage	0.75 × V _{TT}	—	—	V	2,4
V _{IL}	(jb)	Input Low Voltage	—	—	0.29	V	2
V _{IH}	(jb)	Input High Voltage	0.87	—	—	V	2,4
V _{OL}	(k), (l), (n), (p), (r), (s), (h), (i)	Output Low Voltage	—	—	$V_{TT} * R_{ON} / (R_{ON} + R_{SYS_TERM})$	V	2,6
V _{OH}	(k), (l), (n), (p), (r), (s), (i)	Output High Voltage	V _{TT}	—	—	V	2,4
R _{ON}	(ab)	Buffer on Resistance	20	—	45	Ω	
I _{LI}	(ja), (jb), (m), (n), (p), (qa), (s), (t), (g)	Input Leakage Current	—	—	±200	μA	3
I _{LI}	(qb)	Input Leakage Current	—	—	±100	μA	3
COMP0	(t)	COMP Resistance	49.4	49.9	50.4	Ω	5
COMP1	(t)	COMP Resistance	49.4	49.9	50.4	Ω	5
COMP2	(t)	COMP Resistance	19.8	20	20.2	Ω	5
COMP3	(t)	COMP Resistance	19.8	20	20.2	Ω	5

Notes:

1. Unless otherwise noted, all specifications in this table apply to all processor frequencies.
2. The V_{TT} referred to in these specifications refers to instantaneous V_{TT}.
3. For V_{IN} between 0 V and V_{TT}. Measured when the driver is tristated.
4. V_{IH} and V_{OH} may experience excursions above V_{TT}. However, input signal drivers must comply with the signal quality specifications.
5. COMP resistance must be provided on the system board with 1% resistors. COMP resistors are to V_{SS}.
6. R_{SYS_TERM} is the system termination on the signal.



Table 7-10. PCI Express* DC Specifications

Symbol	Alpha Group	Parameter	Min	Typ	Max	Units	Notes ¹
V _{TX-DIFF-p-p}	(ad)	Differential peak to peak Tx voltage swing	0.8	—	1.2	V	3
V _{TX_CM-AC-p}	(ad)	Tx AC Peak Common Mode Output Voltage (Gen1 only)	—	—	20	mV	1,2,6
V _{TX_CM-AC-p-p}	(ad)	Tx AC Peak-to-Peak Common Mode Output Voltage (Gen2 only)	—	—	100	mV	1,2
Z _{TX-DIFF-DC}	(ad)	DC Differential Tx Impedance (Gen1 only)	80	—	120	Ω	1,10
Z _{TX-DIFF-DC}	(ad)	DC Differential Tx Impedance (Gen2 only)	—	—	120	Ω	1,10
Z _{RX-DC}	(ac)	DC Common Mode Rx Impedance	40	—	60	Ω	1,8,9
Z _{RX-DIFF-DC}	(ac)	DC Differential Rx Impedance (Gen1 only)	80	—	120	Ω	1
V _{RX-DIFFp-p}	(ac)	Differential Rx input Peak to Peak Voltage (Gen1 only)	0.175	—	1.2	V	1
V _{RX-DIFFp-p}	(ac)	Differential Rx Input Peak to Peak Voltage (Gen2 only)	0.120	—	1.2	V	1,1
V _{RX_CM-AC-p}	(ac)	Rx AC peak Common Mode Input Voltage	—	—	150	mV	1,7
PEG_ICOMPO	(ae)	Comp Resistance	49.5	50	50.5	Ω	4,5
PEG_ICOMPI	(ae)	Comp Resistance	49.5	50	50.5	Ω	4,5
PEG_RCOMPO	(ae)	Comp Resistance	49.5	50	50.5	Ω	4,5
PEG_RBIAS	(ae)	Comp Resistance	742.5	750	757.5	Ω	4,5

Notes:

1. Refer to the *PCI Express Base Specification* for more details.
2. V_{TX-AC-CM-pp} and V_{TX-AC-CM-p} are defined in the *PCI Express Base Specification*. Measurement is made over at least 10⁶ UI.
3. As measured with compliance test load. Defined as 2*|V_{TXD+} - V_{TXD-}|.
4. COMP resistance must be provided on the system board with 1% resistors. COMP resistors are to V_{SS}.
5. PEG_ICOMPO, PEG_ICOMPI, PEG_RCOMPO are the same resistor
6. RMS value.
7. Measured at Rx pins into a pair of 50-Ω terminations into ground. Common mode peak voltage is defined by the expression: max{|(Vd+ - Vd-) - V-CMDC|}.
8. DC impedance limits are needed to guarantee Receiver detect.
9. The Rx DC Common Mode Impedance must be present when the Receiver terminations are first enabled to ensure that the Receiver Detect occurs properly. Compensation of this impedance can start immediately and the 15 Rx Common Mode Impedance (constrained by RLRX-CM to 50 Ω ±20%) must be within the specified range by the time Detect is entered.
10. Low impedance defined during signaling. Parameter is captured for 5.0 GHz by RLTX-DIFF.



7.10 Platform Environmental Control Interface (PECI) DC Specifications

PECI is an Intel proprietary interface that provides a communication channel between Intel processors and chipset components to external thermal monitoring devices. The processor contains a Digital Thermal Sensor (DTS) that reports a relative die temperature as an offset from Thermal Control Circuit (TCC) activation temperature. Temperature sensors located throughout the die are implemented as analog-to-digital converters calibrated at the factory. PECI provides an interface for external devices to read the DTS temperature for thermal management and fan speed control. For the PECI command set supported by the processor, refer to the appropriate processor Thermal and Mechanical Specifications and Design Guidelines for additional information (see [Section 1.7](#)).

7.10.1 DC Characteristics

The PECI interface operates at a nominal voltage set by V_{TT} . The set of DC electrical specifications shown in [Table 7-11](#) is used with devices normally operating from a V_{TT} interface supply. V_{TT} nominal levels will vary between processor families. All PECI devices will operate at the V_{TT} level determined by the processor installed in the system. For specific nominal V_{TT} levels, refer to [Table 7-6](#).

Table 7-11. PECI DC Electrical Limits

Symbol	Definition and Conditions	Min	Max	Units	Notes ¹
V_{in}	Input Voltage Range	-0.150	V_{TT}	V	
$V_{hysteresis}$	Hysteresis	$0.1 * V_{TT}$	N/A	V	
V_n	Negative-Edge Threshold Voltage	$0.275 * V_{TT}$	$0.500 * V_{TT}$	V	
V_p	Positive-Edge Threshold Voltage	$0.550 * V_{TT}$	$0.725 * V_{TT}$	V	
I_{source}	High-Level Output Source ($V_{OH} = 0.75 * V_{TT}$)	-6.0	N/A	mA	
I_{sink}	Low-Level Output Sink ($V_{OL} = 0.25 * V_{TT}$)	0.5	1.0	mA	
I_{leak+}	High Impedance State Leakage to V_{TT} ($V_{leak} = V_{OL}$)	N/A	100	μ A	2
I_{leak-}	High Impedance Leakage to GND ($V_{leak} = V_{OH}$)	N/A	100	μ A	2
C_{bus}	Bus Capacitance per Node	N/A	10	pF	
V_{noise}	Signal Noise Immunity above 300 MHz	$0.1 * V_{TT}$	N/A	V_{p-p}	

Notes:

- V_{TT} supplies the PECI interface. PECI behavior does not affect V_{TT} min/max specifications.
- The leakage specification applies to powered devices on the PECI bus.

7.10.2 Input Device Hysteresis

The input buffers in both client and host models must use a Schmitt-triggered input design for improved noise immunity. Use [Figure 7-2](#) as a guide for input buffer design.

Figure 7-2. Input Device Hysteresis

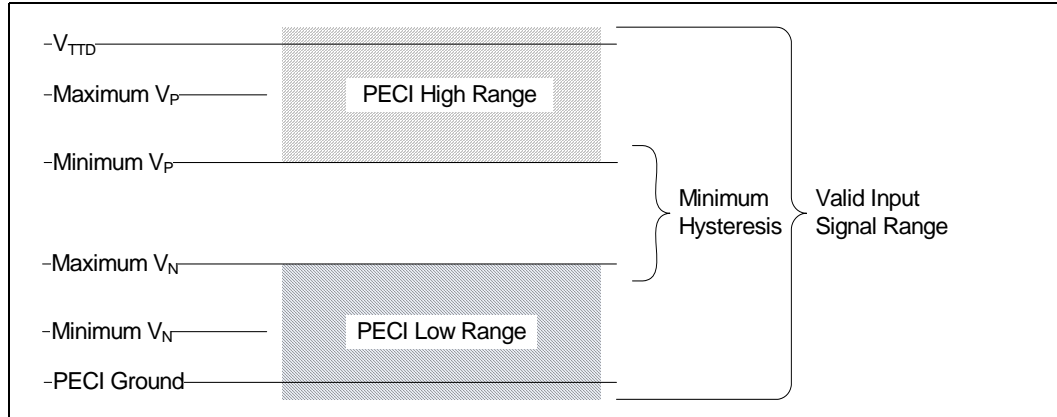

§ §



8 Processor Land and Signal Information

8.1 Processor Land Assignments

The processor land-map quadrants are shown in [Figure 8-1](#) through [Figure 8-4](#). [Table 8-2](#) provides a listing of all processor lands ordered alphabetically by pin name.

Not all signals listed in this chapter are used by the processor. [Table 8-1](#) lists the signals that are not used by the Intel Core™ i7-800 and i5-700 desktop processor series. The signals are included for reference to define all LGA 1156 land locations. These signals will be used by future processors that are compatible with LGA 1156 platforms.

Table 8-1. Signals Not Used by the Intel® Core™ i7-800 and i5-700 Desktop Processor Series

Interface	Signals Not Used
Intel Flexible Display Interface	FDI_FSYNC[1:0]
	FDI_LSYNC[1:0]
	FDI_INT
	FDI_TX[7:0]
	FDI_TX#[7:0]
Integrated Graphics Core Power	GFX_DPRSLPVR
	GFX_IMON
	GFX_VID[6:0]
	GFX_VR_EN
	VAXG
Memory	SA_DM[7:0]
	SB_DM[7:0]
Memory Interface: , ECC Related	SA_ECC_CB[7:0]
	SB_ECC_CB[7:0]
	SA_DQS[8]/SA_DQS#[8]
	SB_DQS[8]/SB_DQS#[8]
Memory Interface: RDIMM Related	SA_CS#[7:4]
	SB_CS#[7:4]



Figure 8-1. Socket Pinmap (Top View, Upper-Left Quadrant)

	40	39	38	37	36	35	34	33	32	31	30	29	28	27	26	25	24	23	22	21	
AY				RSVD_NCTF	VSS	SA_DQ[49]	SA_DQ[52]	VSS							SB_CS#[0]	VDDQ	SB_MA[10]	SA_ODT[3]	VDDQ		
AW			RSVD_NCTF	SA_DQ[55]	SA_DQS[6]	SA_DQ[48]	SA_DQ[53]	SA_DQ[47]	SA_DQS#[5]	SA_DM[5]	SA_DQ[45]	SB_CS#[1]	SB_MA[13]	SB_CAS#	SB_RAS#	SB_BS[1]	SA_CS#[1]	SA_ODT[2]			
AV		RSVD_NCTF	VSS	SA_DQ[50]	SA_DQ[54]	SA_DQS#[6]	VSS	SA_DQ[42]	SA_DQS[5]	VSS	SA_DQ[44]	SB_CS#[3]	VDDQ	SB_ODT[2]	SB_CS#[2]	VDDQ	SA_ODT[1]	SA_ODT[0]	VDDQ	SA_CS#[0]	
AU	RSVD_NCTF	SA_DQ[61]	SA_DQ[60]	SA_DQ[51]	VSS	SA_DM[6]	SA_DQ[43]	SA_DQ[46]	VSS	SA_DQ[41]	SA_DQ[40]	SB_ODT[1]	SB_ODT[3]	SB_ODT[0]	SB_WE#	SB_BS[0]	SA_MA[13]	SA_CS#[3]	SA_CAS#	SA_CS#[2]	
AT	SA_DQ[57]	SA_DQ[56]	SA_DM[7]	VSS	SB_DQ[49]	SB_DQ[53]	VSS	SB_DQ[47]	SB_DQ[40]	SB_DQ[44]	VSS	SA_DQS#[4]	SA_DQ[33]	VSS	SB_DQ[39]	SB_DQ[35]	VSS	SB_DQ[36]	SA_WE#	VDDQ	
AR	VSS	SA_DQS[7]	SA_DQS#[7]	SB_DQS[6]	SB_DQS[6]	SB_DQ[48]	SB_DQ[46]	SB_DQ[42]	SB_DQS#[5]	SB_DQ[45]	VSS	SA_DQ[38]	SA_DQS[4]	SA_DQ[37]	SB_DQ[35]	SB_DQ[34]	SB_DQS#[4]	VSS	SA_CK[0]	SA_CK#[0]	
AP	SA_DQ[63]	SA_DQ[62]	VSS	SB_DQ[55]	SB_DQ[51]	VSS	SB_DQ[52]	VSS	SB_DQ[55]	SB_DQ[41]	SA_DQ[35]	VSS	SA_DQ[34]	VSS	VSS	SB_DQ[33]	VSS	SB_DQ[33]	SB_DQ[31]	SA_CK#[2]	
AN	TMS	SA_DQ[59]	SA_DQ[58]	TCK	VSS	SB_DQ[60]	SB_DQ[54]	SB_DQ[50]	SB_DM[5]	VSS	SA_DQ[39]	SA_DM[4]	VSS	SA_DQ[32]	SA_DQ[36]	VSS	SB_DM[4]	SB_DQ[37]	VSS	SA_CK[2]	
AM	VSS	TRST#	TDO	TDI	SB_DQS#[7]	SB_DQ[57]	SB_DQ[61]	SB_DM[6]	SA_DQ[43]	BPM#[4]	RSVD	RSVD	RSVD	RSVD	RSVD	RSVD	SB_CS#[5]	SB_CS#[4]	SA_CS#[5]	RSVD	
AL	DBR#	RESET_OBS#	VSS	SB_DQS[7]	SB_DQ[63]	SB_DQ[56]	VSS	BPM#[0]	BPM#[1]	VSS	BPM#[5]	RSVD	VSS	RSVD	RSVD	VSS	SB_CS#[6]	SA_CS#[6]	VSS	VTT	
AK	BCLK_ITP#	BCLK_ITP	SKTOCC#	PREQ#	VSS	SB_DM[7]	TAPWRGOOD	BPM#[2]	BPM#[3]	BPM#[7]	BPM#[6]	RSVD	RSVD	RSVD	RSVD	RSVD	SB_CS#[7]	SA_CS#[7]	SA_CS#[4]	VTT	
AJ	VSS	RSVD	PRDY#		SB_DQ[59]	SB_DQ[58]	SB_DQ[62]	VSS	VSS	VTT	VTT	VSS	VTT	VSS	VTT	VSS	VTT	VSS	VTT	VSS	VTT
AH	RSVD	PM_SYNC	VSS	SB_DM[60]	VCCPWGOOD_1	VCCPWGOOD_0	PROCHOT#	VSS													
AG	FC_AG40	CATERR#	PSI#	VTPWRGOOD	VSS	PECI	VSS	VTT													
AF	VSS	VTT_S4L0C1	TDO_M	TDI_M	COMPO	THERMTRIP#	RSTIN#	VTT													
AE	VTT	VTT	FC_AE38	VSS	VSS_SENS#_VTT	VTT_SENSE	VTT	VTT													
AD	VTT	VTT	VTT	VTT	VTT	VTT	VTT	VTT													
AC	VTT	VTT	VTT	VTT	VTT	VTT	VTT	VTT													
AB	VSS	VSS	VSS	VSS	VSS	VSS	VSS	VSS													
AA			VTT	VTT	VTT	VTT	VTT	VTT													

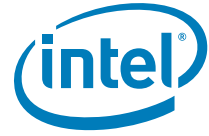

Figure 8-2. Socket Pinmap (Top View, Upper-Right Quadrant)

	20	19	18	17	16	15	14	13	12	11	10	9	8	7	6	5	4	3	2	1	
			SB_MA[4]	VDDQ	SB_MA[9]	SA_MA[1]	VDDQ	SA_MA[5]	SB_MA[14]	VDDQ	SA_CKE[3]	SB_CKE[1]	SA_DQ[27]	VSS	SA_DQS[3]	SA_DQ[25]	VSS	RSVD_NCTF			AY
			SA_MA[0]	SB_MA[6]	SB_MA[11]	SB_MA[12]	SA_MA[4]	SA_MA[7]	SA_MA[9]	SA_MA[12]	SA_CKE[1]	VDDQ	SB_CKE[0]	SA_DQ[31]	SA_DQS[13]	SA_DQ[24]	SA_DQ[19]	SA_DQ[18]	RSVD_NCTF		AW
SA_BS[0]	VDDQ		SB_MA[2]	SB_MA[5]	VDDQ	SA_MA[2]	SA_MA[6]	VDDQ	SB_BS[2]	SB_MA[15]	SA_CKE[2]	SB_CKE[3]	SM_DRMBS14	SA_DQ[30]	SA_DM[3]	SA_DQ[29]	SA_DQ[23]	VSS	SA_DQ[22]	RSVD_NCTF	AV
SB_MA[0]	SA_BS[1]	SB_MA[1]	SB_MA[3]	SB_MA[7]	SA_MA[3]	SA_MA[8]	SA_MA[11]	SA_BS[2]	VDDQ	SA_CKE[0]	SB_CKE[2]	SA_DQ[26]	VSS	VSS	SA_DQ[28]	SA_DQS[2]	SA_DQS[12]	SA_DQ[17]	SA_DM[2]		AU
SA_RAS#	SA_MA[10]	VDDQ	SB_MA[8]	VSS	SB_CK[1]	VSS	SB_CK[11]	VSS	SA_MA[14]	VDDQ	SB_DQ[31]	VSS	SB_DM[3]	SB_DQ[24]	VSS	SA_DQ[16]	SA_DQ[20]	VSS	SA_DQ[21]		AT
VSS	SB_CK[3]	SB_CK[3]	SB_CK[0]	SB_CK#0]	SB_CK#1]	SB_DQS[8]	SB_DQS[8]	SB_CK[0]	SA_MA[15]	SB_DQ[26]	SB_DQS[3]	SB_DQ[25]	SB_DQ[29]	SB_DQ[19]	SA_DQ[15]	SA_DQ[10]	SA_DQ[11]	VSS			AR
VSS	SA_CK[3]	SA_CK[1]	VSS	VSS	VSS	SB_CK[0]	SB_CK[0]	VSS	SA_CK[0]	SA_CK[0]	VSS	SB_DQS[13]	VSS	SB_DQ[16]	SB_DQ[23]	VSS	SA_DQS[11]	SA_DQS[1]	SA_DQ[14]		AP
VSS	SA_CK#3]	SA_CK#1]	SB_CK[2]	SB_CK#2]	SB_CK#2]	SB_CK[0]	SB_CK[0]	VSS	RSVD_TP	SA_CK[0]	VSS	SB_DQ[28]	SB_DQ[22]	SB_DQS[2]	SB_DQ[11]	VSS	SA_DQ[8]	SA_DQ[9]	SA_DM[1]		AN
RSVD	RSVD	RSVD	RSVD	RSVD	RSVD	RSVD	RSVD	RSVD	SB_CK[0]	SA_CK[0]	SA_DQS[8]	VSS	SB_DQ[27]	SB_DM[2]	SB_DQS[12]	VSS	SB_DQ[21]	SA_DQ[12]	SA_DQ[13]	VSS	AM
VTT	VSS	RSVD	RSVD	VSS	RSVD	RSVD	VSS	RSVD	VSS	SA_DQS[8]	SA_CK[0]	SB_DQ[30]	VSS	SB_DQ[16]	SB_DQ[20]	SB_DQ[11]	VSS	SA_DQ[2]	SA_DQ[3]		AL
VTT	VTT	RSVD	VSS	RSVD	RSVD	RSVD	RSVD	RSVD	SA_CK[0]	VSS	SA_CK[0]	VSS	SB_DQ[15]	SB_DQ[10]	VSS	VSS	SA_DQS[0]	SA_DQ[7]	SA_DQ[6]		AK
VSS	VTT	VSS	VTT	VSS	VDDQ	VSS	VDDQ	VSS	VDDQ		VSS	SB_DQ[3]	SB_DQ[14]	VSS	SB_DQS[11]	SA_DQ[1]	SA_DQS[9]	SA_DM[0]	VSS		AJ
													SB_DQ[2]	SB_DQ[9]	SB_DQS[1]	VSS	SB_DM[1]	VSS	SA_DQ[5]	SA_DQ[0]	AH
													VCCPLL	VSS	SB_DQ[12]	SB_DQ[8]	SB_DQ[13]	SM_DRMBS14	SA_DQ[4]	SM_RCOMP[0]	AG
													VCCPLL	VCCPLL	VSS	SB_DQ[6]	SB_DQS[0]	SM_DRMBS14	COMP1	VSS	AF
													VTT	VSS	SB_DQ[7]	SB_DQS[9]	SB_DM[0]	VSS	RSVD	SM_RCOMP[2]	AE
													VSS	SB_DQ[0]	SB_DQ[1]	VSS	FDI_LSYNC[0]	FDI_LSYNC[1]	RSVD	SM_RCOMP[1]	AD
													VTT	SB_DQ[4]	SB_DQ[5]	VTT	FDI_LSYNC[0]	FDI_LSYNC[1]	FDI_INT	VSS	AC
													VSS	VTT	VSS	SM_EXT_TSA[0]	SM_EXT_TSA[1]	VSS			AB
													BCLK[1]	BCLK[0]	BCLK#0]	VSS	PEG_CLK#	PEG_CLK			AA



Figure 8-3. Socket Pinmap (Top View, Lower-Left Quadrant)

Y		VTT	VTT	VTT	VTT	VTT	VTT												
W		VSS	VSS	VSS	VSS	VSS	VSS												
V	VTT	VTT	VTT	VTT	VTT	VTT	VTT												
U	VID[0]#MSR[0]	VID[1]#MSR[1]	VID[2]#MSR[2]	VID[3]#CSC[0]	VID[4]#CSC[1]	VID[5]#CSC[2]	VID[6]	VID[7]											
T	ISENSE	VSS	VSS	VSS	VSS	VCC_SENSE	VSS_SENSE	VSS											
R	VCC	VCC	VCC	VCC	VCC	VCC	VCC	VCC											
P	VCC	VCC	VCC	VCC	VCC	VCC	VCC	VCC											
N	VSS	VCC	VCC	VSS	VCC	VCC	VSS	VCC											
M	VCC	VCC	VSS	VCC	VCC	VSS	VCC	VCC	VSS										
L	VCC	VSS	VCC	VCC	VSS	VCC	VCC	VSS	VCC	VCC	VSS	VCC	VCC	VSS	VCC	VCC	VSS	VCC	VCC
K	VSS	VCC	VCC	VSS	VCC	VCC	VSS	VCC	VCC	VSS	VCC	VCC	VSS	VCC	VCC	VSS	VCC	VCC	VSS
J	VCC	VCC	VSS	VCC	VCC	VSS	VCC	VCC	VSS	VCC	VCC	VSS	VCC	VCC	VSS	VCC	VCC	VSS	VCC
H	VCC	VSS	VCC	VCC	VSS	VCC	VCC	VSS	VCC	VCC	VSS	VCC	VCC	VSS	VCC	VCC	VSS	VCC	VCC
G	VSS	VCC	VCC	VSS	VCC	VCC	VSS	VCC	VSS	VCC	VCC	VSS	VCC	VCC	VSS	VCC	VCC	VSS	VCC
F	VCC	VCC	VSS	VCC	VCC	VSS	VCC	VCC	VSS	VCC	VCC	VSS	VCC	VCC	VSS	VCC	VCC	VSS	VCC
E	VCC	VSS	VCC	VCC	VSS	VCC	VCC	VSS	VCC	VCC	VSS	VCC	VCC	VSS	VCC	VCC	VSS	VCC	VSS
D	VSS	VCC	VCC	VSS	VCC	VCC	VSS	VCC	VCC	VSS	VCC	VCC	VSS	VCC	VCC	VSS	VCC	VCC	VSS
C	VCC_NCTF	VCC	VSS	VCC	VCC	VSS	VCC	VCC	VSS	VCC	VCC	VSS	VCC	VCC	VSS	VCC	VCC	VCC	VSS
B		VCC_TP_NCTF	VCC	VCC	VSS	VCC	VCC	VSS	VCC	VCC	VSS	VCC	VCC	VSS	VCC	VCC	VSS	VCC	
A			VCC_NCTF	VSS	VCC	VCC	VSS	VCC						VSS	VCC	VCC	VSS	VCC	
		40	39	38	37	36	35	34	33	32	31	30	29	28	27	26	25	24	23
																			22
																			21

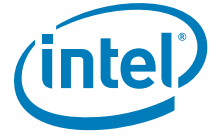

Figure 8-4. Socket Pinmap (Top View, Lower-Right Quadrant)

																		BLK#(1)	VSS	FDL_TX(7)	FDL_TX(7)	FDL_TX(6)	FDL_TX(6)					Y	
																		DL_TX(3)	FDL_TX(3)	VTT	FDL_TX(4)	FDL_TX(4)	DMI_RX(3)	DMI_RX(3)	VTT				W
																		VTT	VTT	VTT	VSS	FDL_TX(1)	FDL_TX(1)	VTT	DMI_RX(2)				V
																		DL_TX(2)	FDL_TX(2)	FDL_TX(0)	FDL_TX(0)	VSS	DMI_RX(1)	DMI_RX(1)	DMI_RX(1)				U
																		VTT	VTT	VTT	VSS	PEG_RX(15)	PEG_RX(13)	VTT	DMI_RX(1)				T
																		DL_TX(5)	FDL_TX(5)	PEG_TX(15)	PEG_TX(15)	VSS	DMI_TX(3)	DMI_TX(3)	DMI_RX(0)				R
																		VTT	VTT	VTT	VSS	PEG_RX(14)	PEG_RX(14)	VSS	DMI_TX(2)				P
																		PEG_TX(11)	VTT	PEG_TX(13)	PEG_TX(13)	VSS	DMI_TX(1)	DMI_TX(1)	DMI_TX(2)				N
VSS	VCC	VSS	VCC	VAXG	VAXG	VAXG	VSS	RSVD	VTT	VTT	VTT	PEG_TX(9)	VSS	VSS	VSS	PEG_TX(11)	PEG_TX(11)	VSS	DMI_TX(0)	M									
VCC	VCC	VSS	VCC	VAXG	VAXG	VAXG	VSS	RSVD	CFG[17]	VTT	VSS	CFG[13]	PEG_TX(10)	PEG_TX(10)	PEG_TX(10)	VSS	PEG_RX(13)	PEG_RX(13)	DMI_TX(1)	L									
VCC	VSS	VCC	VCC	VAXG	VAXG	VAXG	VSS	CFG[15]	VSS	CFG[10]	CFG[14]	CFG[11]	PEG_TX(8)	VSS	VSS	PEG_TX(8)	PEG_TX(8)	VSS	PEG_RX(11)	K									
VSS	VCC	VCC	VSS	VAXG	VAXG	VAXG	VSS	CFG[12]	GFX_VID(6)	GFX_DMON[6]	VSS	PEG_TX(9)	VSS	PEG_TX(7)	PEG_TX(7)	VSS	PEG_RX(11)	PEG_RX(11)	PEG_RX(12)	J									
VCC	VCC	VSS	VAXG	VSS	VAXG	VAXG	VSS	CFG[9]	VSS	CFG[4]	CFG[5]	PEG_TX(9)	CFG[16]	VSS	VSS	PEG_TX(5)	PEG_TX(10)	VSS	PEG_RX(10)	H									
VCC	VSS	VAXG	VAXG	VSS	VAXG	VAXG	VSS	CFG[8]	GFX_VID(5)	GFX_VID(0)	VSS	CFG[1]	PEG_TX(4)	PEG_TX(4)	PEG_TX(4)	VSS	PEG_RX(9)	PEG_RX(9)	PEG_RX(9)	G									
VSS	VAXG	VAXG	VAXG	VSS	VAXG	VAXG	VSS	GFX_VR_EN	VSS	CFG[3]	CFG[7]	VSS	PEG_TX(9)	GFX_MON	PEG_TX(1)	PEG_TX(3)	VSS	PEG_RX(8)			F								
VAXG	VSS	VAXG	VAXG	VSS	VAXG	VAXG	VSS	GFX_VID(2)	GFX_VID(3)	CFG[2]	CFG[6]	CFG[0]	PEG_TX(1)	PEG_TX(1)	PEG_TX(2)	VSS	VSS	PEG_RX(1)	PEG_RX(1)	E									
VAXG	VSS	VAXG	VAXG	VSS	VAXG	VAXG	VSS	VSS	PEG_I_COMPI	VSS	PEG_RX(0)	VSS	PEG_TX(0)	VSS	VSS	VSS	PEG_RX(6)	PEG_RX(7)	RSVD_NCTF	D									
VAXG	VSS	VAXG	VAXG	VSS	VAXG	VAXG	VSS	GFX_VID(4)	COMP3	PEG_I_COMP3	PEG_RX(0)	PEG_RX(1)	PEG_TX(0)	PEG_RX(3)	VSS	PEG_RX(5)	PEG_RX(6)	RSVD_NCTF			C								
		VAXG	VAXG	VSS	VAXG	VAXG	VSS	HSHG_SINK	GFX_VID(1)	COMP2	PEG_I_COMP2	VSS	PEG_RX(1)	VSS	PEG_RX(3)	PEG_RX(4)	PEG_RX(5)	RSVD_NCTF			B								
		VAXG	VAXG	VSS	VAXG	VAXG	VSS	VAXG Sense	RSVD	PEG_RBBIAS			PEG_RX(2)	PEG_RX(12)	PEG_RX(4)	RSVD_NCTF					A								
20	19	18	17	16	15	14	13	12	11	10	9	8	7	6	5	4	3	2	1										



Table 8-2. Processor Pin List by Pin Name

Pin Name	Pin #	Buffer Type	Dir.
BCLK_I TP	AK39	CMOS	O
BCLK_I TP#	AK40	CMOS	O
BCLK[0]	AA7	CMOS	I
BCLK[1]	AA8	Diff Clk	I
BCLK#[0]	AA6	CMOS	I
BCLK#[1]	Y8	Diff Clk	I
BPM#[0]	AL33	GTL	I/O
BPM#[1]	AL32	GTL	I/O
BPM#[2]	AK33	GTL	I/O
BPM#[3]	AK32	GTL	I/O
BPM#[4]	AM31	GTL	I/O
BPM#[5]	AL30	GTL	I/O
BPM#[6]	AK30	GTL	I/O
BPM#[7]	AK31	GTL	I/O
CATERR#	AG39	GTL	I/O
CFG[0]	E8	CMOS	I
CFG[1]	G8	CMOS	I
CFG[10]	K10	CMOS	I
CFG[11]	K8	CMOS	I
CFG[12]	J12	CMOS	I
CFG[13]	L8	CMOS	I
CFG[14]	K9	CMOS	I
CFG[15]	K12	CMOS	I
CFG[16]	H7	CMOS	I
CFG[17]	L11	CMOS	I
CFG[2]	E10	CMOS	I
CFG[3]	F10	CMOS	I
CFG[4]	H10	CMOS	I
CFG[5]	H9	CMOS	I
CFG[6]	E9	CMOS	I
CFG[7]	F9	CMOS	I
CFG[8]	G12	CMOS	I
CFG[9]	H12	CMOS	I
CGC_TP_NCTF	B39		
COMP0	AF36	Analog	I
COMP1	AF2	Analog	I
COMP2	B11	Analog	I
COMP3	C11	Analog	I
DBR#	AL40		O
SA_DIMM_VREFDQ	AF3	Analog	O
SB_DIMM_VREFDQ	AG3	Analog	O
DMI_RX[0]	R1	DMI	I
DMI_RX[1]	U3	DMI	I
DMI_RX[2]	U1	DMI	I

Table 8-2. Processor Pin List by Pin Name

Pin Name	Pin #	Buffer Type	Dir.
DMI_RX[3]	W3	DMI	I
DMI_RX#[0]	T1	DMI	I
DMI_RX#[1]	U2	DMI	I
DMI_RX#[2]	V1	DMI	I
DMI_RX#[3]	W2	DMI	I
DMI_TX[0]	L1	DMI	O
DMI_TX[1]	N3	DMI	O
DMI_TX[2]	N1	DMI	O
DMI_TX[3]	R2	DMI	O
DMI_TX#[0]	M1	DMI	O
DMI_TX#[1]	N2	DMI	O
DMI_TX#[2]	P1	DMI	O
DMI_TX#[3]	R3	DMI	O
FC_AE38	AE38		
FC_AG40	AG40		
FDI_FSYNC[0]	AC4	CMOS	I
FDI_FSYNC[1]	AC3	CMOS	I
FDI_INT	AC2	CMOS	I
FDI_LSYNC[0]	AD4	CMOS	I
FDI_LSYNC[1]	AD3	CMOS	I
FDI_TX[0]	U6	FDI	O
FDI_TX[1]	V4	FDI	O
FDI_TX[2]	U8	FDI	O
FDI_TX[3]	W8	FDI	O
FDI_TX[4]	W5	FDI	O
FDI_TX[5]	R8	FDI	O
FDI_TX[6]	Y4	FDI	O
FDI_TX[7]	Y6	FDI	O
FDI_TX#[0]	U5	FDI	O
FDI_TX#[1]	V3	FDI	O
FDI_TX#[2]	U7	FDI	O
FDI_TX#[3]	W7	FDI	O
FDI_TX#[4]	W4	FDI	O
FDI_TX#[5]	R7	FDI	O
FDI_TX#[6]	Y3	FDI	O
FDI_TX#[7]	Y5	FDI	O
GFX DPRSLPVR	J10	CMOS	O
GFX_IMON	F6	Analog	I
GFX_VID[0]	G10	CMOS	O
GFX_VID[1]	B12	CMOS	O
GFX_VID[2]	E12	CMOS	O
GFX_VID[3]	E11	CMOS	O
GFX_VID[4]	C12	CMOS	O
GFX_VID[5]	G11	CMOS	O

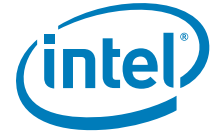

Table 8-2. Processor Pin List by Pin Name

Pin Name	Pin #	Buffer Type	Dir.
GFX_VID[6]	J11	CMOS	O
GFX_VR_EN	F12	CMOS	O
ISENSE	T40	Analog	I
PECI	AG35	Asynch	I/O
PEG_CLK	AA3	Diff Clk	I
PEG_CLK#	AA4	Diff Clk	I
PEG_ICOMPI	D11	Analog	I
PEG_ICOMPO	C10	Analog	I
PEG_RBIAAS	A11	Analog	I
PEG_RCOMPO	B10	Analog	I
PEG_RX[0]	C9	PCI Express	I
PEG_RX[1]	B8	PCI Express	I
PEG_RX[10]	G1	PCI Express	I
PEG_RX[11]	J3	PCI Express	I
PEG_RX[12]	J1	PCI Express	I
PEG_RX[13]	L2	PCI Express	I
PEG_RX[14]	P3	PCI Express	I
PEG_RX[15]	T3	PCI Express	I
PEG_RX[2]	A7	PCI Express	I
PEG_RX[3]	B6	PCI Express	I
PEG_RX[4]	A5	PCI Express	I
PEG_RX[5]	B4	PCI Express	I
PEG_RX[6]	C3	PCI Express	I
PEG_RX[7]	D2	PCI Express	I
PEG_RX[8]	E1	PCI Express	I
PEG_RX[9]	G3	PCI Express	I
PEG_RX#[0]	D9	PCI Express	I
PEG_RX#[1]	C8	PCI Express	I
PEG_RX#[10]	H1	PCI Express	I
PEG_RX#[11]	J2	PCI Express	I
PEG_RX#[12]	K1	PCI Express	I
PEG_RX#[13]	L3	PCI Express	I
PEG_RX#[14]	P4	PCI Express	I
PEG_RX#[15]	T4	PCI Express	I
PEG_RX#[2]	A6	PCI Express	I
PEG_RX#[3]	C6	PCI Express	I
PEG_RX#[4]	B5	PCI Express	I
PEG_RX#[5]	C4	PCI Express	I
PEG_RX#[6]	D3	PCI Express	I
PEG_RX#[7]	E2	PCI Express	I
PEG_RX#[8]	F1	PCI Express	I
PEG_RX#[9]	G2	PCI Express	I
PEG_TX[0]	C7	PCI Express	O
PEG_TX[1]	E7	PCI Express	O

Table 8-2. Processor Pin List by Pin Name

Pin Name	Pin #	Buffer Type	Dir.
PEG_TX[10]	L6	PCI Express	O
PEG_TX[11]	M4	PCI Express	O
PEG_TX[12]	K7	PCI Express	O
PEG_TX[13]	N6	PCI Express	O
PEG_TX[14]	M8	PCI Express	O
PEG_TX[15]	R5	PCI Express	O
PEG_TX[2]	E5	PCI Express	O
PEG_TX[3]	F3	PCI Express	O
PEG_TX[4]	G6	PCI Express	O
PEG_TX[5]	H4	PCI Express	O
PEG_TX[6]	F7	PCI Express	O
PEG_TX[7]	J6	PCI Express	O
PEG_TX[8]	K3	PCI Express	O
PEG_TX[9]	H8	PCI Express	O
PEG_TX#[0]	D7	PCI Express	O
PEG_TX#[1]	E6	PCI Express	O
PEG_TX#[10]	L5	PCI Express	O
PEG_TX#[11]	M3	PCI Express	O
PEG_TX#[12]	L7	PCI Express	O
PEG_TX#[13]	N5	PCI Express	O
PEG_TX#[14]	N8	PCI Express	O
PEG_TX#[15]	R6	PCI Express	O
PEG_TX#[2]	F5	PCI Express	O
PEG_TX#[3]	F4	PCI Express	O
PEG_TX#[4]	G5	PCI Express	O
PEG_TX#[5]	H3	PCI Express	O
PEG_TX#[6]	G7	PCI Express	O
PEG_TX#[7]	J5	PCI Express	O
PEG_TX#[8]	K4	PCI Express	O
PEG_TX#[9]	J8	PCI Express	O
PM_EXT_TS#[0]	AB5	CMOS	I
PM_EXT_TS#[1]	AB4	CMOS	I
PM_SYNC	AH39	CMOS	I
PRDY#	AJ38	Asynch GTL	O
PREQ#	AK37	Asynch GTL	I
PROCHOT#	AH34	Asynch GTL	I/O
PSI#	AG38	Asynch CMOS	O
RESET_OBS#	AL39	Asynch CMOS	O
RSTIN#	AF34	CMOS	I
RSVD	A12		
RSVD	AD2		
RSVD	AE2		
RSVD	AH40		
RSVD	AJ39		

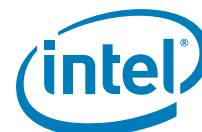

Table 8-2. Processor Pin List by Pin Name

Pin Name	Pin #	Buffer Type	Dir.
RSVD	AK12		
RSVD	AK13		
RSVD	AK14		
RSVD	AK15		
RSVD	AK16		
RSVD	AK18		
RSVD	AK25		
RSVD	AK26		
RSVD	AK27		
RSVD	AK28		
RSVD	AK29		
RSVD	AL12		
RSVD	AL14		
RSVD	AL15		
RSVD	AL17		
RSVD	AL18		
RSVD	AL26		
RSVD	AL27		
RSVD	AL29		
RSVD	AM13		
RSVD	AM14		
RSVD	AM15		
RSVD	AM16		
RSVD	AM17		
RSVD	AM18		
RSVD	AM19		
RSVD	AM20		
RSVD	AM21		
RSVD	AM25		
RSVD	AM26		
RSVD	AM27		
RSVD	AM28		
RSVD	AM29		
RSVD	AM30		
RSVD	L12		
RSVD	M12		
RSVD_NCTF	A4		
RSVD_NCTF	AU40		
RSVD_NCTF	AV1		
RSVD_NCTF	AV39		
RSVD_NCTF	AW2		
RSVD_NCTF	AW38		
RSVD_NCTF	AY3		
RSVD_NCTF	AY37		

Table 8-2. Processor Pin List by Pin Name

Pin Name	Pin #	Buffer Type	Dir.
RSVD_NCTF	B3		
RSVD_NCTF	C2		
RSVD_NCTF	D1		
RSVD_TP	AN11		
SA_BS[0]	AV20	DDR3	O
SA_BS[1]	AU19	DDR3	O
SA_BS[2]	AU12	DDR3	O
SA_CAS#	AU22	DDR3	O
SA_CK[0]	AR22	DDR3	O
SA_CK[1]	AP18	DDR3	O
SA_CK[2]	AN21	DDR3	O
SA_CK[3]	AP19	DDR3	O
SA_CK#[0]	AR21	DDR3	O
SA_CK#[1]	AN18	DDR3	O
SA_CK#[2]	AP21	DDR3	O
SA_CK#[3]	AN19	DDR3	O
SA_CKE[0]	AU10	DDR3	O
SA_CKE[1]	AW10	DDR3	O
SA_CKE[2]	AV10	DDR3	O
SA_CKE[3]	AY10	DDR3	O
SA_CS#[0]	AV21	DDR3	O
SA_CS#[1]	AW24	DDR3	O
SA_CS#[2]	AU21	DDR3	O
SA_CS#[3]	AU23	DDR3	O
SA_CS#[4]	AK22	DDR3	O
SA_CS#[5]	AM22	DDR3	O
SA_CS#[6]	AL23	DDR3	O
SA_CS#[7]	AK23	DDR3	O
SA_DM[0]	AJ2	DDR3	O
SA_DM[1]	AN1	DDR3	O
SA_DM[2]	AU1	DDR3	O
SA_DM[3]	AV6	DDR3	I/O
SA_DM[4]	AN29	DDR3	O
SA_DM[5]	AW31	DDR3	O
SA_DM[6]	AU35	DDR3	O
SA_DM[7]	AT38	DDR3	O
SA_DQ[0]	AH1	DDR3	I/O
SA_DQ[1]	AJ4	DDR3	I/O
SA_DQ[10]	AR3	DDR3	I/O
SA_DQ[11]	AR2	DDR3	I/O
SA_DQ[12]	AM3	DDR3	I/O
SA_DQ[13]	AM2	DDR3	I/O
SA_DQ[14]	AP1	DDR3	I/O
SA_DQ[15]	AR4	DDR3	I/O

Table 8-2. Processor Pin List by Pin Name

Pin Name	Pin #	Buffer Type	Dir.
SA_DQ[16]	AT4	DDR3	I/O
SA_DQ[17]	AU2	DDR3	I/O
SA_DQ[18]	AW3	DDR3	I/O
SA_DQ[19]	AW4	DDR3	I/O
SA_DQ[2]	AL2	DDR3	I/O
SA_DQ[20]	AT3	DDR3	I/O
SA_DQ[21]	AT1	DDR3	I/O
SA_DQ[22]	AV2	DDR3	I/O
SA_DQ[23]	AV4	DDR3	I/O
SA_DQ[24]	AW5	DDR3	I/O
SA_DQ[25]	AY5	DDR3	I/O
SA_DQ[26]	AU8	DDR3	I/O
SA_DQ[27]	AY8	DDR3	I/O
SA_DQ[28]	AU5	DDR3	I/O
SA_DQ[29]	AV5	DDR3	I/O
SA_DQ[3]	AL1	DDR3	I/O
SA_DQ[30]	AV7	DDR3	I/O
SA_DQ[31]	AW7	DDR3	I/O
SA_DQ[32]	AN27	DDR3	I/O
SA_DQ[33]	AT28	DDR3	I/O
SA_DQ[34]	AP28	DDR3	I/O
SA_DQ[35]	AP30	DDR3	I/O
SA_DQ[36]	AN26	DDR3	I/O
SA_DQ[37]	AR27	DDR3	I/O
SA_DQ[38]	AR29	DDR3	I/O
SA_DQ[39]	AN30	DDR3	I/O
SA_DQ[4]	AG2	DDR3	I/O
SA_DQ[40]	AU30	DDR3	I/O
SA_DQ[41]	AU31	DDR3	I/O
SA_DQ[42]	AV33	DDR3	I/O
SA_DQ[43]	AU34	DDR3	I/O
SA_DQ[44]	AV30	DDR3	I/O
SA_DQ[45]	AW30	DDR3	I/O
SA_DQ[46]	AU33	DDR3	I/O
SA_DQ[47]	AW33	DDR3	I/O
SA_DQ[48]	AW35	DDR3	I/O
SA_DQ[49]	AY35	DDR3	I/O
SA_DQ[5]	AH2	DDR3	I/O
SA_DQ[50]	AV37	DDR3	I/O
SA_DQ[51]	AU37	DDR3	I/O
SA_DQ[52]	AY34	DDR3	I/O
SA_DQ[53]	AW34	DDR3	I/O
SA_DQ[54]	AV36	DDR3	I/O
SA_DQ[55]	AW37	DDR3	I/O

Table 8-2. Processor Pin List by Pin Name

Pin Name	Pin #	Buffer Type	Dir.
SA_DQ[56]	AT39	DDR3	I/O
SA_DQ[57]	AT40	DDR3	I/O
SA_DQ[58]	AN38	DDR3	I/O
SA_DQ[59]	AN39	DDR3	I/O
SA_DQ[6]	AK1	DDR3	I/O
SA_DQ[60]	AU38	DDR3	I/O
SA_DQ[61]	AU39	DDR3	I/O
SA_DQ[62]	AP39	DDR3	I/O
SA_DQ[63]	AP40	DDR3	I/O
SA_DQ[7]	AK2	DDR3	I/O
SA_DQ[8]	AN3	DDR3	I/O
SA_DQ[9]	AN2	DDR3	I/O
SA_DQS[0]	AK3	DDR3	I/O
SA_DQS[1]	AP2	DDR3	I/O
SA_DQS[2]	AU4	DDR3	I/O
SA_DQS[3]	AY6	DDR3	I/O
SA_DQS[4]	AR28	DDR3	I/O
SA_DQS[5]	AV32	DDR3	I/O
SA_DQS[6]	AW36	DDR3	I/O
SA_DQS[7]	AR39	DDR3	I/O
SA_DQS[8]	AL10	DDR3	I/O
SA_DQS#[0]	AJ3	DDR3	I/O
SA_DQS#[1]	AP3	DDR3	I/O
SA_DQS#[2]	AU3	DDR3	I/O
SA_DQS#[3]	AW6	DDR3	I/O
SA_DQS#[4]	AT29	DDR3	I/O
SA_DQS#[5]	AW32	DDR3	I/O
SA_DQS#[6]	AV35	DDR3	I/O
SA_DQS#[7]	AR38	DDR3	I/O
SA_DQS#[8]	AM10	DDR3	I/O
SA_ECC_CB[0]	AP10	DDR3	I/O
SA_ECC_CB[1]	AN10	DDR3	I/O
SA_ECC_CB[2]	AR11	DDR3	I/O
SA_ECC_CB[3]	AP11	DDR3	I/O
SA_ECC_CB[4]	AK9	DDR3	I/O
SA_ECC_CB[5]	AL9	DDR3	I/O
SA_ECC_CB[6]	AK11	DDR3	I/O
SA_ECC_CB[7]	AM11	DDR3	I/O
SA_MA[0]	AW18	DDR3	O
SA_MA[1]	AY15	DDR3	O
SA_MA[10]	AT19	DDR3	O
SA_MA[11]	AU13	DDR3	O
SA_MA[12]	AW11	DDR3	O
SA_MA[13]	AU24	DDR3	O



Table 8-2. Processor Pin List by Pin Name

Pin Name	Pin #	Buffer Type	Dir.
SA_MA[14]	AT11	DDR3	O
SA_MA[15]	AR10	DDR3	O
SA_MA[2]	AV15	DDR3	O
SA_MA[3]	AU15	DDR3	O
SA_MA[4]	AW14	DDR3	O
SA_MA[5]	AY13	DDR3	O
SA_MA[6]	AV14	DDR3	O
SA_MA[7]	AW13	DDR3	O
SA_MA[8]	AU14	DDR3	O
SA_MA[9]	AW12	DDR3	O
SA_ODT[0]	AV23	DDR3	O
SA_ODT[1]	AV24	DDR3	O
SA_ODT[2]	AW23	DDR3	O
SA_ODT[3]	AY24	DDR3	O
SA_RAS#	AT20	DDR3	O
SA_WE#	AT22	DDR3	O
SB_BS[0]	AU25	DDR3	O
SB_BS[1]	AW25	DDR3	O
SB_BS[2]	AV12	DDR3	O
SB_CAS#	AW27	DDR3	O
SB_CK[0]	AR17	DDR3	O
SB_CK[1]	AT15	DDR3	O
SB_CK[2]	AN17	DDR3	O
SB_CK[3]	AR19	DDR3	O
SB_CK#[0]	AR16	DDR3	O
SB_CK#[1]	AR15	DDR3	O
SB_CK#[2]	AN16	DDR3	O
SB_CK#[3]	AR18	DDR3	O
SB_CKE[0]	AW8	DDR3	O
SB_CKE[1]	AY9	DDR3	O
SB_CKE[2]	AU9	DDR3	O
SB_CKE[3]	AV9	DDR3	O
SB_CS#[0]	AY27	DDR3	O
SB_CS#[1]	AW29	DDR3	O
SB_CS#[2]	AV26	DDR3	O
SB_CS#[3]	AV29	DDR3	O
SB_CS#[4]	AM23	DDR3	O
SB_CS#[5]	AM24	DDR3	O
SB_CS#[6]	AL24	DDR3	O
SB_CS#[7]	AK24	DDR3	O
SB_DM[0]	AE4	DDR3	O
SB_DM[1]	AH4	DDR3	O
SB_DM[2]	AM7	DDR3	O
SB_DM[3]	AT7	DDR3	O

Table 8-2. Processor Pin List by Pin Name

Pin Name	Pin #	Buffer Type	Dir.
SB_DM[4]	AN24	DDR3	O
SB_DM[5]	AN32	DDR3	O
SB_DM[6]	AM33	DDR3	O
SB_DM[7]	AK35	DDR3	O
SB_DQ[0]	AD7	DDR3	I/O
SB_DQ[1]	AD6	DDR3	I/O
SB_DQ[10]	AK6	DDR3	I/O
SB_DQ[11]	AL4	DDR3	I/O
SB_DQ[12]	AG6	DDR3	I/O
SB_DQ[13]	AG4	DDR3	I/O
SB_DQ[14]	AJ7	DDR3	I/O
SB_DQ[15]	AK7	DDR3	I/O
SB_DQ[16]	AL6	DDR3	I/O
SB_DQ[17]	AN5	DDR3	I/O
SB_DQ[18]	AP6	DDR3	I/O
SB_DQ[19]	AR5	DDR3	I/O
SB_DQ[2]	AH8	DDR3	I/O
SB_DQ[20]	AL5	DDR3	I/O
SB_DQ[21]	AM4	DDR3	I/O
SB_DQ[22]	AN7	DDR3	I/O
SB_DQ[23]	AP5	DDR3	I/O
SB_DQ[24]	AT6	DDR3	I/O
SB_DQ[25]	AR7	DDR3	I/O
SB_DQ[26]	AR9	DDR3	I/O
SB_DQ[27]	AM8	DDR3	I/O
SB_DQ[28]	AN8	DDR3	I/O
SB_DQ[29]	AR6	DDR3	I/O
SB_DQ[3]	AJ8	DDR3	I/O
SB_DQ[30]	AL8	DDR3	I/O
SB_DQ[31]	AT9	DDR3	I/O
SB_DQ[32]	AN23	DDR3	I/O
SB_DQ[33]	AP23	DDR3	I/O
SB_DQ[34]	AR25	DDR3	I/O
SB_DQ[35]	AR26	DDR3	I/O
SB_DQ[36]	AT23	DDR3	I/O
SB_DQ[37]	AP22	DDR3	I/O
SB_DQ[38]	AP25	DDR3	I/O
SB_DQ[39]	AT26	DDR3	I/O
SB_DQ[4]	AC7	DDR3	I/O
SB_DQ[40]	AT32	DDR3	I/O
SB_DQ[41]	AP31	DDR3	I/O
SB_DQ[42]	AR33	DDR3	I/O
SB_DQ[43]	AM32	DDR3	I/O
SB_DQ[44]	AT31	DDR3	I/O

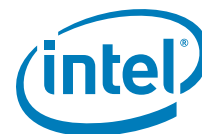

Table 8-2. Processor Pin List by Pin Name

Pin Name	Pin #	Buffer Type	Dir.
SB_DQ[45]	AR31	DDR3	I/O
SB_DQ[46]	AR34	DDR3	I/O
SB_DQ[47]	AT33	DDR3	I/O
SB_DQ[48]	AR35	DDR3	I/O
SB_DQ[49]	AT36	DDR3	I/O
SB_DQ[5]	AC6	DDR3	I/O
SB_DQ[50]	AN33	DDR3	I/O
SB_DQ[51]	AP36	DDR3	I/O
SB_DQ[52]	AP34	DDR3	I/O
SB_DQ[53]	AT35	DDR3	I/O
SB_DQ[54]	AN34	DDR3	I/O
SB_DQ[55]	AP37	DDR3	I/O
SB_DQ[56]	AL35	DDR3	I/O
SB_DQ[57]	AM35	DDR3	I/O
SB_DQ[58]	AJ36	DDR3	I/O
SB_DQ[59]	AJ37	DDR3	I/O
SB_DQ[6]	AF5	DDR3	I/O
SB_DQ[60]	AN35	DDR3	I/O
SB_DQ[61]	AM34	DDR3	I/O
SB_DQ[62]	AJ35	DDR3	I/O
SB_DQ[63]	AL36	DDR3	I/O
SB_DQ[7]	AE6	DDR3	I/O
SB_DQ[8]	AG5	DDR3	I/O
SB_DQ[9]	AH7	DDR3	I/O
SB_DQS[0]	AF4	DDR3	I/O
SB_DQS[1]	AH6	DDR3	I/O
SB_DQS[2]	AN6	DDR3	I/O
SB_DQS[3]	AR8	DDR3	I/O
SB_DQS[4]	AT25	DDR3	I/O
SB_DQS[5]	AP32	DDR3	I/O
SB_DQS[6]	AR36	DDR3	I/O
SB_DQS[7]	AL37	DDR3	I/O
SB_DQS[8]	AR14	DDR3	I/O
SB_DQS#[0]	AE5	DDR3	I/O
SB_DQS#[1]	AJ5	DDR3	I/O
SB_DQS#[2]	AM6	DDR3	I/O
SB_DQS#[3]	AP8	DDR3	I/O
SB_DQS#[4]	AR24	DDR3	I/O
SB_DQS#[5]	AR32	DDR3	I/O
SB_DQS#[6]	AR37	DDR3	I/O
SB_DQS#[7]	AM36	DDR3	I/O
SB_DQS#[8]	AR13	DDR3	I/O
SB_ECC_CB[0]	AR12	DDR3	I/O
SB_ECC_CB[1]	AT13	DDR3	I/O

Table 8-2. Processor Pin List by Pin Name

Pin Name	Pin #	Buffer Type	Dir.
SB_ECC_CB[2]	AN15	DDR3	I/O
SB_ECC_CB[3]	AP14	DDR3	I/O
SB_ECC_CB[4]	AM12	DDR3	I/O
SB_ECC_CB[5]	AN12	DDR3	I/O
SB_ECC_CB[6]	AN14	DDR3	I/O
SB_ECC_CB[7]	AP13	DDR3	I/O
SB_MA[0]	AU20	DDR3	O
SB_MA[1]	AU18	DDR3	O
SB_MA[10]	AY25	DDR3	O
SB_MA[11]	AW16	DDR3	O
SB_MA[12]	AW15	DDR3	O
SB_MA[13]	AW28	DDR3	O
SB_MA[14]	AY12	DDR3	O
SB_MA[15]	AV11	DDR3	O
SB_MA[2]	AV18	DDR3	O
SB_MA[3]	AU17	DDR3	O
SB_MA[4]	AY18	DDR3	O
SB_MA[5]	AV17	DDR3	O
SB_MA[6]	AW17	DDR3	O
SB_MA[7]	AU16	DDR3	O
SB_MA[8]	AT17	DDR3	O
SB_MA[9]	AY16	DDR3	O
SB_ODT[0]	AU27	DDR3	O
SB_ODT[1]	AU29	DDR3	O
SB_ODT[2]	AV27	DDR3	O
SB_ODT[3]	AU28	DDR3	O
SB_RAS#	AW26	DDR3	O
SB_WE#	AU26	DDR3	O
SKTOCC#	AK38		O
SM_DRAMPWROK	AH37	Asynch CMOS	I
SM_DRAMRST#	AV8	DDR3	O
SM_RCOMP[0]	AG1	Analog	I
SM_RCOMP[1]	AD1	Analog	I
SM_RCOMP[2]	AE1	Analog	I
TAPPWRGOOD	AK34	Asynch CMOS	O
TCK	AN37	TAP	I
TDI	AM37	TAP	I
TDI_M	AF37	TAP	I
TDO	AM38	TAP	O
TDO_M	AF38	TAP	O
THERMTRIP#	AF35	Asynch GTL	O
TMS	AN40	TAP	I
TRST#	AM39	TAP	I
VAXG	A14	PWR	



Table 8-2. Processor Pin List by Pin Name

Pin Name	Pin #	Buffer Type	Dir.
VAXG	A15	PWR	
VAXG	A17	PWR	
VAXG	A18	PWR	
VAXG	B14	PWR	
VAXG	B15	PWR	
VAXG	B17	PWR	
VAXG	B18	PWR	
VAXG	C14	PWR	
VAXG	C15	PWR	
VAXG	C17	PWR	
VAXG	C18	PWR	
VAXG	C20	PWR	
VAXG	C21	PWR	
VAXG	D14	PWR	
VAXG	D15	PWR	
VAXG	D17	PWR	
VAXG	D18	PWR	
VAXG	D20	PWR	
VAXG	D21	PWR	
VAXG	E14	PWR	
VAXG	E15	PWR	
VAXG	E17	PWR	
VAXG	E18	PWR	
VAXG	E20	PWR	
VAXG	F14	PWR	
VAXG	F15	PWR	
VAXG	F17	PWR	
VAXG	F18	PWR	
VAXG	F19	PWR	
VAXG	G14	PWR	
VAXG	G15	PWR	
VAXG	G17	PWR	
VAXG	G18	PWR	
VAXG	H14	PWR	
VAXG	H15	PWR	
VAXG	H17	PWR	
VAXG	J14	PWR	
VAXG	J15	PWR	
VAXG	J16	PWR	
VAXG	K14	PWR	
VAXG	K15	PWR	
VAXG	K16	PWR	
VAXG	L14	PWR	
VAXG	L15	PWR	

Table 8-2. Processor Pin List by Pin Name

Pin Name	Pin #	Buffer Type	Dir.
VAXG	L16	PWR	
VAXG	M14	PWR	
VAXG	M15	PWR	
VAXG	M16	PWR	
VAXG_SENSE	A13	Analog	
VCC	A23	PWR	
VCC	A24	PWR	
VCC	A26	PWR	
VCC	A27	PWR	
VCC	A33	PWR	
VCC	A35	PWR	
VCC	A36	PWR	
VCC	B23	PWR	
VCC	B25	PWR	
VCC	B26	PWR	
VCC	B28	PWR	
VCC	B29	PWR	
VCC	B31	PWR	
VCC	B32	PWR	
VCC	B34	PWR	
VCC	B35	PWR	
VCC	B37	PWR	
VCC	B38	PWR	
VCC	C23	PWR	
VCC	C24	PWR	
VCC	C25	PWR	
VCC	C27	PWR	
VCC	C28	PWR	
VCC	C30	PWR	
VCC	C31	PWR	
VCC	C33	PWR	
VCC	C34	PWR	
VCC	C36	PWR	
VCC	C37	PWR	
VCC	C39	PWR	
VCC	D23	PWR	
VCC	D24	PWR	
VCC	D26	PWR	
VCC	D27	PWR	
VCC	D29	PWR	
VCC	D30	PWR	
VCC	D32	PWR	
VCC	D33	PWR	
VCC	D35	PWR	

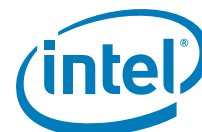

Table 8-2. Processor Pin List by Pin Name

Pin Name	Pin #	Buffer Type	Dir.
VCC	D36	PWR	
VCC	D38	PWR	
VCC	D39	PWR	
VCC	E22	PWR	
VCC	E23	PWR	
VCC	E25	PWR	
VCC	E26	PWR	
VCC	E28	PWR	
VCC	E29	PWR	
VCC	E31	PWR	
VCC	E32	PWR	
VCC	E34	PWR	
VCC	E35	PWR	
VCC	E37	PWR	
VCC	E38	PWR	
VCC	E40	PWR	
VCC	F21	PWR	
VCC	F22	PWR	
VCC	F24	PWR	
VCC	F25	PWR	
VCC	F27	PWR	
VCC	F28	PWR	
VCC	F30	PWR	
VCC	F31	PWR	
VCC	F33	PWR	
VCC	F34	PWR	
VCC	F36	PWR	
VCC	F37	PWR	
VCC	F39	PWR	
VCC	F40	PWR	
VCC	G20	PWR	
VCC	G21	PWR	
VCC	G23	PWR	
VCC	G24	PWR	
VCC	G26	PWR	
VCC	G27	PWR	
VCC	G29	PWR	
VCC	G30	PWR	
VCC	G32	PWR	
VCC	G33	PWR	
VCC	G35	PWR	
VCC	G36	PWR	
VCC	G38	PWR	
VCC	G39	PWR	

Table 8-2. Processor Pin List by Pin Name

Pin Name	Pin #	Buffer Type	Dir.
VCC	H19	PWR	
VCC	H20	PWR	
VCC	H22	PWR	
VCC	H23	PWR	
VCC	H25	PWR	
VCC	H26	PWR	
VCC	H28	PWR	
VCC	H29	PWR	
VCC	H31	PWR	
VCC	H32	PWR	
VCC	H34	PWR	
VCC	H35	PWR	
VCC	H37	PWR	
VCC	H38	PWR	
VCC	H40	PWR	
VCC	J18	PWR	
VCC	J19	PWR	
VCC	J21	PWR	
VCC	J22	PWR	
VCC	J24	PWR	
VCC	J25	PWR	
VCC	J27	PWR	
VCC	J28	PWR	
VCC	J30	PWR	
VCC	J31	PWR	
VCC	J33	PWR	
VCC	J34	PWR	
VCC	J36	PWR	
VCC	J37	PWR	
VCC	J39	PWR	
VCC	J40	PWR	
VCC	K17	PWR	
VCC	K18	PWR	
VCC	K20	PWR	
VCC	K21	PWR	
VCC	K23	PWR	
VCC	K24	PWR	
VCC	K26	PWR	
VCC	K27	PWR	
VCC	K29	PWR	
VCC	K30	PWR	
VCC	K32	PWR	
VCC	K33	PWR	
VCC	K35	PWR	



Table 8-2. Processor Pin List by Pin Name

Pin Name	Pin #	Buffer Type	Dir.
VCC	K36	PWR	
VCC	K38	PWR	
VCC	K39	PWR	
VCC	L17	PWR	
VCC	L19	PWR	
VCC	L20	PWR	
VCC	L22	PWR	
VCC	L23	PWR	
VCC	L25	PWR	
VCC	L26	PWR	
VCC	L28	PWR	
VCC	L29	PWR	
VCC	L31	PWR	
VCC	L32	PWR	
VCC	L34	PWR	
VCC	L35	PWR	
VCC	L37	PWR	
VCC	L38	PWR	
VCC	L40	PWR	
VCC	M17	PWR	
VCC	M19	PWR	
VCC	M21	PWR	
VCC	M22	PWR	
VCC	M24	PWR	
VCC	M25	PWR	
VCC	M27	PWR	
VCC	M28	PWR	
VCC	M30	PWR	
VCC	M33	PWR	
VCC	M34	PWR	
VCC	M36	PWR	
VCC	M37	PWR	
VCC	M39	PWR	
VCC	M40	PWR	
VCC	N33	PWR	
VCC	N35	PWR	
VCC	N36	PWR	
VCC	N38	PWR	
VCC	N39	PWR	
VCC	P33	PWR	
VCC	P34	PWR	
VCC	P35	PWR	
VCC	P36	PWR	
VCC	P37	PWR	

Table 8-2. Processor Pin List by Pin Name

Pin Name	Pin #	Buffer Type	Dir.
VCC	P38	PWR	
VCC	P39	PWR	
VCC	P40	PWR	
VCC	R33	PWR	
VCC	R34	PWR	
VCC	R35	PWR	
VCC	R36	PWR	
VCC	R37	PWR	
VCC	R38	PWR	
VCC	R39	PWR	
VCC	R40	PWR	
VCC_NCTF	A38	PWR	
VCC_NCTF	C40	PWR	
VCC_SENSE	T35	Analog	
VCCPLL	AF7	PWR	
VCCPLL	AF8	PWR	
VCCPLL	AG8	PWR	
VCCPWGOOD_0	AH35	Asynch	I
VCCPWGOOD_1	AH36	Asynch	I
VDDQ	AJ11	PWR	
VDDQ	AJ13	PWR	
VDDQ	AJ15	PWR	
VDDQ	AT10	PWR	
VDDQ	AT18	PWR	
VDDQ	AT21	PWR	
VDDQ	AU11	PWR	
VDDQ	AV13	PWR	
VDDQ	AV16	PWR	
VDDQ	AV19	PWR	
VDDQ	AV22	PWR	
VDDQ	AV25	PWR	
VDDQ	AV28	PWR	
VDDQ	AW9	PWR	
VDDQ	AY11	PWR	
VDDQ	AY14	PWR	
VDDQ	AY17	PWR	
VDDQ	AY23	PWR	
VDDQ	AY26	PWR	
VID[0]/MSID[0]	U40	CMOS	I/O
VID[1]/MSID[1]	U39	CMOS	I/O
VID[2]/MSID[2]	U38	CMOS	I/O
VID[3]/CSC[0]	U37	CMOS	I/O
VID[4]/CSC[1]	U36	CMOS	I/O
VID[5]/CSC[2]	U35	CMOS	I/O

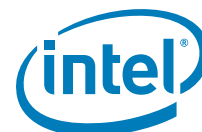

Table 8-2. Processor Pin List by Pin Name

Pin Name	Pin #	Buffer Type	Dir.
VID[6]	U34	CMOS	I/O
VID[7]	U33	CMOS	I/O
VSS	A16	GND	
VSS	A25	GND	
VSS	A28	GND	
VSS	A34	GND	
VSS	A37	GND	
VSS	AA5	GND	
VSS	AB3	GND	
VSS	AB33	GND	
VSS	AB34	GND	
VSS	AB35	GND	
VSS	AB36	GND	
VSS	AB37	GND	
VSS	AB38	GND	
VSS	AB39	GND	
VSS	AB40	GND	
VSS	AB6	GND	
VSS	AB8	GND	
VSS	AC1	GND	
VSS	AD5	GND	
VSS	AD8	GND	
VSS	AE3	GND	
VSS	AE37	GND	
VSS	AE7	GND	
VSS	AF1	GND	
VSS	AF40	GND	
VSS	AF6	GND	
VSS	AG34	GND	
VSS	AG36	GND	
VSS	AG7	GND	
VSS	AH3	GND	
VSS	AH33	GND	
VSS	AH38	GND	
VSS	AH5	GND	
VSS	AJ1	GND	
VSS	AJ12	GND	
VSS	AJ14	GND	
VSS	AJ16	GND	
VSS	AJ18	GND	
VSS	AJ20	GND	
VSS	AJ22	GND	
VSS	AJ24	GND	
VSS	AJ26	GND	

Table 8-2. Processor Pin List by Pin Name

Pin Name	Pin #	Buffer Type	Dir.
VSS	AJ28	GND	
VSS	AJ30	GND	
VSS	AJ33	GND	
VSS	AJ34	GND	
VSS	AJ40	GND	
VSS	AJ6	GND	
VSS	AJ9	GND	
VSS	AK10	GND	
VSS	AK17	GND	
VSS	AK36	GND	
VSS	AK4	GND	
VSS	AK5	GND	
VSS	AK8	GND	
VSS	AL11	GND	
VSS	AL13	GND	
VSS	AL16	GND	
VSS	AL19	GND	
VSS	AL22	GND	
VSS	AL25	GND	
VSS	AL28	GND	
VSS	AL3	GND	
VSS	AL31	GND	
VSS	AL34	GND	
VSS	AL38	GND	
VSS	AL7	GND	
VSS	AM1	GND	
VSS	AM40	GND	
VSS	AM5	GND	
VSS	AM9	GND	
VSS	AN13	GND	
VSS	AN20	GND	
VSS	AN22	GND	
VSS	AN25	GND	
VSS	AN28	GND	
VSS	AN31	GND	
VSS	AN36	GND	
VSS	AN4	GND	
VSS	AN9	GND	
VSS	AP12	GND	
VSS	AP15	GND	
VSS	AP16	GND	
VSS	AP17	GND	
VSS	AP20	GND	
VSS	AP24	GND	



Table 8-2. Processor Pin List by Pin Name

Pin Name	Pin #	Buffer Type	Dir.
VSS	AP26	GND	
VSS	AP27	GND	
VSS	AP29	GND	
VSS	AP33	GND	
VSS	AP35	GND	
VSS	AP38	GND	
VSS	AP4	GND	
VSS	AP7	GND	
VSS	AP9	GND	
VSS	AR1	GND	
VSS	AR20	GND	
VSS	AR23	GND	
VSS	AR30	GND	
VSS	AR40	GND	
VSS	AT12	GND	
VSS	AT14	GND	
VSS	AT16	GND	
VSS	AT2	GND	
VSS	AT24	GND	
VSS	AT27	GND	
VSS	AT30	GND	
VSS	AT34	GND	
VSS	AT37	GND	
VSS	AT5	GND	
VSS	AT8	GND	
VSS	AU32	GND	
VSS	AU36	GND	
VSS	AU6	GND	
VSS	AU7	GND	
VSS	AV3	GND	
VSS	AV31	GND	
VSS	AV34	GND	
VSS	AV38	GND	
VSS	AY33	GND	
VSS	AY36	GND	
VSS	AY4	GND	
VSS	AY7	GND	
VSS	B16	GND	
VSS	B24	GND	
VSS	B27	GND	
VSS	B30	GND	
VSS	B33	GND	
VSS	B36	GND	
VSS	B7	GND	

Table 8-2. Processor Pin List by Pin Name

Pin Name	Pin #	Buffer Type	Dir.
VSS	B9	GND	
VSS	C13	GND	
VSS	C16	GND	
VSS	C19	GND	
VSS	C22	GND	
VSS	C26	GND	
VSS	C29	GND	
VSS	C32	GND	
VSS	C35	GND	
VSS	C38	GND	
VSS	C5	GND	
VSS	D10	GND	
VSS	D12	GND	
VSS	D13	GND	
VSS	D16	GND	
VSS	D19	GND	
VSS	D22	GND	
VSS	D25	GND	
VSS	D28	GND	
VSS	D31	GND	
VSS	D34	GND	
VSS	D37	GND	
VSS	D4	GND	
VSS	D40	GND	
VSS	D5	GND	
VSS	D6	GND	
VSS	D8	GND	
VSS	E13	GND	
VSS	E16	GND	
VSS	E19	GND	
VSS	E21	GND	
VSS	E24	GND	
VSS	E27	GND	
VSS	E3	GND	
VSS	E30	GND	
VSS	E33	GND	
VSS	E36	GND	
VSS	E39	GND	
VSS	E4	GND	
VSS	F11	GND	
VSS	F13	GND	
VSS	F16	GND	
VSS	F2	GND	
VSS	F20	GND	

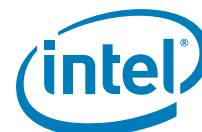

Table 8-2. Processor Pin List by Pin Name

Pin Name	Pin #	Buffer Type	Dir.
VSS	F23	GND	
VSS	F26	GND	
VSS	F29	GND	
VSS	F32	GND	
VSS	F35	GND	
VSS	F38	GND	
VSS	F8	GND	
VSS	G13	GND	
VSS	G16	GND	
VSS	G19	GND	
VSS	G22	GND	
VSS	G25	GND	
VSS	G28	GND	
VSS	G31	GND	
VSS	G34	GND	
VSS	G37	GND	
VSS	G4	GND	
VSS	G40	GND	
VSS	G9	GND	
VSS	H11	GND	
VSS	H13	GND	
VSS	H16	GND	
VSS	H18	GND	
VSS	H2	GND	
VSS	H21	GND	
VSS	H24	GND	
VSS	H27	GND	
VSS	H30	GND	
VSS	H33	GND	
VSS	H36	GND	
VSS	H39	GND	
VSS	H5	GND	
VSS	H6	GND	
VSS	J13	GND	
VSS	J17	GND	
VSS	J20	GND	
VSS	J23	GND	
VSS	J26	GND	
VSS	J29	GND	
VSS	J32	GND	
VSS	J35	GND	
VSS	J38	GND	
VSS	J4	GND	
VSS	J7	GND	

Table 8-2. Processor Pin List by Pin Name

Pin Name	Pin #	Buffer Type	Dir.
VSS	J9	GND	
VSS	K11	GND	
VSS	K13	GND	
VSS	K19	GND	
VSS	K2	GND	
VSS	K22	GND	
VSS	K25	GND	
VSS	K28	GND	
VSS	K31	GND	
VSS	K34	GND	
VSS	K37	GND	
VSS	K40	GND	
VSS	K5	GND	
VSS	K6	GND	
VSS	L13	GND	
VSS	L18	GND	
VSS	L21	GND	
VSS	L24	GND	
VSS	L27	GND	
VSS	L30	GND	
VSS	L33	GND	
VSS	L36	GND	
VSS	L39	GND	
VSS	L4	GND	
VSS	L9	GND	
VSS	M13	GND	
VSS	M18	GND	
VSS	M2	GND	
VSS	M20	GND	
VSS	M23	GND	
VSS	M26	GND	
VSS	M29	GND	
VSS	M32	GND	
VSS	M35	GND	
VSS	M38	GND	
VSS	M5	GND	
VSS	M6	GND	
VSS	M7	GND	
VSS	N34	GND	
VSS	N37	GND	
VSS	N4	GND	
VSS	N40	GND	
VSS	P2	GND	
VSS	P5	GND	

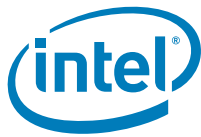

Table 8-2. Processor Pin List by Pin Name

Pin Name	Pin #	Buffer Type	Dir.
VSS	R4	GND	
VSS	T33	GND	
VSS	T36	GND	
VSS	T37	GND	
VSS	T38	GND	
VSS	T39	GND	
VSS	T5	GND	
VSS	U4	GND	
VSS	V5	GND	
VSS	W33	GND	
VSS	W34	GND	
VSS	W35	GND	
VSS	W36	GND	
VSS	W37	GND	
VSS	W38	GND	
VSS	Y7	GND	
VSS_SENSE	T34	Analog	
VSS_SENSE_VTT	AE36	Analog	
VSSAXG_SENSE	B13	Analog	
VTT	AA33	PWR	
VTT	AA34	PWR	
VTT	AA35	PWR	
VTT	AA36	PWR	
VTT	AA37	PWR	
VTT	AA38	PWR	
VTT	AB7	PWR	
VTT	AC33	PWR	
VTT	AC34	PWR	
VTT	AC35	PWR	
VTT	AC36	PWR	
VTT	AC37	PWR	
VTT	AC38	PWR	
VTT	AC39	PWR	
VTT	AC40	PWR	
VTT	AC5	PWR	
VTT	AC8	PWR	
VTT	AD33	PWR	
VTT	AD34	PWR	
VTT	AD35	PWR	
VTT	AD36	PWR	
VTT	AD37	PWR	
VTT	AD38	PWR	
VTT	AD39	PWR	
VTT	AD40	PWR	

Table 8-2. Processor Pin List by Pin Name

Pin Name	Pin #	Buffer Type	Dir.
VTT	AE33	PWR	
VTT	AE34	PWR	
VTT	AE39	PWR	
VTT	AE40	PWR	
VTT	AE8	PWR	
VTT	AF33	PWR	
VTT	AG33	PWR	
VTT	AJ17	PWR	
VTT	AJ19	PWR	
VTT	AJ21	PWR	
VTT	AJ23	PWR	
VTT	AJ25	PWR	
VTT	AJ27	PWR	
VTT	AJ29	PWR	
VTT	AJ31	PWR	
VTT	AJ32	PWR	
VTT	AK19	PWR	
VTT	AK20	PWR	
VTT	AK21	PWR	
VTT	AL20	PWR	
VTT	AL21	PWR	
VTT	L10	PWR	
VTT	M10	PWR	
VTT	M11	PWR	
VTT	M9	PWR	
VTT	N7	PWR	
VTT	P6	PWR	
VTT	P7	PWR	
VTT	P8	PWR	
VTT	T2	PWR	
VTT	T6	PWR	
VTT	T7	PWR	
VTT	T8	PWR	
VTT	V2	PWR	
VTT	V33	PWR	
VTT	V34	PWR	
VTT	V35	PWR	
VTT	V36	PWR	
VTT	V37	PWR	
VTT	V38	PWR	
VTT	V39	PWR	
VTT	V40	PWR	
VTT	V6	PWR	
VTT	V7	PWR	

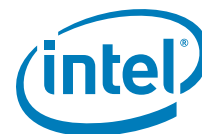

Table 8-2. Processor Pin List by Pin Name

Pin Name	Pin #	Buffer Type	Dir.
VTT	V8	PWR	
VTT	W1	PWR	
VTT	W6	PWR	
VTT	Y33	PWR	
VTT	Y34	PWR	
VTT	Y35	PWR	
VTT	Y36	PWR	
VTT	Y37	PWR	
VTT	Y38	PWR	
VTT_SELECT	AF39	CMOS	O
VTT_SENSE	AE35	Analog	
VTT_PWRGOOD	AG37	Asynch CMOS	I

§ §



Mouser Electronics

Authorized Distributor

Click to View Pricing, Inventory, Delivery & Lifecycle Information:

[Intel:](#)

[BV80605001911APS LBLC](#)