

(Units : mm)

• TO252-3

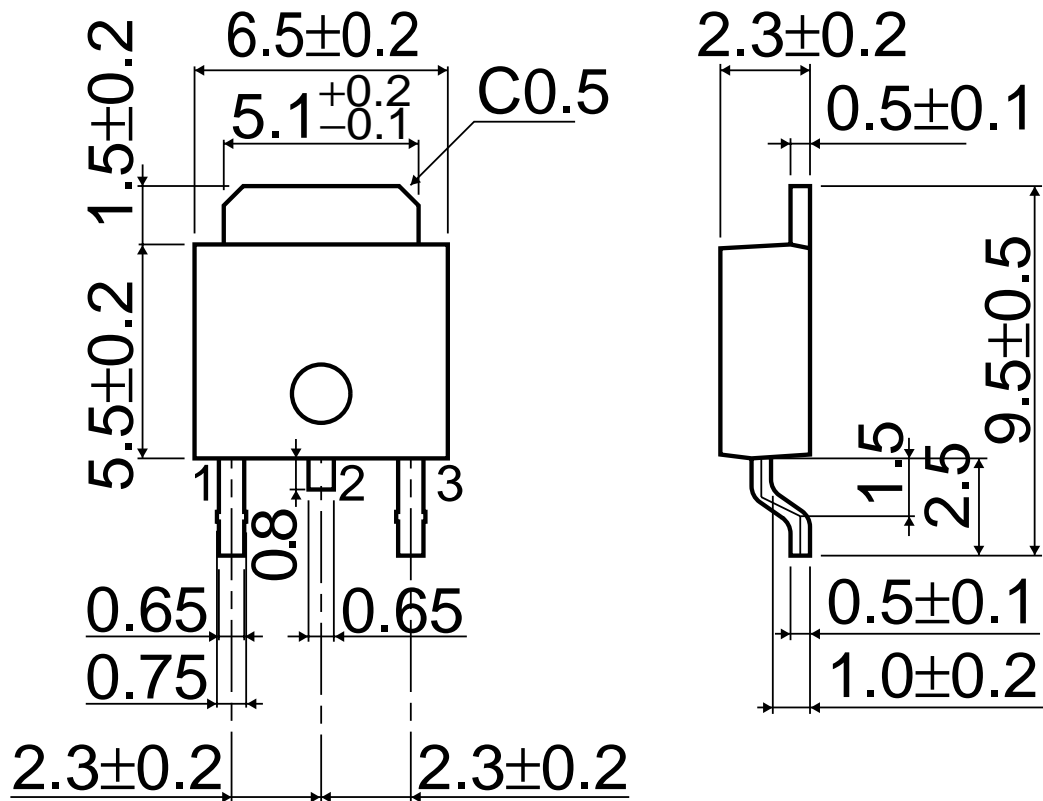

* The contents described herein are subject to change without notice.