

(Units : mm)

# • SOP28

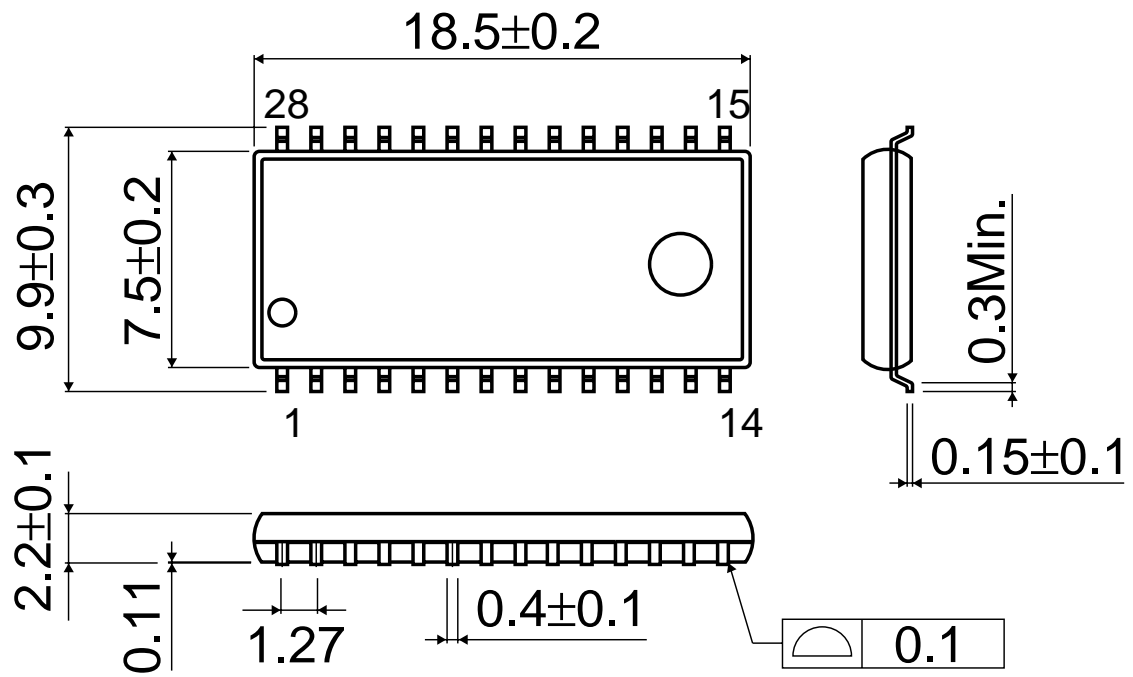

\* The contents described herein are subject to change without notice.