

(Units : mm)

• SDIP30

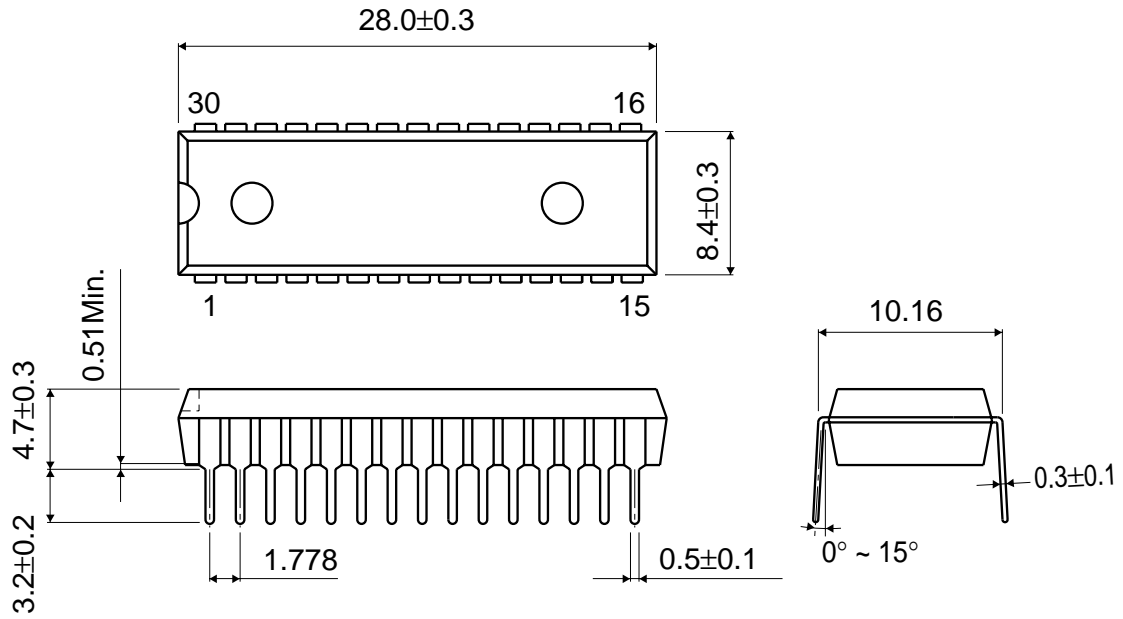

* The contents described herein are subject to change without notice.