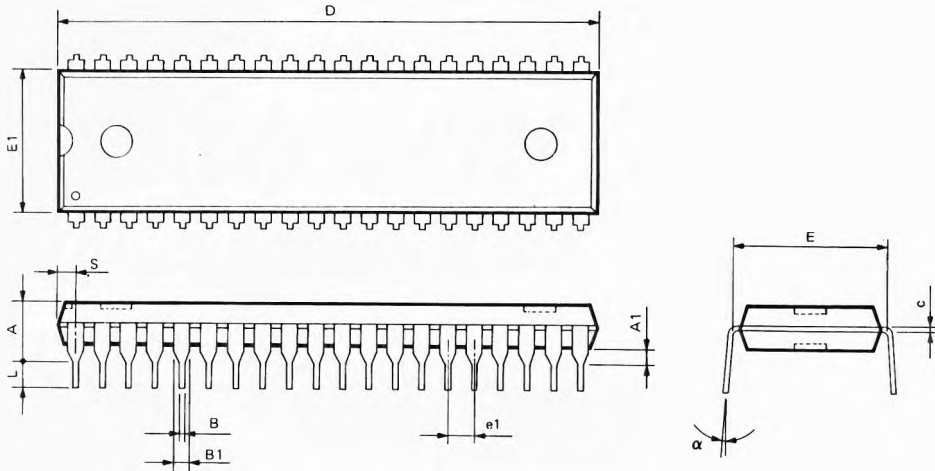

P-DIP 40L Outline Dimension

Symbol	Dimensions in inch	Dimensions in mm
A	0.210 Max.	5.334 Max.
A1	0.010 Min.	0.254 Min.
B	0.018 + 0.004 - 0.002	0.457 + 0.102 - 0.051
B1	0.050 + 0.004 - 0.002	1.270 + 0.102 - 0.051
c	0.010 + 0.004 - 0.002	0.254 + 0.102 - 0.051
D	2.055 (2.070 Max.)	52.197 (52.578 Max.)
E	0.600 ± 0.010	15.240 ± 0.254
E1	0.550 (0.575 Max.)	13.970 (14.605 Max.)
e1	0.100 ± 0.010	2.540 ± 0.254
L	0.130 ± 0.010	3.302 ± 0.254
α	0° ~ 15°	0° ~ 15°
S	0.090 Max.	2.286 Max.