

### FAST SOFT RECOVERY RECTIFIER DIODE

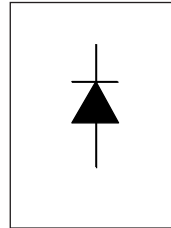

$$V_F < 1.33V @ 10A$$

$$t_{rr} = 80ns$$

$$V_{RRM} 1000 \text{ to } 1200V$$

#### Description/Features

The 10ETF.. fast soft recovery QUIETIR rectifier series has been optimized for combined short reverse recovery time and low forward voltage drop.

The glass passivation ensures stable reliable operation in the most severe temperature and power cycling conditions.

Typical applications are both:

- output rectification and freewheeling in inverters, choppers and converters
- and input rectifications where severe restrictions on conducted EMI should be met.

#### Major Ratings and Characteristics

Characteristics	10ETF..	Units
$I_{F(AV)}$ Sinusoidal waveform	10	A
$V_{RRM}$	1000 to 1200	V
$I_{FSM}$	160	A
$V_F$ @ 10A, $T_J = 25^\circ C$	1.33	V
$t_{rr}$ @ 1A, 100A/ $\mu s$	80	ns
$T_J$	-40 to 150	$^\circ C$

#### Package Outline

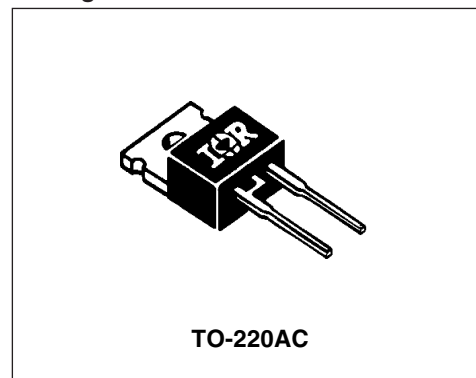

Voltage Ratings

Part Number	$V_{RRM}$ , maximum peak reverse voltage V	$V_{RSM}$ , maximum non repetitive peak reverse voltage V	$I_{RRM}$ 150°C mA
10ETF10	1000	1100	4
10ETF12	1200	1300	

Absolute Maximum Ratings

Parameters	10ETF..	Units	Conditions
$I_{F(AV)}$ Max. Average Forward Current	10	A	@ $T_C = 125^\circ\text{C}$ , 180° conduction half sine wave
$I_{FSM}$ Max. Peak One Cycle Non-Repetitive Surge Current	160	A	10ms Sine pulse, rated $V_{RRM}$ applied
	185		10ms Sine pulse, no voltage reapplied
$I^2t$ Max. $I^2t$ for fusing	128	$A^2s$	10ms Sine pulse, rated $V_{RRM}$ applied
	180		10ms Sine pulse, no voltage reapplied
$I^2\sqrt{t}$ Max. $I^2\sqrt{t}$ for fusing	1800	$A^2\sqrt{s}$	$t = 0.1$ to 10ms, no voltage reapplied

Electrical Specifications

Parameters	10ETF..	Units	Conditions
$V_{FM}$ Max. Forward Voltage Drop	1.33	V	@ 10A, $T_J = 25^\circ\text{C}$
$r_t$ Forward slope resistance	22.9	$m\Omega$	$T_J = 150^\circ\text{C}$
$V_{F(TO)}$ Threshold voltage	0.96	V	
$I_{RM}$ Max. Reverse Leakage Current	0.1	mA	$T_J = 25^\circ\text{C}$
	4		$T_J = 150^\circ\text{C}$

$V_R = \text{rated } V_{RRM}$

Recovery Characteristics

Parameters	10ETF..	Units	Conditions
$t_{rr}$ Reverse Recovery Time	310	ns	$I_F @ 10\text{Apk}$
$I_{rr}$ Reverse Recovery Current	4.7	A	@ 25A/ $\mu\text{s}$
$Q_{rr}$ Reverse Recovery Charge	1.05	$\mu\text{C}$	@ 25°C
S Typical Snap Factor	0.6		

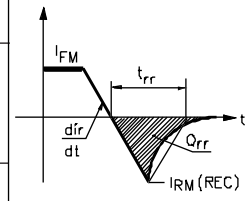

Thermal-Mechanical Specifications

Parameters	10ETF..	Units	Conditions
$T_J$ Max. Junction Temperature Range	-40 to 150	°C	
$T_{stg}$ Max. Storage Temperature Range	-40 to 150	°C	
$R_{thJC}$ Max. Thermal Resistance Junction to Case	1.5	°C/W	DC operation
$R_{thJA}$ Max. Thermal Resistance Junction to Ambient	62	°C/W	
$R_{thCS}$ Typical Thermal Resistance, Case to Heatsink	0.5	°C/W	Mounting surface, smooth and greased
wt Approximate Weight	2 (0.07)	g (oz.)	
T Mounting Torque	Min.	6 (5)	Kg-cm (lbf-in)
	Max.	12 (10)	
Case Style	TO-220AC		JEDEC

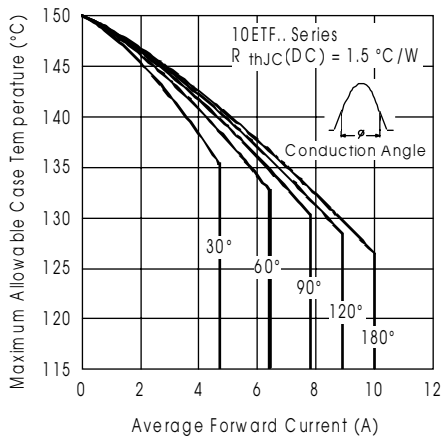

Fig. 1 - Current Rating Characteristics

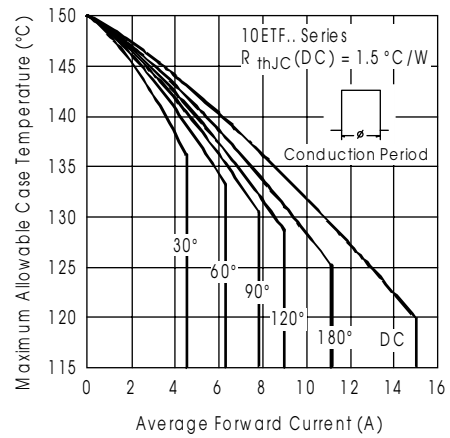

Fig. 2 - Current Rating Characteristics

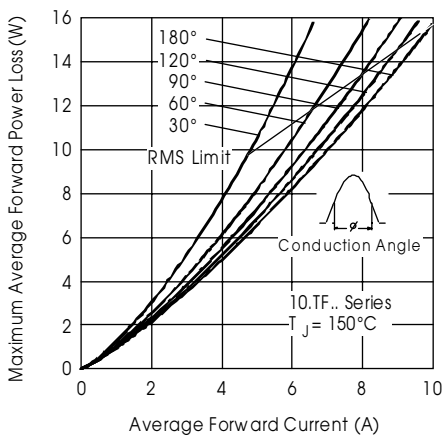

Fig. 3 - Forward Power Loss Characteristics

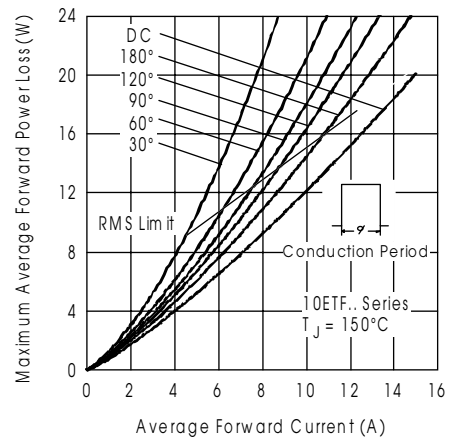

Fig. 4 - Forward Power Loss Characteristics

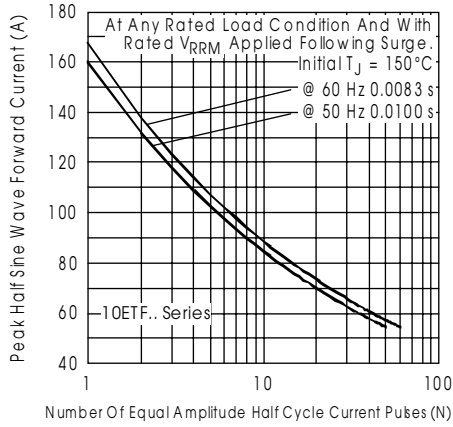

Fig. 5 - Maximum Non-Repetitive Surge Current

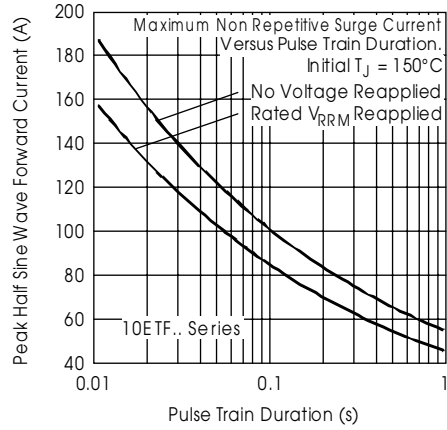

Fig. 6 - Maximum Non-Repetitive Surge Current

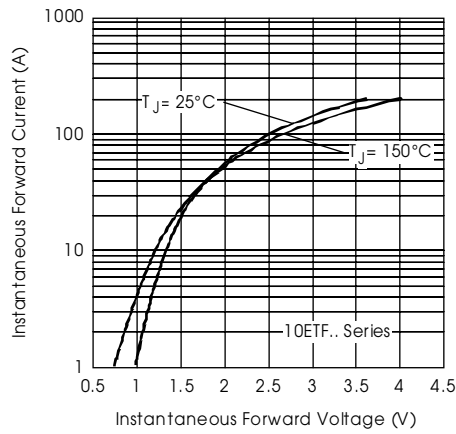

Fig. 7 - Forward Voltage Drop Characteristics

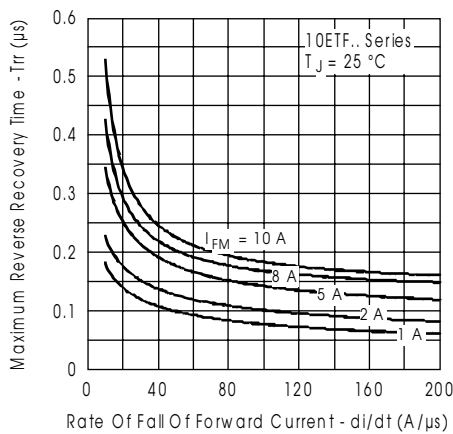

Fig. 8 - Recovery Time Characteristics,  $T_J = 25^\circ\text{C}$

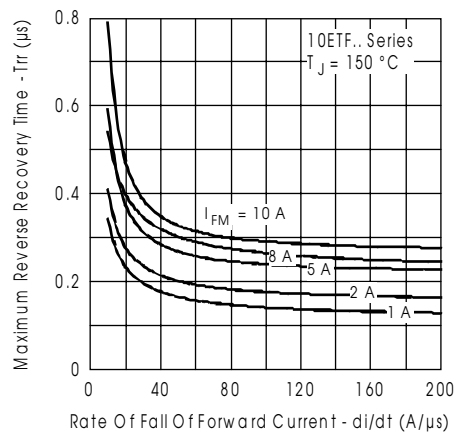

Fig. 9 - Recovery Time Characteristics,  $T_J = 150^\circ\text{C}$

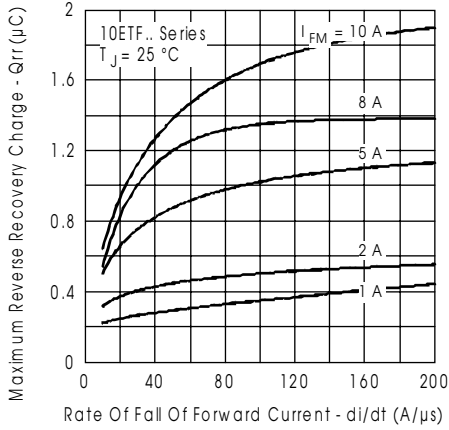

Fig. 10 - Recovery Charge Characteristics,  $T_J = 25^\circ\text{C}$

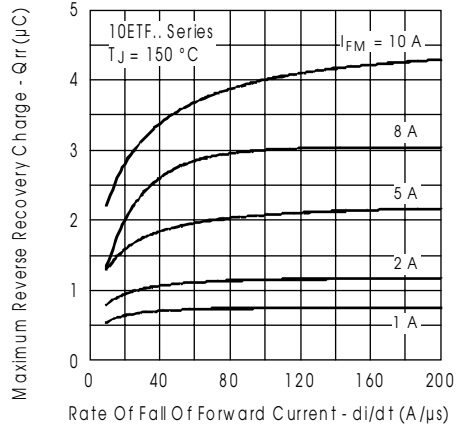

Fig. 11 - Recovery Charge Characteristics,  $T_J = 150^\circ\text{C}$

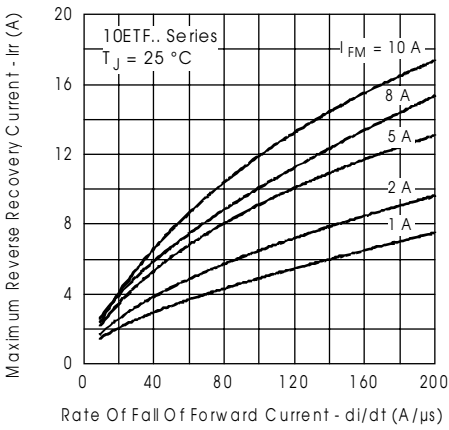

Fig. 12 - Recovery Current Characteristics,  $T_J = 25^\circ\text{C}$

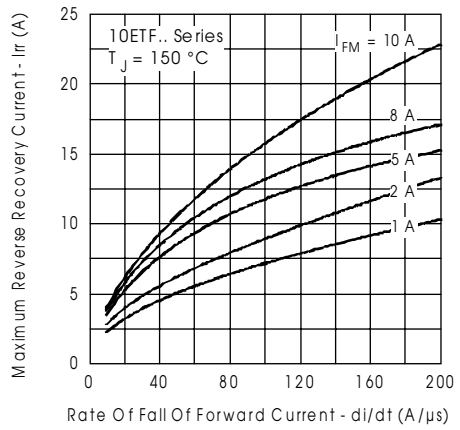

Fig. 13 - Recovery Current Characteristics,  $T_J = 150^\circ\text{C}$

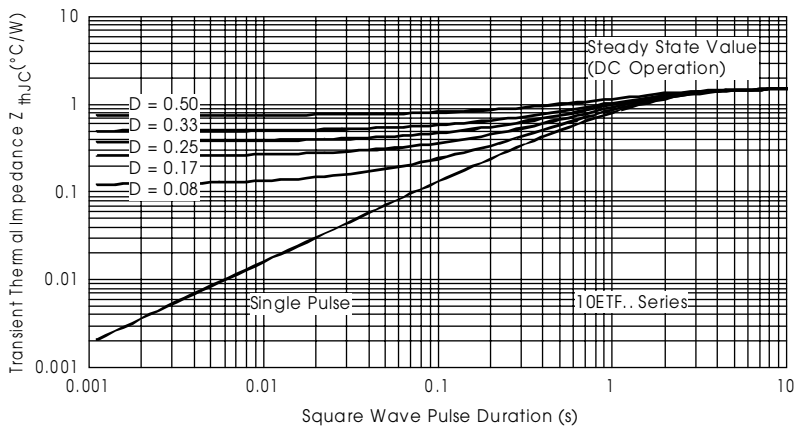
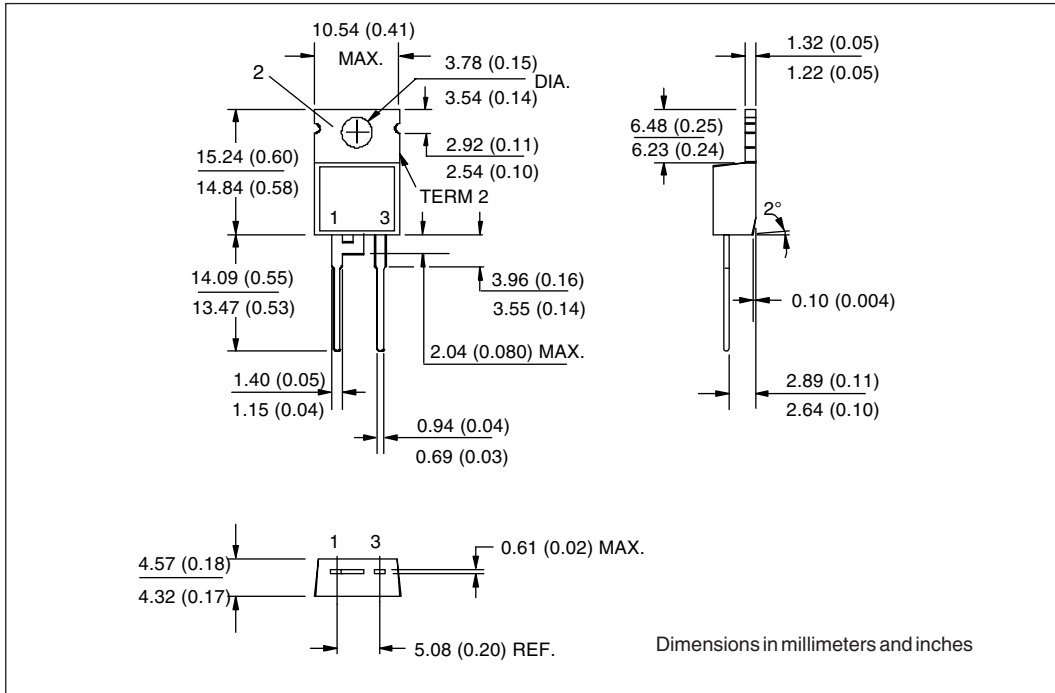
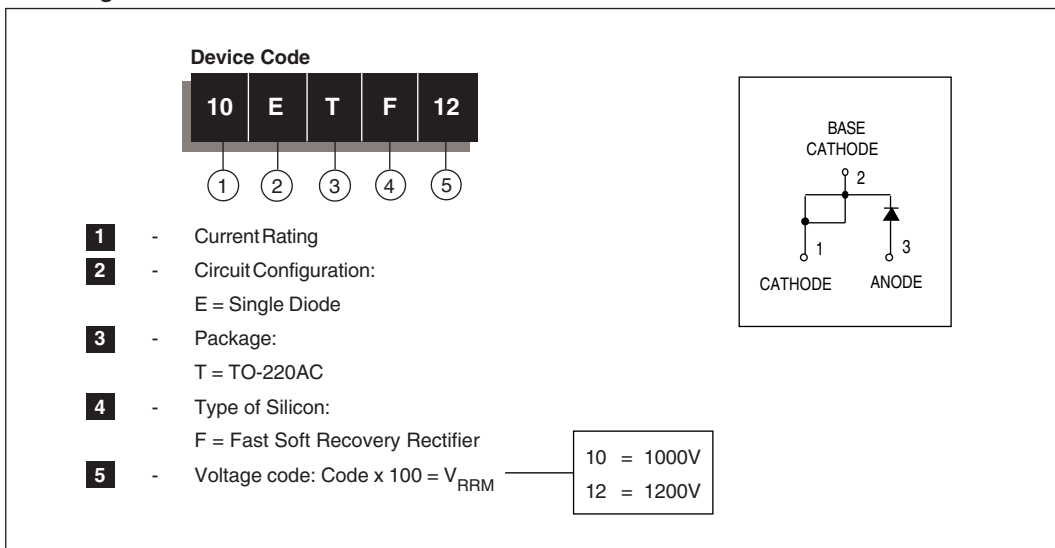

Fig. 14 - Thermal Impedance  $Z_{thJC}$  Characteristics

Outline Table



Ordering Information Table



International  
**IOR** Rectifier

**WORLD HEADQUARTERS:** 233 Kansas St., El Segundo, California 90245 U.S.A. Tel: (310) 322 3331. Fax: (310) 322 3332.  
**EUROPEAN HEADQUARTERS:** Hurst Green, Oxted, Surrey RH8 9BB, U.K. Tel: ++ 44 1883 732020. Fax: ++ 44 1883 733408.  
**IR CANADA:** 15 Lincoln Court, Brampton, Markham, Ontario L6T3Z2. Tel: (905) 453 2200. Fax: (905) 475 8801.  
**IR GERMANY:** Saalburgstrasse 157, 61350 Bad Homburg. Tel: ++ 49 6172 96590. Fax: ++ 49 6172 965933.  
**IR ITALY:** Via Liguria 49, 10071 Borgaro, Torino. Tel: ++ 39 11 4510111. Fax: ++ 39 11 4510220.  
**IR FAR EAST:** K&H Bldg., 2F, 30-4 Nishi-Ikebukuro 3-Chome, Toshima-Ku, Tokyo, Japan 171. Tel: 81 3 3983 0086.  
**IR SOUTHEAST ASIA:** 1 Kim Seng Promenade, Great World City West Tower, 13-11, Singapore 237994. Tel: ++ 65 838 4630.  
**IR TAIWAN:** 16 Fl. Suite D.207, Sec. 2, Tun Haw South Road, Taipei, 10673, Taiwan. Tel: 886 2 2377 9936.