



# 8K × 8 HIGH-SPEED CMOS STATIC RAM

## GENERAL DESCRIPTION

The W2465A is a high-speed, low-power CMOS static RAM organized as 8192 × 8 bits that operates on a single 5-volt power supply. This device is manufactured using Winbond's high performance CMOS technology.

## FEATURES

- High-speed access time: 12/15/20 nS (max.)
- Low-power consumption:
  - Active: 400mW (typ.)
- Single +5V power supply
- Fully static operation
- All inputs and outputs directly TTL compatible
- Three-state outputs
- Available packages: 28-pin 300 mil SOJ and skinny DIP

## PIN CONFIGURATION

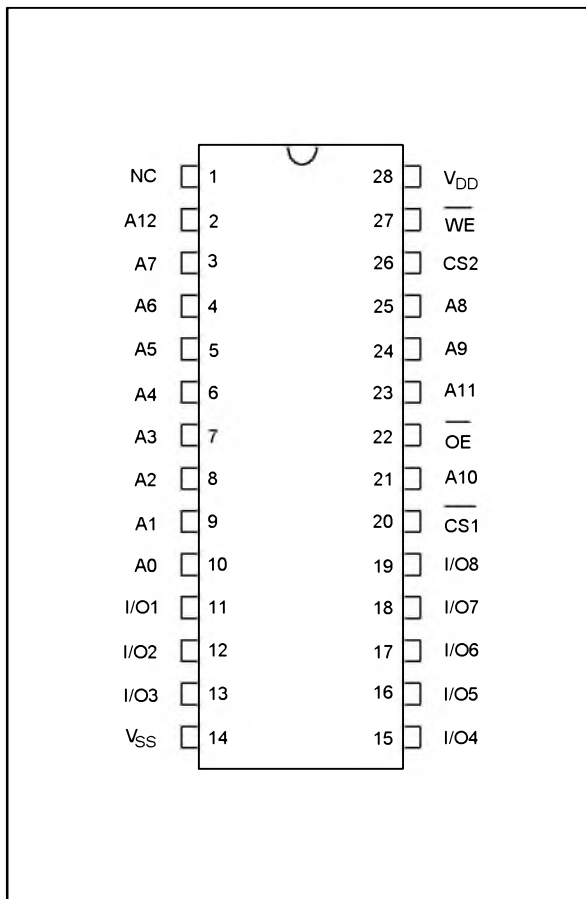

## BLOCK DIAGRAM

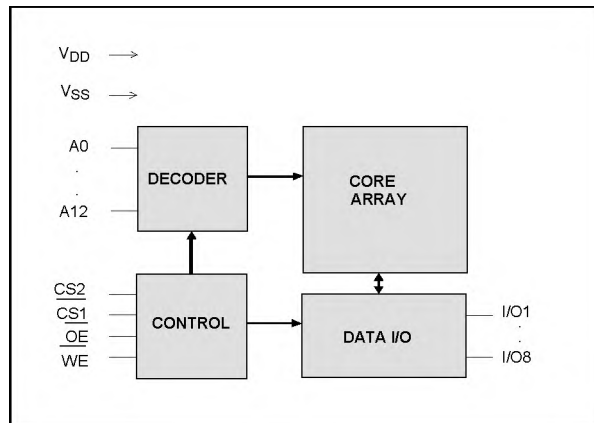

## PIN DESCRIPTION

SYMBOL	DESCRIPTION
A0–A12	Address Inputs
I/O1–I/O8	Data Inputs/Outputs
CS1, CS2	Chip Select Inputs
$\overline{WE}$	Write Enable Input
$\overline{OE}$	Output Enable Input
VDD	Power Supply
VSS	Ground
NC	No Connection



## DC CHARACTERISTICS

### Absolute Maximum Ratings

PARAMETER	RATING	UNIT
Supply Voltage to Vss Potential	-0.5 to +7.0	V
Input/Output to Vss Potential	-0.5 to VDD +0.5	V
Allowable Power Dissipation	1.0	W
Storage Temperature	-65 to +150	°C
Operating Temperature	0 to +70	°C

Note: Exposure to conditions beyond those listed under Absolute Maximum Ratings may adversely affect the life and reliability of the device.

### TRUTH TABLE

CS1	CS2	OE	WE	MODE	I/O1-I/O8	VDD CURRENT
H	X	X	X	Not Selected	High Z	ISB, ISB1
X	L	X	X	Not Selected	High Z	ISB, ISB1
L	H	H	H	Output Disable	High Z	IDD
L	H	L	H	Read	Data Out	IDD
L	H	X	L	Write	Data In	IDD

### OPERATING CHARACTERISTICS

(VDD = 5V ±10%, VSS = 0V, TA = 0 to 70° C)

PARAMETER	SYM.	TEST CONDITIONS	MIN.	TYP.	MAX.	UNIT	
Input Low Voltage	VIL	-	-0.5	-	+0.8	V	
Input High Voltage	VIH	-	+2.2	-	VDD +0.5	V	
Input Leakage Current	ILI	VIN = Vss to VDD	-10	-	+10	μA	
Output Leakage Current	ILO	V/I/O = Vss to VDD, CS1 = VIH or CS2 = VIL or OE = VIH or WE = VIL	-10	-	+10	μA	
Output Low Voltage	VOL	IOL = +8.0 mA	-	-	0.4	V	
Output High Voltage	VOH	IOH = -4.0 mA	2.4	-	-	V	
Operating Power Supply Current	IDD	CS1 = VIL CS2 = VIH I/O = 0 mA Cycle = MIN Duty = 100%	12	-	-	180	mA
			15	-	-	150	mA
			20	-	-	120	mA
Standby Power Supply Current	ISB	CS1 = VIH or CS2 = VIL Cycle = MIN Duty = 100%	-	-	30	mA	
	ISB1	CS1 ≥ VDD -0.2V or CS2 ≤ 0.2V	-	-	5	mA	

Note: Typical characteristics are at VDD = 5V, TA = 25° C.



**CAPACITANCE**

(V<sub>DD</sub> = 5V, T<sub>A</sub> = 25° C, f = 1 MHz)

PARAMETER	SYM.	CONDITIONS	MAX.	UNIT
Input Capacitance	C <sub>IN</sub>	V <sub>IN</sub> = 0V	8	pF
Input/Output Capacitance	C <sub>I/O</sub>	V <sub>OUT</sub> = 0V	10	pF

Note: These parameters are sampled but not 100% tested.

**AC TEST CONDITIONS**

PARAMETER	CONDITIONS
Input Pulse Levels	0V to 3V
Input Rise and Fall Times	5 nS
Input and Output Timing Reference Level	1.5V
Output Load	C <sub>L</sub> = 30 pF, I <sub>OH</sub> /I <sub>OL</sub> = -4 mA/8 mA

**AC TEST LOADS AND WAVEFORM**

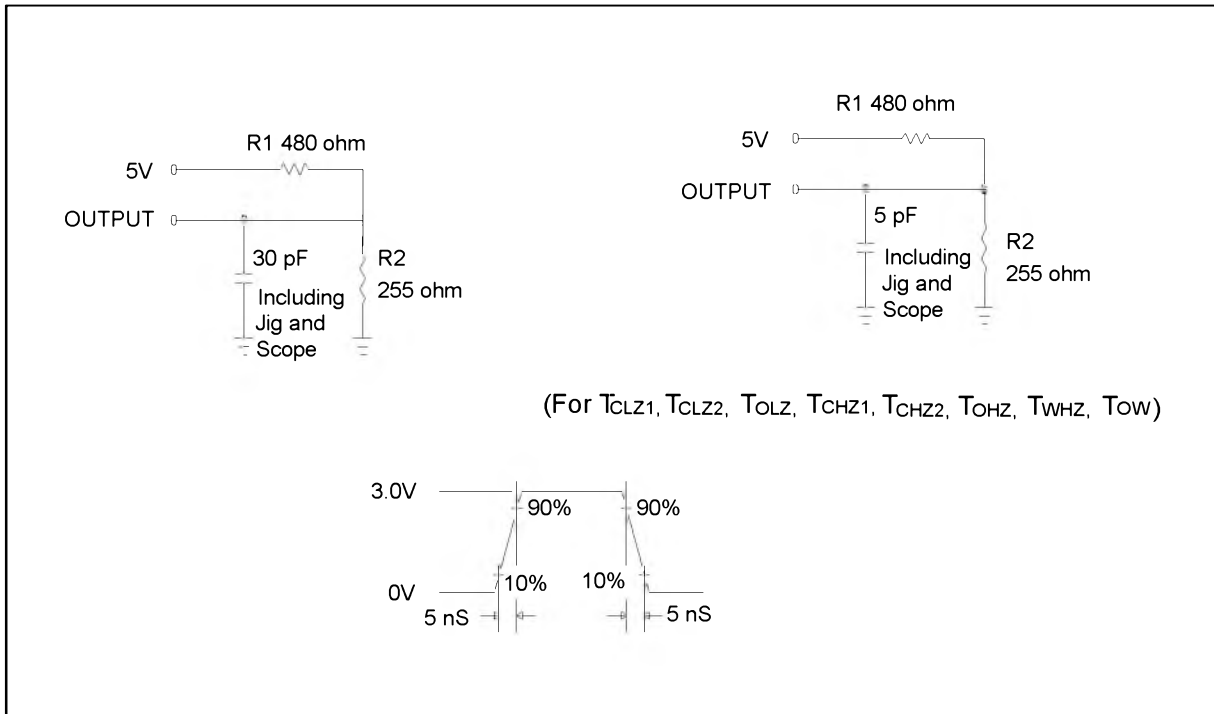



## AC CHARACTERISTICS

(V<sub>DD</sub> = 5V ±10%, V<sub>SS</sub> = 0V, T<sub>A</sub> = 0 to 70° C)

### Read Cycle

PARAMETER		SYM.	W2465A-12		W2465A-15		W2465A-20		UNIT
			MIN.	MAX.	MIN.	MAX.	MIN.	MAX.	
Read Cycle Time		TRC	12	-	15	-	20	-	nS
Address Access Time		TAA	-	12	-	15	-	20	nS
Chip Select Access Time	$\overline{\text{CS1}}$	TACS1	-	12	-	15	-	20	nS
	CS2	TACS2	-	12	-	15	-	20	nS
Output Enable to Output Valid		TAOE	-	6	-	7	-	10	nS
Chip Selection to Output in Low Z	$\overline{\text{CS1}}$	TCLZ1*	3	-	3	-	3	-	nS
	CS2	TCLZ2*	3	-	3	-	3	-	nS
Output Enable to Output in Low Z		TOLZ*	0	-	0	-	0	-	nS
Chip Deselection to Output in High Z	$\overline{\text{CS1}}$	TCHZ1*	-	6	-	7	-	10	nS
	CS2	TCHZ2*	-	6	-	7	-	10	nS
Output Disable to Output in High Z		TOHZ*	-	6	-	7	-	10	nS
Output Hold from Address Change		TOH	3	-	3	-	3	-	nS

\* These parameters are sampled but not 100% tested.

### Write Cycle

PARAMETER		SYM.	W2465A-12		W2465A-15		W2465A-20		UNIT
			MIN.	MAX.	MIN.	MAX.	MIN.	MAX.	
Write Cycle Time		TWC	12	-	15	-	20	-	nS
Chip Selection to End of Write	$\overline{\text{CS1}}$	TcW1	10	-	13	-	17	-	nS
	CS2	TcW2	10	-	13	-	17	-	nS
Address Valid to End of Write		TAW	10	-	13	-	17	-	nS
Address Setup Time		TAS	0	-	0	-	0	-	nS
Write Pulse Width		TWP	10	-	10	-	12	-	nS
Write Recovery Time	$\overline{\text{CS1}}, \overline{\text{WE}}$	TWR1	0	-	0	-	0	-	nS
	CS2	TWR2	0	-	0	-	0	-	nS
Data Valid to End of Write		TDW	7	-	9	-	10	-	nS
Data Hold from End of Write		TDH	0	-	0	-	0	-	nS
Write to Output in High Z		TWHZ*	-	7	-	8	-	10	nS
Output Disable to Output in High Z		TOHZ*	-	7	-	8	-	10	nS
Output Active from End of Write		TOW	0	-	0	-	0	-	nS

\* These parameters are sampled but not 100% tested.

**TIMING WAVEFORMS**

**Read Cycle 1  
(Address Controlled)**

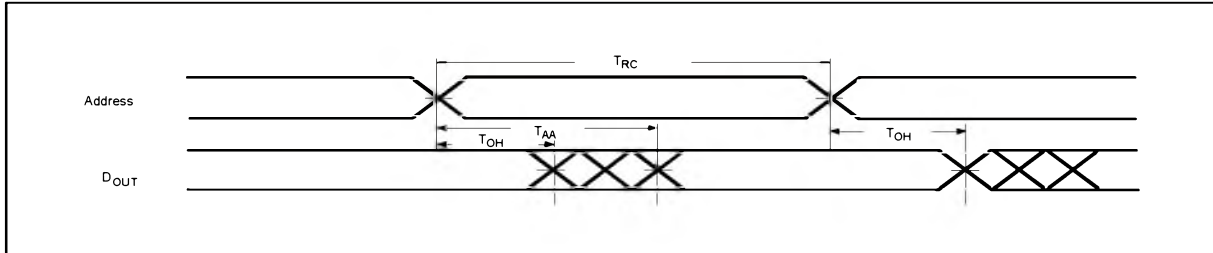

**Read Cycle 2  
(Chip Select Controlled)**

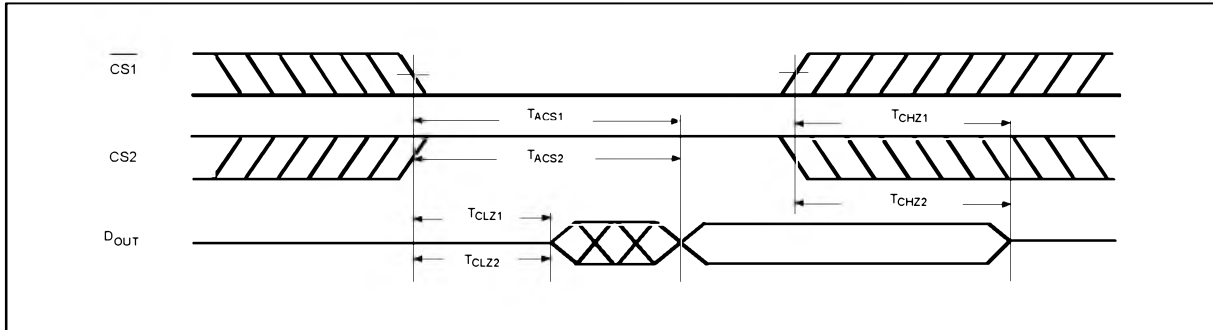

**Read Cycle 3  
(Output Enable Controlled)**

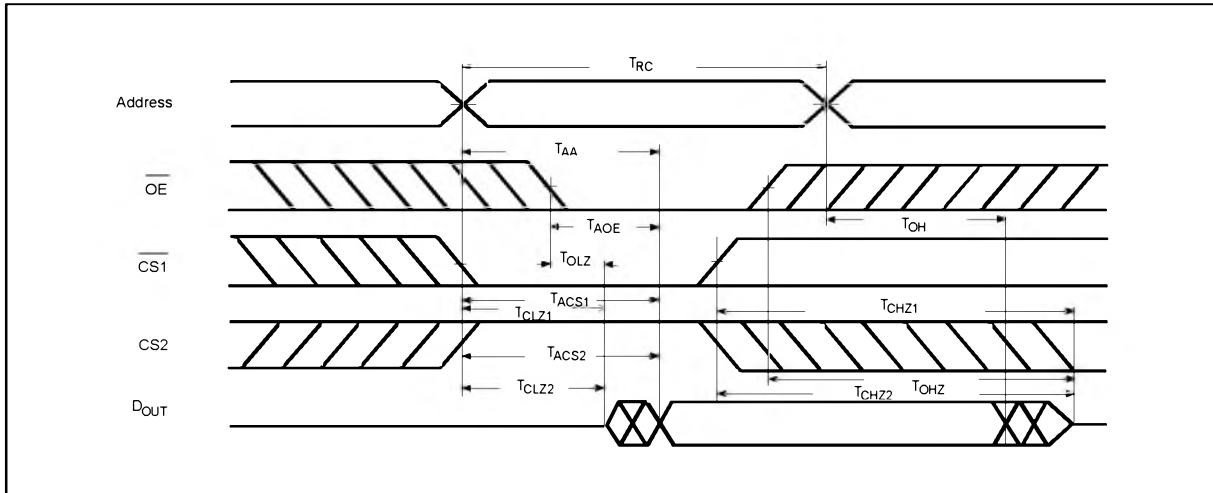



Timing Waveforms, continued

**Write Cycle 1**  
**(OE Clock)**

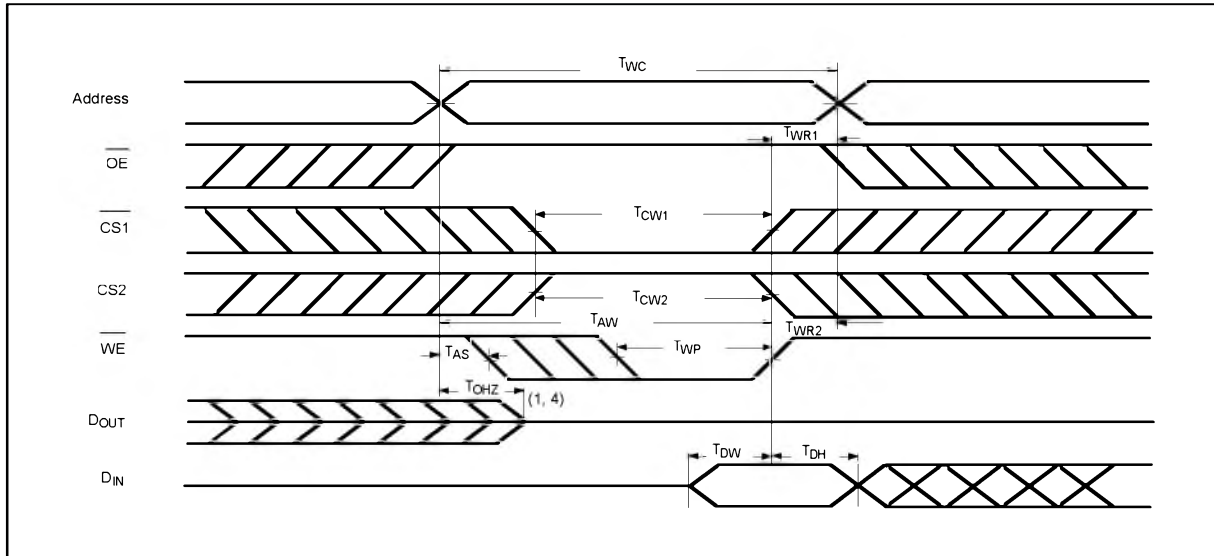

**Write Cycle 2**  
**(OE = VIL Fixed)**

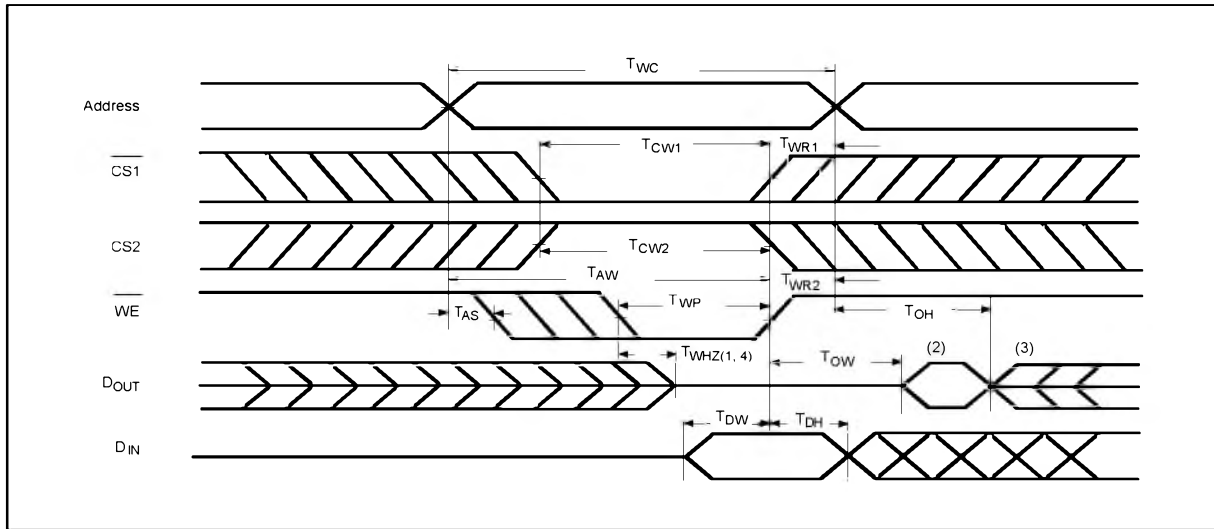

Notes:

1. During this period, I/O pins are in the output state, so input signals of opposite phase to the outputs should not be applied.
2. The data output from DOUT are the same as the data written to DIN during the write cycle.
3. DOUT provides the read data for the next address.
4. Transition is measured  $\pm 500$  mV from steady state with  $C_L = 5$  pF. This parameter is guaranteed but not 100% tested.



## ORDERING INFORMATION

PART NO.	ACCESS TIME (nS)	OPERATING CURRENT Max. (mA)	STANDBY CURRENT Max. (mA)	PACKAGE
W2465AK-12	12	180	5	300 mil skinny
W2465AK-15	15	150	5	300 mil skinny
W2465AK-20	20	120	5	300 mil skinny
W2465AJ-12	12	180	5	300 mil SOJ
W2465AJ-15	15	150	5	300 mil SOJ
W2465AJ-20	20	120	5	300 mil SOJ

Notes:

1. Winbond reserves the right to make changes to its products without prior notice.
2. Purchasers are responsible for performing appropriate quality assurance testing on products intended for use in applications where personal injury might occur as a consequence of product failure.

## PACKAGE DIMENSIONS

### 28-pin P-DIP Skinny

Symbol	Dimension in Inches			Dimension in mm		
	Min.	Nom.	Max.	Min.	Nom.	Max.
A	—	—	0.175	—	—	4.45
A <sub>1</sub>	0.010	—	—	0.25	—	—
A <sub>2</sub>	0.125	0.130	0.135	3.18	3.30	3.43
B	0.016	0.018	0.022	0.41	0.46	0.56
B <sub>1</sub>	0.058	0.060	0.064	1.47	1.52	1.63
c	0.008	0.010	0.014	0.20	0.25	0.36
D	—	1.388	1.400	—	35.26	35.56
E	0.300	0.310	0.320	7.62	7.87	8.13
E <sub>1</sub>	0.283	0.288	0.293	7.19	7.32	7.44
e <sub>1</sub>	0.090	0.100	0.110	2.29	2.54	2.79
L	0.120	0.130	0.140	3.05	3.30	3.56
a	0°	—	15°	0°	—	15°
e <sub>s</sub>	0.330	0.350	0.370	8.38	8.89	9.40
S	—	—	0.055	—	—	1.40

**Notes:**

- Dimension D Max. & S include mold flash or tie bar burrs.
- Dimension E<sub>1</sub> does not include interlead flash.
- Dimension D & E include mold mismatch and are determined at the mold parting line.
- Dimension B<sub>1</sub> does not include dambar protrusion/intrusion.
- Controlling dimension: Inches.
- General appearance spec. should be based on final visual inspection spec.

### 28-pin Small Outline J Band

Symbol	Dimension in Inches			Dimension in mm		
	Min.	Nom.	Max.	Min.	Nom.	Max.
A	—	—	0.140	—	—	3.56
A <sub>1</sub>	0.027	—	—	0.69	—	—
A <sub>2</sub>	0.095	0.100	0.105	2.41	2.54	2.67
b <sub>1</sub>	0.026	0.028	0.032	0.66	0.71	0.81
b	0.016	0.018	0.022	0.41	0.46	0.56
c	0.008	0.010	0.014	0.20	0.25	0.36
D	—	0.710	0.730	—	18.03	18.54
E	0.295	0.300	0.305	7.49	7.62	7.75
e <sub>1</sub>	0.044	0.050	0.056	1.12	1.27	1.42
e <sub>1</sub>	0.245	0.265	0.285	6.22	6.73	7.24
H <sub>E</sub>	0.327	0.337	0.347	8.31	8.56	8.81
L	0.077	0.087	0.097	1.96	2.21	2.46
S	—	—	0.045	—	—	1.14
y	—	—	0.004	—	—	0.10
θ	0°	—	10°	0°	—	10°

**Notes:**

- Dimension D Max. & S include mold flash or tie bar burrs.
- Dimension b does not include dambar protrusion/intrusion.
- Dimension D & E include mold mismatch and are determined at the mold parting line.
- Controlling dimension: Inches.
- General appearance spec. should be based on final visual inspection spec.





#### Headquarters

No. 4, Creation Rd. III,  
Science-Based Industrial Park,  
Hsinchu, Taiwan  
TEL: 886-3-5770066  
FAX: 886-3-5792647  
<http://www.winbond.com.tw/>  
Voice & Fax-on-demand: 886-2-7197006

#### Taipei Office

11F, No. 115, Sec. 3, Min-Sheng East Rd.,  
Taipei, Taiwan  
TEL: 886-2-7190505  
FAX: 886-2-7197502

#### Winbond Electronics (H.K.) Ltd.

Rm. 803, World Trade Square, Tower II,  
123 Hoi Bun Rd., Kwun Tong,  
Kowloon, Hong Kong  
TEL: 852-27513100  
FAX: 852-27552064

#### Winbond Electronics North America Corp.

Winbond Memory Lab.  
Winbond Microelectronics Corp.  
Winbond Systems Lab.  
2730 Orchard Parkway, San Jose,  
CA 95134, U.S.A.  
TEL: 1-408-9436666  
FAX: 1-408-9436668

Note: All data and specifications are subject to change without notice.