

PLL FREQUENCY SYNTHESIZER AND CONTROLLER FOR FM/MW/LW TUNER (AUTOMOBILE APPLICATION)

The μ PD17012GF-058 is a CMOS LSI chip designed for use in FM/MW/LW tuners utilizing a PLL frequency synthesizer design for worldwide applications.

The device incorporates a PLL frequency synthesizer controller, prescaler, and frequency counter. The device enables detachable stereo systems, and is ideal for use in electronic volume control circuits for automobile applications, high-performance FM/MW/LW tuners with a clock, and similar applications where compact dimensions are essential.

FEATURES

- Capable of receiving broadcasts from stations in all of the world's FM and MW bands, as well as the European LW band
- Applicable to AM up-conversion
- Many preset functions including manual tuning, auto-tuning (seek, scan), and preset memory scanning
- Independent preset memory with six buttons: up to 18 FM stations (six stations, each enabling the setting of FM1, FM2, and FM3), up to 12 MW stations (six stations, each enabling the setting of MW1 and MW2), and up to six LW stations
- Last channel memory for three FM stations, two MW stations, and one LW station
- ST (stereo) display (The ST display is also supported for the MW band.)
- Display and control output of MTL (METAL)
- Auto-preset memory function
- "CD" (compact disc)/"TRPE" (cassette tape) display
- LOUD (loudness) control output and display
- Clock function for 12-hour or 24-hour clock display
- Compatible with the external LCD controller/driver (μ PD7225)
- Built-in prescaler and frequency counter
- Remote-controller signal receiving function (when the μ PD6121 is used for transmitting signals)
- Detachable keys (or key section) and LCD panel
- Electronic volume control function (compatible with the I²C bus)
- Alarm function

ORDERING INFORMATION

Part number	Package
μ PD17012GF-058-3BE	64-pin plastic QFP (14 × 20 mm, 1.0 mm pitch)

The information in this document is subject to change without notice.

FUNCTION OVERVIEW

FREQUENCY TO BE RECEIVED, CHANNEL SEPARATION, REFERENCE FREQUENCY, AND INTERMEDIATE FREQUENCY

Area	Band	Frequency to be received	Channel separation	Reference frequency	Intermediate frequency
Eastern Europe	FM1	65 - 74 MHz	50 kHz	25 kHz	10.7 MHz
	FM2 FM3	87.5 - 108.0 MHz	50 kHz	25 kHz	10.7 MHz
	MW	522 - 1 620 kHz	9 kHz	9 kHz	450 kHz/+10.71 MHz
	LW	144 - 290 kHz	1 kHz	1 kHz	450 kHz/+10.71 MHz
Western Europe	FM	87.5 - 108.0 MHz	50 kHz	25 kHz	10.7 MHz
	MW	522 - 1 620 kHz	9 kHz	9 kHz	450 kHz/+10.71 MHz
	LW	144 - 290 kHz	1 kHz	1 kHz	450 kHz/+10.71 MHz
China	FM	87.0 - 108.0 MHz	50 kHz	25 kHz	10.7 MHz
	MW	531 - 1 602 kHz	9 kHz	9 kHz	450 kHz/+10.71 MHz
Australia, Middle East	FM	87.5 - 108.0 MHz	100 kHz	25 kHz	10.7 MHz
	MW	531 - 1 602 kHz	9 kHz	9 kHz	450 kHz/+10.71 MHz
U.S.A. 1	FM	87.5 - 108.0 MHz	100 kHz	25 kHz	10.7 MHz
	MW	530 - 1 620 kHz	10 kHz	10 kHz	450 kHz/+10.71 MHz
U.S.A. 2	FM	87.5 - 107.9 MHz	200 kHz	25 kHz	10.7 MHz
	MW	530 - 1 620 kHz	10 kHz	10 kHz	450 kHz/+10.71 MHz
U.S.A. 3	FM	87.5 - 107.9 MHz	200 kHz	25 kHz	10.7 MHz
	MW	530 - 1 710 kHz	10 kHz	10 kHz	450 kHz/+10.71 MHz
Japan	FM	76.0 - 90.0 MHz	100 kHz	25 kHz	-10.7 MHz
	MW	522 - 1 629 kHz	9 kHz	9 kHz	450 kHz/+10.71 MHz

RADIO FUNCTIONS

(1) Manual tuning

Function	Description
Manual up Manual down	Carries out tuning in step-by-step or fast-forward mode.

(2) Auto-tuning

Function	Description
Seek up	Detects a station and retains the frequency.
Scan up Scan down	Tunes to broadcasts of different stations for five seconds each.

(3) Preset memory scanning: Tunes to broadcasts of stations held in preset memory for five seconds each.

- (4) Preset memory
 - FM band: FM1: Six stations, FM2: Six stations, FM3: Six stations
 - MW band: MW1: Six stations, MW2: Six stations
 - LW band: Six stations
- (5) Last channel memory: One station each for FM1, FM2, FM3, MW1, MW2, LW
- (6) LOC (local) control output and display (The auto local function can be selected.)
- (7) ST (stereo) display function: Supported for the FM band. The display function is also supported for the MW band.
(A switching function is supported.)
- (8) Auto-storage

TAPE FUNCTIONS

- (1) Tape running direction display: Can be blinked at 2.5 Hz in fast-forward mode
- (2) MTL (METAL) control output and display
- (3) "TAPPE" (cassette tape) display function

ELECTRONIC VOLUME CONTROL FUNCTIONS

- (1) Volume/bass/treble/balance/fader function
- (2) "VOL" "BASS" "TRE" "BAL" "FAD" display on the LCD panel
- (3) Mute function (In the mute state, the entire panel display blinks.)
- (4) Loudness function
- (5) Four selectable gain levels (0 dB, 3.75 dB, 7.5 dB, or 11.25 dB)

CLOCK FUNCTIONS

- (1) Selectable 12-hour clock display (with AM/PM indication) or 24-hour clock display
- (2) Selectable colon (:) flashing (1 Hz)
- (3) Capable of back-up with low current consumption (up to 10 μ A) in no-clock mode

SECURITY FUNCTION

Enables of setting of the alarm function for security against car theft

OTHERS

- (1) LOUD (loudness) control output and display: Common to radio, tape, and CD modes
- (2) Key acknowledge (beep) output: Performed if a valid momentary key is on
- (3) Display switching function and privileged display function
- (4) "CD" (compact disc) display
- (5) Compatible with the external LCD controller/driver (μ PD7225)
- (6) Remote-controller signal receiving function (when the μ PD6121 is used for transmitting signals)
- (7) Detachable keys (or key section) and LCD panel

PIN CONFIGURATION (TOP VIEW)

64-pin plastic QFP (14 × 20 mm, 1.0 mm pitch)

μPD17012GF-058-3BE

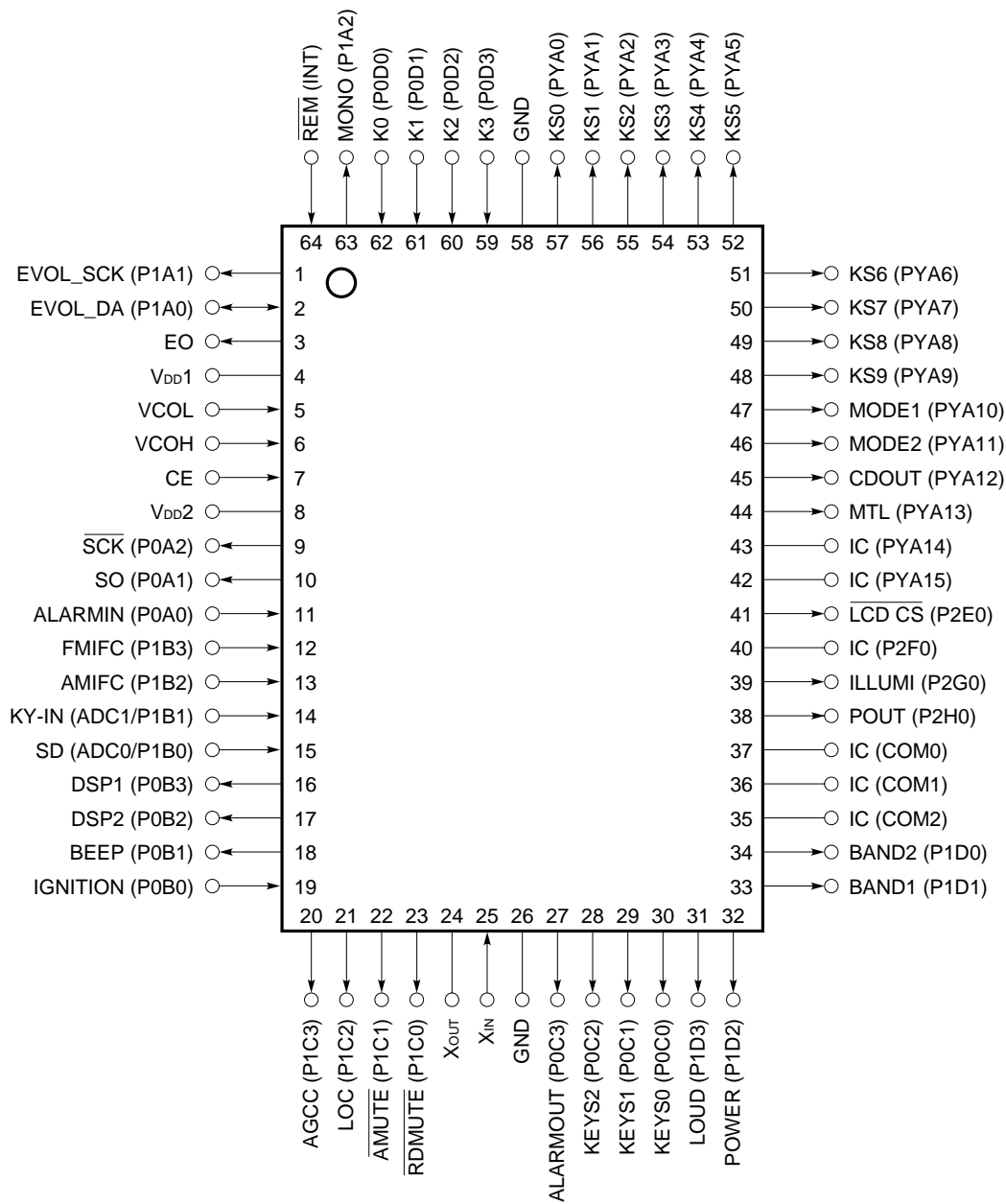

Remarks 1. The pin names enclosed in parentheses are those for the μPD17012GF-xxx-3BE.

2. IC indicates that the pin is internally connected. Leave the IC pins open.

CONTENTS

1. PIN FUNCTIONS	7
2. KEY MATRIX STRUCTURE	14
2.1 Placement of the Initial Setting Diode, Alternation, and Transistor Switch Matrixes	14
2.2 Switch Connection	14
2.3 Initial Setting Diode, Alternation, and Transistor Switch Matrix Connection	15
2.4 Momentary Key Matrix Placement	16
2.5 Momentary Key Matrix Connection	16
2.6 Description of the Key Matrixes	17
2.6.1 Initial setting diode matrixes	17
2.6.2 Alternation or transistor switch	28
2.6.3 Momentary keys	29
3. ALARM FUNCTION	52
3.1 Overview of the Alarm Function	52
3.2 Setting Alarm Mode	53
4. MODE TRANSITION	59
5. DISPLAY	66
5.1 LCD Panel	66
5.2 Character Style	66
5.3 Examples of Display	66
5.4 LCD Assignment	67
5.5 Pin Assignment of the LCD Controller/Driver (μPD7225)	67
5.6 Description of Display	68
6. REMOTE CONTROL FUNCTION	70
6.1 Remote-Controller Key Placement (When the μPD6121G Is Used)	70
6.2 Remote-Controller Keys	71
6.3 Remote-Controller Data Codes	71
6.4 Example of a Remote-Controller Circuit Using the μPD6121G-001	72
6.5 Example of a Remote-Controller Preamplicifier Circuit Using the μPC2800HA	72
7. MUTE OUTPUT TIMING CHARTS	73
7.1 Radio Mute (<u>RDMUTE</u> Pin) Output Timing Charts	73
7.2 Radio Mute (<u>RDMUTE</u> Pin) and Audio Mute (<u>AMUTE</u> Pin) Output Timing Charts	76
8. PIN I/O CIRCUITS	78

9. SAMPLE APPLICATION CIRCUITS	82
10. ELECTRICAL CHARACTERISTICS (PRELIMINARY)	83
11. PACKAGE DRAWING	86
12. RECOMMENDED SOLDERING CONDITIONS	87
APPENDIX COMMUNICATION WITH ELECTRONIC VOLUME CONTROL IC (I ² C BUS INTERFACE)	88

1. PIN FUNCTIONS

Pin No.	Symbol	Pin name	Description	I/O type
1	EVOL_SCK	Clock output of electronic volume control	Clock output pin of electronic volume control For details of data output, see Appendix .	CMOS push-pull output
2	EVOL_DA	Data input/output of electronic volume control	Data input/output pin of electronic volume control For details of data output, see Appendix .	Input/output CMOS push-pull output
3	EO	Error out	Charge pump output pin of phase detector built into a PLL. If a divided oscillator frequency is higher than the reference frequency, the output of this pin goes high. If the divided oscillator frequency is lower, the output goes low. If the divided oscillator frequency agrees with the reference frequency, the output enters the floating state.	CMOS tristate output
4 8	V _{DD1} V _{DD2}	Power supply	Power-supply pin of the device This pin supplies a voltage of 5 V ±10 % while the device is operating. The rise time (0 to 4.5 V) of V _{DD} must not exceed 500 ms. If the rise time is significantly long or if the voltage falls below the operating voltage but is between 0 V and 3.5 V, the state of an initial setting diode switch may be read incorrectly.	-
5	VCOL	AM local oscillator input	Input pin of the local oscillator output (VCO) in the AM (MW, LW) band When tuned to broadcasts in the MW or LW band, this pin becomes active. Otherwise, the pin is internally pulled down. To protect the built-in AC amplifier, block the flow of direct current with a capacitor, then input the frequency.	Input
6	VCOH	FM local oscillator input	Input pin of the local oscillator output (VCO) in the FM band When tuned to broadcasts in the FM band, this pin becomes active. Otherwise, the pin is internally pulled down. Because an AC amplifier is incorporated, block the flow of direct current with a capacitor, then input the frequency.	Input
7	CE	Chip enable	Input pin of the device selection signal Always pull up the pin.	Input
9	$\overline{\text{SCK}}$	Serial clock output	Serial clock output pin for controlling the LCD controller/driver (μPD7225)	CMOS push-pull output
10	SO	Serial data output	Serial data output pin for controlling the LCD controller/driver (μPD7225)	CMOS push-pull output
11	ALARMIN	Door switch input	Input pin of the door switch See Chapter 3 for details.	Input

Pin No.	Symbol	Pin name	Description	I/O type												
12	FMIFC	FM intermediate frequency input	<p>Input pin of the intermediate frequency (IF) in the FM band To protect the built-in AC amplifier, block the flow of direct current with a capacitor, then input the frequency. When the ENFMIF switch (initial setting diode) is set to 1, this pin is used to detect a station during auto-tuning. If the input frequency range and conditions listed below are satisfied, it is judged that a station has been found.</p> <table border="1"> <thead> <tr> <th>Item</th> <th>Input frequency range <1></th> <th>Input frequency range <2></th> </tr> </thead> <tbody> <tr> <td>Band</td> <td></td> <td></td> </tr> <tr> <td>FM</td> <td>10.7 MHz ±50 kHz</td> <td>10.7 MHz ±12.5 kHz</td> </tr> </tbody> </table> <p>A frequency within input frequency range <1> must be input within 20 ms of the PLL being locked. If a frequency is included in both input frequency ranges <1> and <2>, it is judged that a station has been found. Auto-tuning is stopped.</p>	Item	Input frequency range <1>	Input frequency range <2>	Band			FM	10.7 MHz ±50 kHz	10.7 MHz ±12.5 kHz	Input			
Item	Input frequency range <1>	Input frequency range <2>														
Band																
FM	10.7 MHz ±50 kHz	10.7 MHz ±12.5 kHz														
13	AMIFC	AM intermediate frequency input	<p>Input pin for the intermediate frequency (IF) in the AM (MW, LW) band. To protect the built-in AC amplifier, block the flow of direct current with a capacitor, then input the frequency. If the initial setting diode ENAMIF is set to 1, this pin is used to detect whether a station is found in auto-tuning. If the input frequency range and conditions listed below are satisfied, it is judged that a station has been found.</p> <table border="1"> <thead> <tr> <th>Item</th> <th>Input frequency range <1> [kHz]</th> <th>Input frequency range <2> [kHz]</th> </tr> </thead> <tbody> <tr> <td>Band</td> <td></td> <td></td> </tr> <tr> <td>MW</td> <td>450 ± 5</td> <td>450 ± 2</td> </tr> <tr> <td>LW</td> <td>450 ± 5</td> <td>450 ± 0.5</td> </tr> </tbody> </table> <p>A frequency within input frequency range <1> must be input within 20 ms of the PLL being locked. If a frequency is included in both input frequency ranges <1> and <2>, it is judged that a station has been found. Auto-tuning is stopped.</p>	Item	Input frequency range <1> [kHz]	Input frequency range <2> [kHz]	Band			MW	450 ± 5	450 ± 2	LW	450 ± 5	450 ± 0.5	Input
Item	Input frequency range <1> [kHz]	Input frequency range <2> [kHz]														
Band																
MW	450 ± 5	450 ± 2														
LW	450 ± 5	450 ± 0.5														
14	KY-IN	Key input	Input pin for the key return signal of the momentary key matrix	Input												

Pin No.	Symbol	Pin name	Description	I/O type											
21	LOC	Local signal output	<p>Local signal output pin in radio mode</p> <p>The operation depends on the mode, as described below:</p> <p>(1) In radio mode, radio-monitor tape mode, radio-monitor CD mode</p> <p>The LOC output goes high only in auto-tuning in the local state. The level of the LOC output depends on both the tuning state and LOCAL/DX state. The relationships are listed below:</p> <table border="1" style="margin-left: 20px;"> <thead> <tr> <th>Auto-tuning state</th> <th>LOCAL/DX state</th> <th>LOC output level</th> </tr> </thead> <tbody> <tr> <td rowspan="2">In progress</td> <td>LOCAL</td> <td>High</td> </tr> <tr> <td>DX</td> <td>Low</td> </tr> <tr> <td>Not performed</td> <td>Don't care</td> <td>Low</td> </tr> </tbody> </table> <p>(2) In other modes</p> <p>The output goes low.</p>	Auto-tuning state	LOCAL/DX state	LOC output level	In progress	LOCAL	High	DX	Low	Not performed	Don't care	Low	CMOS push-pull output
Auto-tuning state	LOCAL/DX state	LOC output level													
In progress	LOCAL	High													
	DX	Low													
Not performed	Don't care	Low													
22	$\overline{\text{AMUTE}}$	Audio mute output	<p>Output pin of the tape or CD mute signal</p> <p>The operation depends on the mode, as described below:</p> <p>(1) In radio mode, radio-monitor tape mode, radio-monitor CD mode, power-off mode</p> <p>The output goes low.</p> <p>(2) In CD mode and tape mode</p> <p>The output goes high.</p> <p>See Chapter 7 for details.</p>	CMOS push-pull output											
23	$\overline{\text{RDMUTE}}$	Radio mute output	<p>Output pin of radio mute signal</p> <p>The operation depends on the mode, as described below:</p> <p>(1) In radio mode, radio-monitor tape mode, radio-monitor CD mode; at radio-on, radio-off; at band switching; at switching of the frequency to be received</p> <p>The output goes low.</p> <p>(2) In CD mode and tape mode</p> <p>The output method can be selected by setting the initial setting diode MUTESEL. (See Section 2.6.1.) If the radio-monitor function is used, set MUTESEL to 0 and bring the output low.</p> <p>See Chapter 7 for details.</p>	CMOS push-pull output											
24	X _{OUT}	Crystal	Pin for connecting a crystal	-											
25	X _{IN}		A 4.5-MHz crystal is connected.	Input											
26 58	GND	Ground	Ground pin Connect pins No. 26 and No. 58 to an identical potential.	-											
27	ALARMOUT	Alarm-out output	Alarm-out output pin See Chapter 3 for details.	CMOS push-pull output											
28 30	KEYS2 KEYS0	Key source signal output	Output pin for the key source signal for the momentary key matrix.	N-ch open-drain output											
31	LOUD	Loudness output	Output pin for the loudness control signal When the loudness state is set, the output goes high.	CMOS push-pull output											

Pin No.	Symbol	Pin name	Description	I/O type															
32	POWER	Power output	The output is inverted each time the POWER key is pressed. Use this pin to turn the radio on or off. Connecting this pin to transistor switch RDSET enables power-on and off of the radio.	CMOS push-pull output															
33 34	BAND1 BAND2	Band switching signal output	Output pin of the band switching signal in radio mode The operation depends on the mode, as described below: (1) In radio mode, radio-monitor tape mode, radio-monitor CD mode If the band to be received is switched by pressing the band switching key, the output depends on the band, as listed below: <table border="1" style="margin: 10px auto;"> <thead> <tr> <th>Pin Band</th> <th>BAND1</th> <th>BAND2</th> </tr> </thead> <tbody> <tr> <td>MW</td> <td>0</td> <td>0</td> </tr> <tr> <td>LW</td> <td>0</td> <td>1</td> </tr> <tr> <td>FM</td> <td>1</td> <td>0</td> </tr> </tbody> </table> (0: Low, 1: High) (2) In tape mode, CD mode, power-off mode The output goes low.	Pin Band	BAND1	BAND2	MW	0	0	LW	0	1	FM	1	0	CMOS push-pull output			
Pin Band	BAND1	BAND2																	
MW	0	0																	
LW	0	1																	
FM	1	0																	
35 37 40 42 43	IC	IC	Internally connected pin. Leave the pins open.	-															
38	POUT	Detachable panel state signal	Output pin of the detachable panel state signal When the DTH switch is set to off, the pin outputs the detachable panel state signal, having a frequency of 1 Hz and a duty cycle of 1/2.	CMOS push-pull output															
39	ILLUMI	Illumination signal output	Illumination signal output pin The output methods are selected according to the states of the ILLA and ILLB initial setting diodes, as follows: <table border="1" style="margin: 10px auto;"> <thead> <tr> <th>ILLA</th> <th>ILLB</th> <th>Function</th> </tr> </thead> <tbody> <tr> <td>0</td> <td>0</td> <td>Loudness function only</td> </tr> <tr> <td>0</td> <td>1</td> <td>Loudness/illumination functions</td> </tr> <tr> <td>1</td> <td>0</td> <td>Loudness/illumination functions</td> </tr> <tr> <td>1</td> <td>1</td> <td>Loudness function only</td> </tr> </tbody> </table> (1: Shorted by the diode; 0: Open)	ILLA	ILLB	Function	0	0	Loudness function only	0	1	Loudness/illumination functions	1	0	Loudness/illumination functions	1	1	Loudness function only	CMOS push-pull output
ILLA	ILLB	Function																	
0	0	Loudness function only																	
0	1	Loudness/illumination functions																	
1	0	Loudness/illumination functions																	
1	1	Loudness function only																	
41	$\overline{\text{LCD CS}}$	LCD chip select signal output	Output pin for the chip select signal This pin is used as an output pin of the chip select signal for the external LCD controller/driver (μPD7225). When the output goes low, the external LCD controller/driver is enabled.	CMOS push-pull output															

Caution When the μPD7225 external LCD controller/driver is used, connect the $\overline{\text{C/D}}$ pin to the V_{DD} pin at the μPD7225.

Pin No.	Symbol	Pin name	Description	I/O type																							
44	MTL	METAL signal output	<p>METAL signal output pin</p> <p>The output level depends on the METAL state, as listed below:</p> <table border="1"> <thead> <tr> <th>METAL state</th> <th>Output level</th> </tr> </thead> <tbody> <tr> <td>ON</td> <td>High</td> </tr> <tr> <td>OFF</td> <td>Low</td> </tr> </tbody> </table> <p>If the TPSET switch is set to on, the output level depends on the METAL state, regardless of the current mode.</p>	METAL state	Output level	ON	High	OFF	Low	CMOS push-pull output																	
METAL state	Output level																										
ON	High																										
OFF	Low																										
45	CDOUT	CD mode output	<p>CD mode output pin</p> <p>Each time the [CD] momentary key is pressed, the CDOUT output is inverted. In the following modes, the CDOUT output is always set low:</p> <ul style="list-style-type: none"> ● When IGNITION is low ● In power-off mode (when IGNITION is high and the radio, tape, and CD are off) ● When the DTH transistor switch is set to off 	CMOS push-pull output																							
46 47	MODE2 MODE1	Mode signal output	<p>Mode switching signal output pin</p> <p>The output depends on the mode, as listed below:</p> <table border="1"> <thead> <tr> <th>Mode</th> <th>MODE1</th> <th>MODE2</th> </tr> </thead> <tbody> <tr> <td>When IGNITION is low</td> <td>0</td> <td>0</td> </tr> <tr> <td>When IGNITION is high and the radio, tape, and CD are off (power-off mode)</td> <td>0</td> <td>0</td> </tr> <tr> <td>In radio mode</td> <td>1</td> <td>0</td> </tr> <tr> <td>In tape mode</td> <td>0</td> <td>0</td> </tr> <tr> <td>In CD mode</td> <td>0</td> <td>1</td> </tr> <tr> <td>In radio-monitor tape mode</td> <td rowspan="2">1</td> <td>0</td> </tr> <tr> <td>In radio-monitor CD mode</td> <td>1</td> </tr> </tbody> </table> <p>(0: Low, 1: High)</p>	Mode	MODE1	MODE2	When IGNITION is low	0	0	When IGNITION is high and the radio, tape, and CD are off (power-off mode)	0	0	In radio mode	1	0	In tape mode	0	0	In CD mode	0	1	In radio-monitor tape mode	1	0	In radio-monitor CD mode	1	CMOS push-pull output
Mode	MODE1	MODE2																									
When IGNITION is low	0	0																									
When IGNITION is high and the radio, tape, and CD are off (power-off mode)	0	0																									
In radio mode	1	0																									
In tape mode	0	0																									
In CD mode	0	1																									
In radio-monitor tape mode	1	0																									
In radio-monitor CD mode		1																									
48 57	KS9 KS0	Key source signal output	Output pin of the key source signal of the key matrix	CMOS push-pull output																							
59 62	K3 K0	Key return signal input	Input pin of the key return signal of the key matrix	Input																							

Pin No.	Symbol	Pin name	Description	I/O type																						
63	MONO	MONO signal output	<p>MONO signal output pin</p> <p>This pin functions as a MONO signal output pin in radio mode, radio-monitor tape mode, or radio-monitor CD mode.</p> <p>The output level depends on the selected band and the MONO state, as listed below:</p> <table border="1"> <thead> <tr> <th>Selected band</th> <th>MONO state</th> <th>Output level</th> </tr> </thead> <tbody> <tr> <td rowspan="2">FM</td> <td>ON</td> <td>High</td> </tr> <tr> <td>OFF</td> <td>Low</td> </tr> <tr> <td>LW</td> <td>Don't care</td> <td>Low</td> </tr> </tbody> </table> <p>If the MW band is selected, the output level depends on the setting of the initial setting diode MWS, as listed below:</p> <table border="1"> <thead> <tr> <th>MWS</th> <th>MONO state</th> <th>Output level</th> </tr> </thead> <tbody> <tr> <td rowspan="2">1</td> <td>ON</td> <td>High</td> </tr> <tr> <td>OFF</td> <td>Low</td> </tr> <tr> <td>0</td> <td>Don't care</td> <td>Low</td> </tr> </tbody> </table> <p>(1: Shorted by the diode, 0: Open)</p>	Selected band	MONO state	Output level	FM	ON	High	OFF	Low	LW	Don't care	Low	MWS	MONO state	Output level	1	ON	High	OFF	Low	0	Don't care	Low	CMOS push-pull output
Selected band	MONO state	Output level																								
FM	ON	High																								
	OFF	Low																								
LW	Don't care	Low																								
MWS	MONO state	Output level																								
1	ON	High																								
	OFF	Low																								
0	Don't care	Low																								
64	$\overline{\text{REM}}$	Remote-controller signal input	<p>Input pin for the infrared remote-controller signal. The output of the preamplifier (such as μPC2800HA) of a remote controller is connected. Use the μPD6121G to send signals from the remote-controller.</p>	Input																						

2. KEY MATRIX STRUCTURE

2.1 Placement of the Initial Setting Diode, Alternation, and Transistor Switch Matrixes

Input pin (pin number) / Output pin (pin number)	K3 (59)	K2 (60)	K1 (61)	K0 (62)
KS9 (48)	-	DISALARM	VOLATT_L	VOLATT_H
KS8 (49)	RDSET	ST	DTH	VKYSEL
KS7 (50)	FF	RL	CDSET	TPSET
KS6 (51)	IFAM	-	-	MWS
KS5 (52)	AUTO500	MUTESEL	AUTOLOC	FAD_SEL
KS4 (53)	CKHLT	ILLA	ILLB	KTAPE
KS3 (54)	NOCLK	CLKDISP	FLASH	DISAMEMO
KS2 (55)	ENFMIF	ENAMIF	PRIO2	PRIO1
KS1 (56)	ENFM	DISFM3	ENMW2	DISLW
KS0 (57)	-	AREA3	AREA2	AREA1

 : Initial setting diode matrix

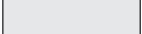
 : Alternation or transistor switch

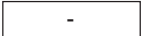
 : Open

2.2 Switch Connection

Alternation switch

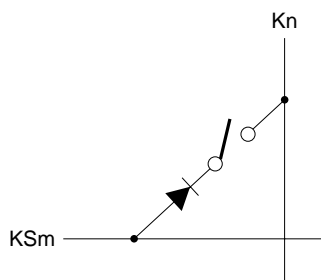

Transistor switch

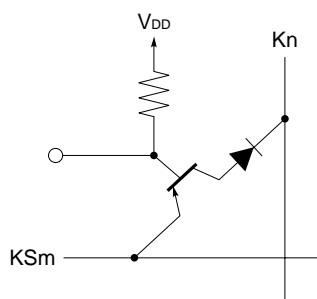

Initial setting diode

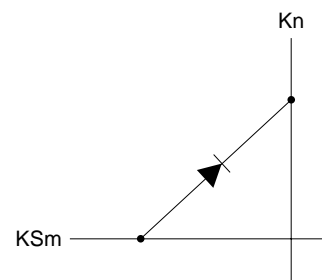

2.3 Initial Setting Diode, Alternation, and Transistor Switch Matrix Connection

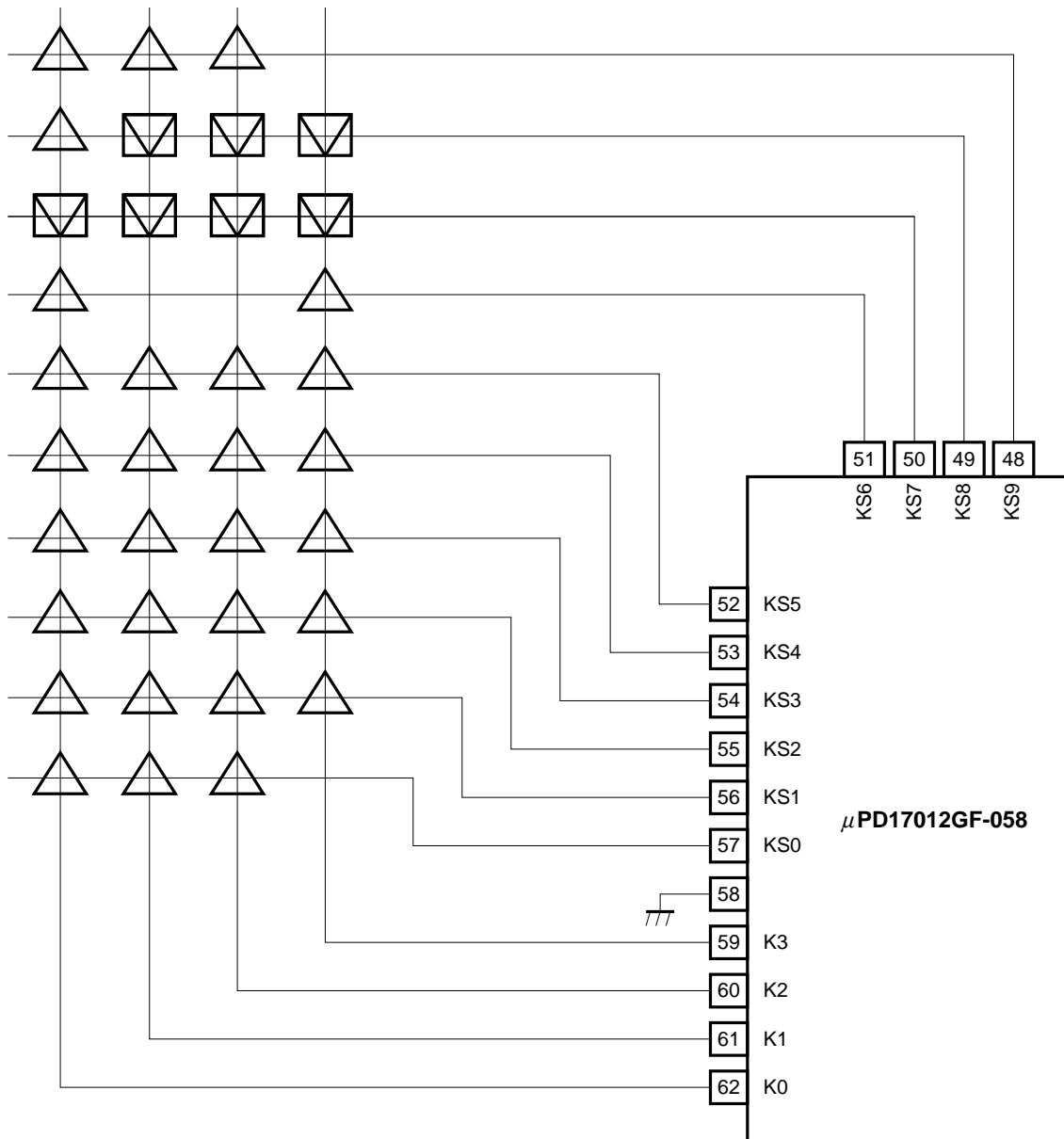
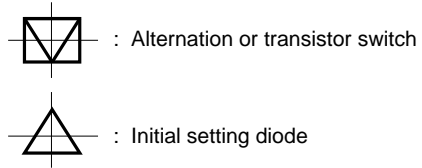

2.4 Momentary Key Matrix Placement

Input voltage Selection pin (pin number)	0 to 0.04 V _{DD}	0.05 to 0.12 V _{DD}	0.13 to 0.20 V _{DD}	0.21 to 0.29 V _{DD}	0.30 to 0.38 V _{DD}	0.39 to 0.48 V _{DD}	0.49 to 0.57 V _{DD}	0.58 to 0.66 V _{DD}	0.67 to 0.76 V _{DD}	0.77 to 0.84 V _{DD}	0.85 to 0.91 V _{DD}
KEYS0 (30)	M1	M2	M3	M4	M5	M6	SEEK UP	ALARM	MAN UP	MAN DWN	MONO/ LOC
KEYS1 (29)	BAND	CD	POWER	VOL UP	VOL DWN	VOL SEL	LOUD/ ILLMI- NATION	MUTE	DISP	DSP	P.SCAN
KEYS2 (28)	RDMONI	SCAN UP	SCAN DWN	-	-	MTL	-	-	-	-	-

- : Open

2.5 Momentary Key Matrix Connection

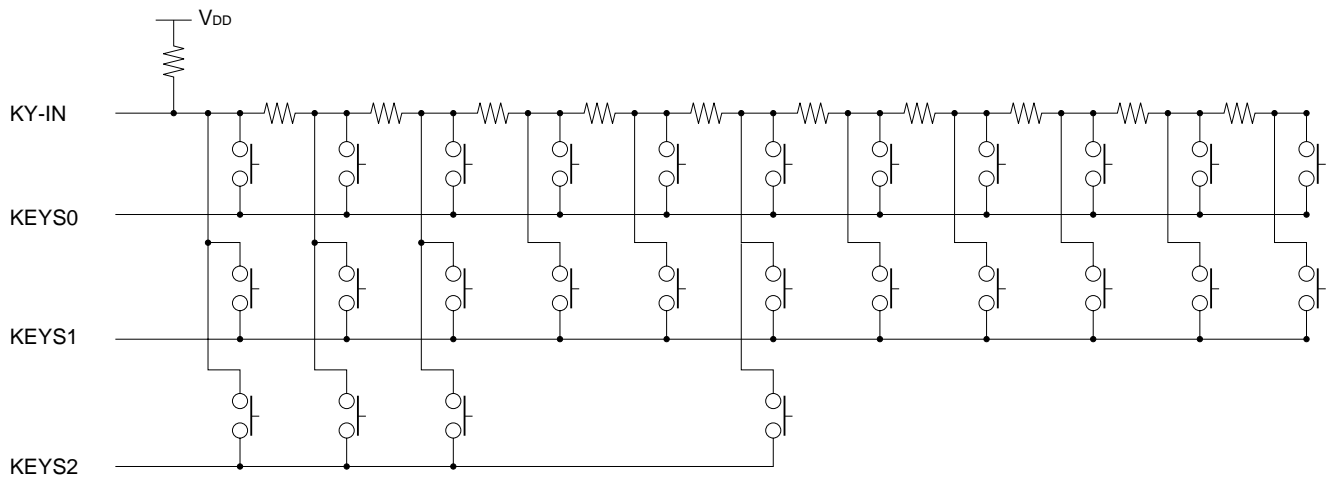

2.6 Description of the Key Matrixes

2.6.1 Initial setting diode matrixes

The μ PD17012GF-058 has the following 18 initial setting diode matrixes. When the V_{DD} is supplied with power for the first time (at a power-on reset), the states of the diodes in these matrixes are read in. In all other occasions, they are ignored.

(1) Switches to specify the reception area

AREA1, AREA2, and AREA3

(2) Switches to specify the reception band

DISFM3, DISLW, ENFM, and ENMW2

(3) Switch to specify whether to use the auto-storage function

DISAMEMO

(4) Switches to specify whether to use the frequency counter for detecting broadcasting stations

ENAMIF and ENFMIF

(5) Switch to specify tuning operation

AUTO500

(6) Switches to specify display priority

PRI01 and PRI02

(7) Switches to specify the clock function

CLKDISP, FLASH, and NOCLK

(8) Switches to specify the tape function

KTAPE

(9) Switch to specify the mute output

MUTESEL

(10) Switch to specify the local operation

AUTOLOC

(11) Switch to specify the intermediate frequency for the AM (MW, LW) band

IFAM

(12) Switch to specify whether the MW band stereo reception function is available

MWS

(13) Switch to specify that the standby mode has no clock

CKHLT

(14) Switch to specify whether the electronic volume control fader function is available

FAD_SEL

(15) Switch to specify which key (VOL UP/VOL DWN or MAN UP/MAN DWN) is used for electronic volume control

VKysel

(16) Switches to specify the gain of the electronic volume control

VOLATT_H and VOLATT_L

(17) Switches for setting illumination control

ILLA and ILLB

(18) Switch for specifying whether the alarm function is used





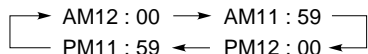
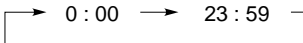
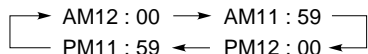
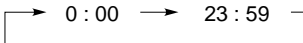
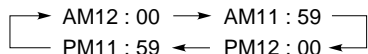
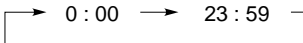

DISALARM

To set these switches to 1, short the diodes in each matrix. To set these switches to 0, keep the diodes open. The functions of the initial setting diode matrixes are summarized below (in alphabetical order).

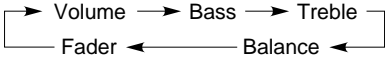
Initial setting diode	Description																																				
<p>AREA1 AREA2 AREA3</p>	<p>These switches are used to specify the reception area. The following table lists the settings of the switches and the corresponding reception areas. See the summary of functions for the reception frequencies in each reception area.</p> <table border="1" data-bbox="423 327 1141 789"> <thead> <tr> <th>AREA3</th> <th>AREA2</th> <th>AREA1</th> <th>Area</th> </tr> </thead> <tbody> <tr> <td>0</td> <td>0</td> <td>0</td> <td>Western Europe</td> </tr> <tr> <td>0</td> <td>0</td> <td>1</td> <td>Australia Middle and Near East</td> </tr> <tr> <td>0</td> <td>1</td> <td>0</td> <td>Japan</td> </tr> <tr> <td>0</td> <td>1</td> <td>1</td> <td>USA 1</td> </tr> <tr> <td>1</td> <td>0</td> <td>0</td> <td>USA 2</td> </tr> <tr> <td>1</td> <td>0</td> <td>1</td> <td>Eastern Europe</td> </tr> <tr> <td>1</td> <td>1</td> <td>0</td> <td>USA 3</td> </tr> <tr> <td>1</td> <td>1</td> <td>1</td> <td>China</td> </tr> </tbody> </table> <p>(1: Shorted by the diode; 0: Open)</p>	AREA3	AREA2	AREA1	Area	0	0	0	Western Europe	0	0	1	Australia Middle and Near East	0	1	0	Japan	0	1	1	USA 1	1	0	0	USA 2	1	0	1	Eastern Europe	1	1	0	USA 3	1	1	1	China
AREA3	AREA2	AREA1	Area																																		
0	0	0	Western Europe																																		
0	0	1	Australia Middle and Near East																																		
0	1	0	Japan																																		
0	1	1	USA 1																																		
1	0	0	USA 2																																		
1	0	1	Eastern Europe																																		
1	1	0	USA 3																																		
1	1	1	China																																		
<p>AUTO500</p>	<p>This switch specifies the function of the MAN UP and MAN DWN keys. With the AUTO500 switch, it is possible to use the MAN UP and MAN DWN keys also for auto-tuning (seek operation), as follows.</p> <table border="1" data-bbox="423 926 1442 1278"> <thead> <tr> <th>AUTO500</th> <th>MAN UP and MAN DWN key function</th> </tr> </thead> <tbody> <tr> <td>0</td> <td>Only manual tuning is performed. Each time the key is pressed, the frequency counter is incremented or decremented by one channel. Keeping the key pressed for at least 0.5 seconds triggers manual fast increment/decrement.</td> </tr> <tr> <td>1</td> <td>Both manual and auto-tuning are performed. Each time the key is pressed, the frequency counter is incremented or decremented by one channel. Keeping the key pressed for at least 0.5 seconds causes auto-tuning (seek operation) to begin at the next channel. The SEEK UP key becomes ineffective.</td> </tr> </tbody> </table> <p>(1: Shorted by the diode; 0: Open)</p>	AUTO500	MAN UP and MAN DWN key function	0	Only manual tuning is performed. Each time the key is pressed, the frequency counter is incremented or decremented by one channel. Keeping the key pressed for at least 0.5 seconds triggers manual fast increment/decrement.	1	Both manual and auto-tuning are performed. Each time the key is pressed, the frequency counter is incremented or decremented by one channel. Keeping the key pressed for at least 0.5 seconds causes auto-tuning (seek operation) to begin at the next channel. The SEEK UP key becomes ineffective.																														
AUTO500	MAN UP and MAN DWN key function																																				
0	Only manual tuning is performed. Each time the key is pressed, the frequency counter is incremented or decremented by one channel. Keeping the key pressed for at least 0.5 seconds triggers manual fast increment/decrement.																																				
1	Both manual and auto-tuning are performed. Each time the key is pressed, the frequency counter is incremented or decremented by one channel. Keeping the key pressed for at least 0.5 seconds causes auto-tuning (seek operation) to begin at the next channel. The SEEK UP key becomes ineffective.																																				

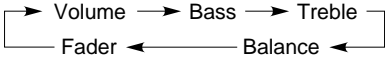
Initial setting diode	Description						
<p>AUTOLOC</p>	<p>This switch specifies the local function, as follows:</p> <table border="1" data-bbox="349 262 1364 903"> <thead> <tr> <th data-bbox="349 262 479 304">AUTOLOC</th> <th data-bbox="479 262 1364 304">Local function</th> </tr> </thead> <tbody> <tr> <td data-bbox="349 304 479 472">0</td> <td data-bbox="479 304 1364 472"> <p>Either or DX mode is selected according to a key entry (no auto local function available). Each time the MONO/LOC key is pressed, switching occurs between local and DX modes. The local output is high in the local mode during auto-tuning (seek, scan, or auto-store).</p> </td> </tr> <tr> <td data-bbox="349 472 479 903">1</td> <td data-bbox="479 472 1364 903"> <p>The auto local function is performed (if available). The MONO/LOC key becomes ineffective. Keeping the SEEK UP, SCAN UP, SCAN DWN or P.SCAN key for at least 2 seconds triggers auto-tuning, turns on the "LOC" display, and makes the local output high. After one cycle of auto-tuning is completed, a search begins in DX mode (with the "LOC" display off and local output at a low level). In modes other than auto-tuning, the "LOC" display is off and the local output is low. If a key for the same operation (for example, the SEEK UP key during seek operation) is pressed in local mode during auto-tuning, a search begins in DX mode at the same frequency used when auto-tuning began. If the key is pressed in DX mode, auto-tuning stops, and the frequency that was selected when auto-tuning began is reselected. The same operation as above occurs when the AUTO500 is set to 1 (by keeping the MAN UP or MAN DWN key pressed for at least 0.5 seconds).</p> </td> </tr> </tbody> </table> <p>(1: Shorted by the diode; 0: Open)</p>	AUTOLOC	Local function	0	<p>Either or DX mode is selected according to a key entry (no auto local function available). Each time the MONO/LOC key is pressed, switching occurs between local and DX modes. The local output is high in the local mode during auto-tuning (seek, scan, or auto-store).</p>	1	<p>The auto local function is performed (if available). The MONO/LOC key becomes ineffective. Keeping the SEEK UP, SCAN UP, SCAN DWN or P.SCAN key for at least 2 seconds triggers auto-tuning, turns on the "LOC" display, and makes the local output high. After one cycle of auto-tuning is completed, a search begins in DX mode (with the "LOC" display off and local output at a low level). In modes other than auto-tuning, the "LOC" display is off and the local output is low. If a key for the same operation (for example, the SEEK UP key during seek operation) is pressed in local mode during auto-tuning, a search begins in DX mode at the same frequency used when auto-tuning began. If the key is pressed in DX mode, auto-tuning stops, and the frequency that was selected when auto-tuning began is reselected. The same operation as above occurs when the AUTO500 is set to 1 (by keeping the MAN UP or MAN DWN key pressed for at least 0.5 seconds).</p>
AUTOLOC	Local function						
0	<p>Either or DX mode is selected according to a key entry (no auto local function available). Each time the MONO/LOC key is pressed, switching occurs between local and DX modes. The local output is high in the local mode during auto-tuning (seek, scan, or auto-store).</p>						
1	<p>The auto local function is performed (if available). The MONO/LOC key becomes ineffective. Keeping the SEEK UP, SCAN UP, SCAN DWN or P.SCAN key for at least 2 seconds triggers auto-tuning, turns on the "LOC" display, and makes the local output high. After one cycle of auto-tuning is completed, a search begins in DX mode (with the "LOC" display off and local output at a low level). In modes other than auto-tuning, the "LOC" display is off and the local output is low. If a key for the same operation (for example, the SEEK UP key during seek operation) is pressed in local mode during auto-tuning, a search begins in DX mode at the same frequency used when auto-tuning began. If the key is pressed in DX mode, auto-tuning stops, and the frequency that was selected when auto-tuning began is reselected. The same operation as above occurs when the AUTO500 is set to 1 (by keeping the MAN UP or MAN DWN key pressed for at least 0.5 seconds).</p>						
<p>CKHLT</p>	<p>When the DISALARM and NOCLK initial setting diodes = 1, and CE = low, the CKHLT switch specifies which standby mode is to be used, STOP or HALT.</p> <table border="1" data-bbox="349 1039 657 1165"> <thead> <tr> <th data-bbox="349 1039 470 1081">CKHLT</th> <th data-bbox="470 1039 657 1081">CE = low</th> </tr> </thead> <tbody> <tr> <td data-bbox="349 1081 470 1123">0</td> <td data-bbox="470 1081 657 1123">STOP mode</td> </tr> <tr> <td data-bbox="349 1123 470 1165">1</td> <td data-bbox="470 1123 657 1165">HALT mode</td> </tr> </tbody> </table> <p>(1: Shorted by the diode; 0: Open)</p>	CKHLT	CE = low	0	STOP mode	1	HALT mode
CKHLT	CE = low						
0	STOP mode						
1	HALT mode						
<p>CLKDISP</p>	<p>This switch specifies the clock display system (12/24) as follows:</p> <table border="1" data-bbox="349 1270 933 1564"> <thead> <tr> <th data-bbox="349 1270 470 1312">CLKDISP</th> <th data-bbox="470 1270 933 1312">Clock display system</th> </tr> </thead> <tbody> <tr> <td data-bbox="349 1312 470 1438">0</td> <td data-bbox="470 1312 933 1438"> <p>12-hour system</p>  </td> </tr> <tr> <td data-bbox="349 1438 470 1564">1</td> <td data-bbox="470 1438 933 1564"> <p>24-hour system</p>  </td> </tr> </tbody> </table> <p>(1: Shorted by the diode; 0: Open)</p>	CLKDISP	Clock display system	0	<p>12-hour system</p> 	1	<p>24-hour system</p> 
CLKDISP	Clock display system						
0	<p>12-hour system</p> 						
1	<p>24-hour system</p> 						
<p>DISALARM</p>	<p>This switch specifies whether the alarm function is used, as follows:</p> <table border="1" data-bbox="349 1669 657 1806"> <thead> <tr> <th data-bbox="349 1669 479 1711">DISALARM</th> <th data-bbox="479 1669 657 1711">Description</th> </tr> </thead> <tbody> <tr> <td data-bbox="349 1711 479 1753">0</td> <td data-bbox="479 1711 657 1753">Used</td> </tr> <tr> <td data-bbox="349 1753 479 1806">1</td> <td data-bbox="479 1753 657 1806">Not used</td> </tr> </tbody> </table> <p>(1: Shorted by the diode; 0: Open)</p>	DISALARM	Description	0	Used	1	Not used
DISALARM	Description						
0	Used						
1	Not used						

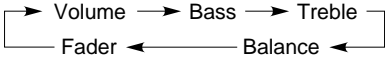
Initial setting diode	Description																																																																																										
DISAMEMO	<p>This switch is used to inhibit the auto-storage function, as follows:</p> <table border="1" data-bbox="423 260 1419 491"> <thead> <tr> <th data-bbox="423 260 581 302">DISAMEMO</th> <th data-bbox="581 260 1419 302">Description</th> </tr> </thead> <tbody> <tr> <td data-bbox="423 302 581 417">0</td> <td data-bbox="581 302 1419 417">The auto-storage function is enabled. Keeping the P.SCAN key pressed for at least 2 seconds triggers the auto-storage operation.</td> </tr> <tr> <td data-bbox="423 417 581 491">1</td> <td data-bbox="581 417 1419 491">The auto-storage function is disabled. The P.SCAN key can be used only for the preset scan function.</td> </tr> </tbody> </table> <p>(1: Shorted by the diode; 0: Open)</p>	DISAMEMO	Description	0	The auto-storage function is enabled. Keeping the P.SCAN key pressed for at least 2 seconds triggers the auto-storage operation.	1	The auto-storage function is disabled. The P.SCAN key can be used only for the preset scan function.																																																																																				
DISAMEMO	Description																																																																																										
0	The auto-storage function is enabled. Keeping the P.SCAN key pressed for at least 2 seconds triggers the auto-storage operation.																																																																																										
1	The auto-storage function is disabled. The P.SCAN key can be used only for the preset scan function.																																																																																										
DISFM3 DISLW ENFM ENMW2	<p>These switches are used to specify the reception band. Each switch has the following functions.</p> <ul style="list-style-type: none"> ○ DISFM3: When set to 1, disables the FM3 band. ○ ENMW2: When set to 1, enables the MW2 band. ○ DISLW: When set to 1, disables the LW band for Western Europe and Eastern Europe. This switch is ineffective in the other areas. ○ ENFM: When set to 1, enables only the FM band. <p>The following table lists the settings of these switches and the corresponding reception bands in each area.</p> <table border="1" data-bbox="423 821 1438 1535"> <thead> <tr> <th data-bbox="423 821 618 869">Area</th> <th data-bbox="618 821 727 869">ENFM</th> <th data-bbox="727 821 857 869">DISFM3</th> <th data-bbox="857 821 987 869">ENMW2</th> <th data-bbox="987 821 1101 869">DISLW</th> <th data-bbox="1101 821 1438 869">Reception band</th> </tr> </thead> <tbody> <tr> <td data-bbox="423 869 618 911">Western Europe</td> <td data-bbox="618 869 727 911">1</td> <td data-bbox="727 869 857 911">0</td> <td data-bbox="857 869 987 911">-</td> <td data-bbox="987 869 1101 911">-</td> <td data-bbox="1101 869 1438 911">FM1, FM2, FM3</td> </tr> <tr> <td data-bbox="423 911 618 953">Eastern Europe</td> <td data-bbox="618 911 727 953">1</td> <td data-bbox="727 911 857 953">1</td> <td data-bbox="857 911 987 953">-</td> <td data-bbox="987 911 1101 953">-</td> <td data-bbox="1101 911 1438 953">FM1, FM2</td> </tr> <tr> <td data-bbox="423 953 618 995"></td> <td data-bbox="618 953 727 995">0</td> <td data-bbox="727 953 857 995">0</td> <td data-bbox="857 953 987 995">0</td> <td data-bbox="987 953 1101 995">0</td> <td data-bbox="1101 953 1438 995">FM1, FM2, FM3, MW1, LW</td> </tr> <tr> <td data-bbox="423 995 618 1037"></td> <td data-bbox="618 995 727 1037">0</td> <td data-bbox="727 995 857 1037">0</td> <td data-bbox="857 995 987 1037">0</td> <td data-bbox="987 995 1101 1037">1</td> <td data-bbox="1101 995 1438 1037">FM1, FM2, FM3, MW1</td> </tr> <tr> <td data-bbox="423 1037 618 1079"></td> <td data-bbox="618 1037 727 1079">0</td> <td data-bbox="727 1037 857 1079">0</td> <td data-bbox="857 1037 987 1079">1</td> <td data-bbox="987 1037 1101 1079">-</td> <td data-bbox="1101 1037 1438 1079">FM1, FM2, FM3, MW1, MW2</td> </tr> <tr> <td data-bbox="423 1079 618 1121"></td> <td data-bbox="618 1079 727 1121">0</td> <td data-bbox="727 1079 857 1121">1</td> <td data-bbox="857 1079 987 1121">0</td> <td data-bbox="987 1079 1101 1121">0</td> <td data-bbox="1101 1079 1438 1121">FM1, FM2, MW1, LW</td> </tr> <tr> <td data-bbox="423 1121 618 1163"></td> <td data-bbox="618 1121 727 1163">0</td> <td data-bbox="727 1121 857 1163">1</td> <td data-bbox="857 1121 987 1163">0</td> <td data-bbox="987 1121 1101 1163">1</td> <td data-bbox="1101 1121 1438 1163">FM1, FM2, MW1</td> </tr> <tr> <td data-bbox="423 1163 618 1205"></td> <td data-bbox="618 1163 727 1205">0</td> <td data-bbox="727 1163 857 1205">1</td> <td data-bbox="857 1163 987 1205">1</td> <td data-bbox="987 1163 1101 1205">-</td> <td data-bbox="1101 1163 1438 1205">FM1, FM2, MW1, MW2</td> </tr> <tr> <td data-bbox="423 1205 618 1247">The other areas</td> <td data-bbox="618 1205 727 1247">1</td> <td data-bbox="727 1205 857 1247">0</td> <td data-bbox="857 1205 987 1247">-</td> <td data-bbox="987 1205 1101 1247">-</td> <td data-bbox="1101 1205 1438 1247">FM1, FM2, FM3</td> </tr> <tr> <td data-bbox="423 1247 618 1289"></td> <td data-bbox="618 1247 727 1289">1</td> <td data-bbox="727 1247 857 1289">1</td> <td data-bbox="857 1247 987 1289">-</td> <td data-bbox="987 1247 1101 1289">-</td> <td data-bbox="1101 1247 1438 1289">FM1, FM2</td> </tr> <tr> <td data-bbox="423 1289 618 1331"></td> <td data-bbox="618 1289 727 1331">0</td> <td data-bbox="727 1289 857 1331">0</td> <td data-bbox="857 1289 987 1331">0</td> <td data-bbox="987 1289 1101 1331">-</td> <td data-bbox="1101 1289 1438 1331">FM1, FM2, FM3, MW1</td> </tr> <tr> <td data-bbox="423 1331 618 1373"></td> <td data-bbox="618 1331 727 1373">0</td> <td data-bbox="727 1331 857 1373">0</td> <td data-bbox="857 1331 987 1373">1</td> <td data-bbox="987 1331 1101 1373">-</td> <td data-bbox="1101 1331 1438 1373">FM1, FM2, FM3, MW1, MW2</td> </tr> <tr> <td data-bbox="423 1373 618 1415"></td> <td data-bbox="618 1373 727 1415">0</td> <td data-bbox="727 1373 857 1415">1</td> <td data-bbox="857 1373 987 1415">0</td> <td data-bbox="987 1373 1101 1415">-</td> <td data-bbox="1101 1373 1438 1415">FM1, FM2, MW1</td> </tr> <tr> <td data-bbox="423 1415 618 1457"></td> <td data-bbox="618 1415 727 1457">0</td> <td data-bbox="727 1415 857 1457">1</td> <td data-bbox="857 1415 987 1457">1</td> <td data-bbox="987 1415 1101 1457">-</td> <td data-bbox="1101 1415 1438 1457">FM1, FM2, MW1, MW2</td> </tr> </tbody> </table> <p>(1: Shorted by the diode; 0: Open; -: Don't care)</p>	Area	ENFM	DISFM3	ENMW2	DISLW	Reception band	Western Europe	1	0	-	-	FM1, FM2, FM3	Eastern Europe	1	1	-	-	FM1, FM2		0	0	0	0	FM1, FM2, FM3, MW1, LW		0	0	0	1	FM1, FM2, FM3, MW1		0	0	1	-	FM1, FM2, FM3, MW1, MW2		0	1	0	0	FM1, FM2, MW1, LW		0	1	0	1	FM1, FM2, MW1		0	1	1	-	FM1, FM2, MW1, MW2	The other areas	1	0	-	-	FM1, FM2, FM3		1	1	-	-	FM1, FM2		0	0	0	-	FM1, FM2, FM3, MW1		0	0	1	-	FM1, FM2, FM3, MW1, MW2		0	1	0	-	FM1, FM2, MW1		0	1	1	-	FM1, FM2, MW1, MW2
Area	ENFM	DISFM3	ENMW2	DISLW	Reception band																																																																																						
Western Europe	1	0	-	-	FM1, FM2, FM3																																																																																						
Eastern Europe	1	1	-	-	FM1, FM2																																																																																						
	0	0	0	0	FM1, FM2, FM3, MW1, LW																																																																																						
	0	0	0	1	FM1, FM2, FM3, MW1																																																																																						
	0	0	1	-	FM1, FM2, FM3, MW1, MW2																																																																																						
	0	1	0	0	FM1, FM2, MW1, LW																																																																																						
	0	1	0	1	FM1, FM2, MW1																																																																																						
	0	1	1	-	FM1, FM2, MW1, MW2																																																																																						
The other areas	1	0	-	-	FM1, FM2, FM3																																																																																						
	1	1	-	-	FM1, FM2																																																																																						
	0	0	0	-	FM1, FM2, FM3, MW1																																																																																						
	0	0	1	-	FM1, FM2, FM3, MW1, MW2																																																																																						
	0	1	0	-	FM1, FM2, MW1																																																																																						
	0	1	1	-	FM1, FM2, MW1, MW2																																																																																						

Initial setting diode	Description																																				
ENAMIF ENFMIF	<p>These switches specify whether to use the frequency counter to detect a broadcasting station, as follows:</p> <table border="1" data-bbox="345 260 1227 674"> <thead> <tr> <th data-bbox="345 260 505 331">ENFMIF</th> <th data-bbox="505 260 662 331">ENAMIF</th> <th data-bbox="662 260 820 331">Band</th> <th data-bbox="820 260 1227 331">Method to detect a station</th> </tr> </thead> <tbody> <tr> <td data-bbox="345 331 505 384">1</td> <td data-bbox="505 331 662 384">1</td> <td data-bbox="662 331 820 384">FM</td> <td data-bbox="820 331 1227 384">Frequency counter and SD method</td> </tr> <tr> <td data-bbox="345 384 505 436">1</td> <td data-bbox="505 384 662 436">1</td> <td data-bbox="662 384 820 436">MW, LW</td> <td data-bbox="820 384 1227 436">Frequency counter and SD method</td> </tr> <tr> <td data-bbox="345 436 505 489">1</td> <td data-bbox="505 436 662 489">0</td> <td data-bbox="662 436 820 489">FM</td> <td data-bbox="820 436 1227 489">Frequency counter and SD method</td> </tr> <tr> <td data-bbox="345 489 505 541">1</td> <td data-bbox="505 489 662 541">0</td> <td data-bbox="662 489 820 541">MW, LW</td> <td data-bbox="820 489 1227 541">SD method</td> </tr> <tr> <td data-bbox="345 541 505 594">0</td> <td data-bbox="505 541 662 594">1</td> <td data-bbox="662 541 820 594">FM</td> <td data-bbox="820 541 1227 594">SD method</td> </tr> <tr> <td data-bbox="345 594 505 646">0</td> <td data-bbox="505 594 662 646">1</td> <td data-bbox="662 594 820 646">MW, LW</td> <td data-bbox="820 594 1227 646">Frequency counter and SD method</td> </tr> <tr> <td data-bbox="345 646 505 699">0</td> <td data-bbox="505 646 662 699">0</td> <td data-bbox="662 646 820 699">FM</td> <td data-bbox="820 646 1227 699">SD method</td> </tr> <tr> <td data-bbox="345 699 505 751">0</td> <td data-bbox="505 699 662 751">0</td> <td data-bbox="662 699 820 751">MW, LW</td> <td data-bbox="820 699 1227 751">SD method</td> </tr> </tbody> </table> <p>(1: Shorted by the diode; 0: Open)</p>	ENFMIF	ENAMIF	Band	Method to detect a station	1	1	FM	Frequency counter and SD method	1	1	MW, LW	Frequency counter and SD method	1	0	FM	Frequency counter and SD method	1	0	MW, LW	SD method	0	1	FM	SD method	0	1	MW, LW	Frequency counter and SD method	0	0	FM	SD method	0	0	MW, LW	SD method
ENFMIF	ENAMIF	Band	Method to detect a station																																		
1	1	FM	Frequency counter and SD method																																		
1	1	MW, LW	Frequency counter and SD method																																		
1	0	FM	Frequency counter and SD method																																		
1	0	MW, LW	SD method																																		
0	1	FM	SD method																																		
0	1	MW, LW	Frequency counter and SD method																																		
0	0	FM	SD method																																		
0	0	MW, LW	SD method																																		
FAD_SEL	<p>This switch specifies whether to enable the electronic volume control fader function, as follows:</p> <table border="1" data-bbox="345 779 1352 1203"> <thead> <tr> <th data-bbox="345 779 467 825">FAD_SEL</th> <th data-bbox="467 779 1352 825">Description</th> </tr> </thead> <tbody> <tr> <td data-bbox="345 825 467 1014">0</td> <td data-bbox="467 825 1352 1014"> The fader function is enabled. Pressing the VOL_SEL key switches the electronic volume control mode as shown below. <div style="text-align: center; margin-top: 10px;">  </div> </td> </tr> <tr> <td data-bbox="345 1014 467 1203">1</td> <td data-bbox="467 1014 1352 1203"> The fader function is disabled. Pressing the VOL_SEL key switches the electronic volume control mode as shown below. <div style="text-align: center; margin-top: 10px;">  </div> </td> </tr> </tbody> </table> <p>(1: Shorted by the diode; 0: Open)</p>	FAD_SEL	Description	0	The fader function is enabled. Pressing the VOL_SEL key switches the electronic volume control mode as shown below. <div style="text-align: center; margin-top: 10px;">  </div>	1	The fader function is disabled. Pressing the VOL_SEL key switches the electronic volume control mode as shown below. <div style="text-align: center; margin-top: 10px;">  </div>																														
FAD_SEL	Description																																				
0	The fader function is enabled. Pressing the VOL_SEL key switches the electronic volume control mode as shown below. <div style="text-align: center; margin-top: 10px;">  </div>																																				
1	The fader function is disabled. Pressing the VOL_SEL key switches the electronic volume control mode as shown below. <div style="text-align: center; margin-top: 10px;">  </div>																																				
FLASH	<p>This switch specifies how a colon (:) is used in the clock display, as follows:</p> <table border="1" data-bbox="345 1308 816 1507"> <thead> <tr> <th data-bbox="345 1308 467 1354">FLASH</th> <th data-bbox="467 1308 816 1354">Colon (:) display</th> </tr> </thead> <tbody> <tr> <td data-bbox="345 1354 467 1402">0</td> <td data-bbox="467 1354 816 1402">Stays on.</td> </tr> <tr> <td data-bbox="345 1402 467 1507">1</td> <td data-bbox="467 1402 816 1507"> Blinks. <ul style="list-style-type: none"> ● Frequency: 1 Hz ● Duty cycle: 6 on and 4 off </td> </tr> </tbody> </table> <p>(1: Shorted by the diode; 0: Open)</p>	FLASH	Colon (:) display	0	Stays on.	1	Blinks. <ul style="list-style-type: none"> ● Frequency: 1 Hz ● Duty cycle: 6 on and 4 off 																														
FLASH	Colon (:) display																																				
0	Stays on.																																				
1	Blinks. <ul style="list-style-type: none"> ● Frequency: 1 Hz ● Duty cycle: 6 on and 4 off 																																				
IFAM	<p>This switch specifies the intermediate frequency for the AM band (MW and LW), as follows:</p> <table border="1" data-bbox="345 1608 816 1738"> <thead> <tr> <th data-bbox="345 1608 467 1654">IFAM</th> <th data-bbox="467 1608 816 1654">Intermediate frequency</th> </tr> </thead> <tbody> <tr> <td data-bbox="345 1654 467 1703">0</td> <td data-bbox="467 1654 816 1703">450 kHz</td> </tr> <tr> <td data-bbox="345 1703 467 1738">1</td> <td data-bbox="467 1703 816 1738">10.71 MHz</td> </tr> </tbody> </table> <p>(1: Shorted by the diode; 0: Open)</p>	IFAM	Intermediate frequency	0	450 kHz	1	10.71 MHz																														
IFAM	Intermediate frequency																																				
0	450 kHz																																				
1	10.71 MHz																																				

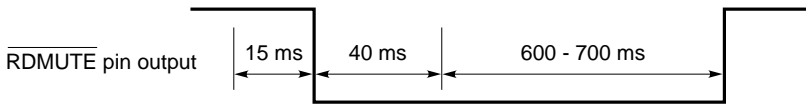
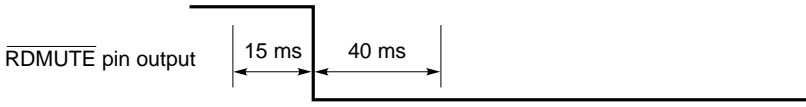
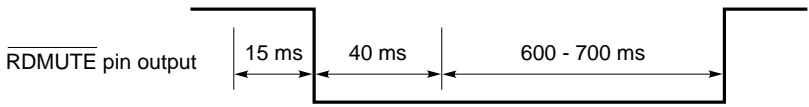
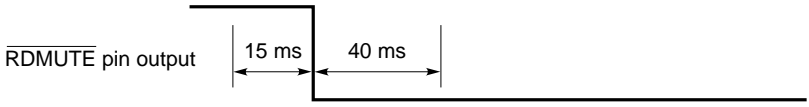
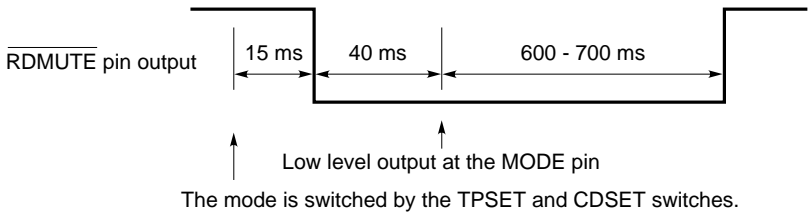
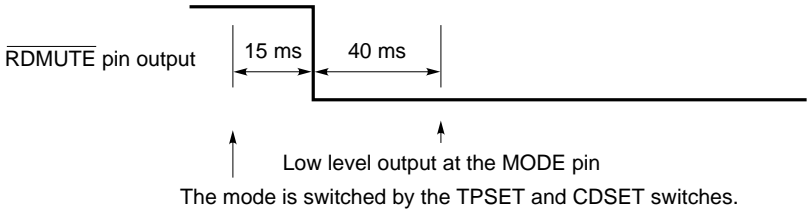
Initial setting diode	Description															
ILLA ILLB	<p>These switches set illumination control, as follows:</p> <table border="1" data-bbox="418 264 992 478"> <thead> <tr> <th>ILLA</th> <th>ILLB</th> <th>Function</th> </tr> </thead> <tbody> <tr> <td>0</td> <td>0</td> <td>Loudness function only</td> </tr> <tr> <td>0</td> <td>1</td> <td>Loudness/illumination functions</td> </tr> <tr> <td>1</td> <td>0</td> <td>Loudness/illumination functions</td> </tr> <tr> <td>1</td> <td>1</td> <td>Loudness function only</td> </tr> </tbody> </table> <p>(1: Shorted by the diode; 0: Open)</p>	ILLA	ILLB	Function	0	0	Loudness function only	0	1	Loudness/illumination functions	1	0	Loudness/illumination functions	1	1	Loudness function only
ILLA	ILLB	Function														
0	0	Loudness function only														
0	1	Loudness/illumination functions														
1	0	Loudness/illumination functions														
1	1	Loudness function only														
KTAPE	<p>This key specifies whether to assign the tape function (MTL) to the [M5] radio function key, as follows:</p> <table border="1" data-bbox="418 596 1032 726"> <thead> <tr> <th>KTAPE</th> <th>Function</th> </tr> </thead> <tbody> <tr> <td>0</td> <td>In tape mode, the [M5] key is not used for MTL.</td> </tr> <tr> <td>1</td> <td>In tape mode, the [M5] key is used for MTL.</td> </tr> </tbody> </table> <p>(1: Shorted by the diode; 0: Open)</p> <p>Regardless of the states of the KTAPE switch, the [M1] to [M6] keys are used to access a preset memory and enable or disable writing to it.</p> <ul style="list-style-type: none"> ● Radio-monitor tape mode ● Radio-monitor CD mode 	KTAPE	Function	0	In tape mode, the [M5] key is not used for MTL.	1	In tape mode, the [M5] key is used for MTL.									
KTAPE	Function															
0	In tape mode, the [M5] key is not used for MTL.															
1	In tape mode, the [M5] key is used for MTL.															
MUTESEL	<p>This switch specifies how the state of the $\overline{\text{RDMUTE}}$ pin output is to change in tape and CD modes, as follows:</p> <table border="1" data-bbox="418 989 1419 1619"> <thead> <tr> <th>MUTESEL</th> <th>$\overline{\text{RDMUTE}}$ pin output</th> </tr> </thead> <tbody> <tr> <td>1</td> <td> <p>The mute function is disabled in tape and CD modes.</p>  <p>When MUTESEL = 1, do not use the radio monitor function.</p> </td> </tr> <tr> <td>0</td> <td> <p>The mute function remains turned on in tape and CD modes.</p>  </td> </tr> </tbody> </table> <p>(1: Shorted by the diode; 0: Open)</p> <p>See Chapter 7 for details.</p>	MUTESEL	$\overline{\text{RDMUTE}}$ pin output	1	<p>The mute function is disabled in tape and CD modes.</p>  <p>When MUTESEL = 1, do not use the radio monitor function.</p>	0	<p>The mute function remains turned on in tape and CD modes.</p> 									
MUTESEL	$\overline{\text{RDMUTE}}$ pin output															
1	<p>The mute function is disabled in tape and CD modes.</p>  <p>When MUTESEL = 1, do not use the radio monitor function.</p>															
0	<p>The mute function remains turned on in tape and CD modes.</p> 															
MWS	<p>This switch specifies whether to enable the MW band stereo reception function, as follows:</p> <table border="1" data-bbox="418 1751 1427 1885"> <thead> <tr> <th>MWS</th> <th>Description</th> </tr> </thead> <tbody> <tr> <td>1</td> <td>The MW band stereo reception function is enabled.</td> </tr> <tr> <td>0</td> <td>The MW band stereo reception function is disabled.</td> </tr> </tbody> </table> <p>(1: Shorted by the diode; 0: Open)</p>	MWS	Description	1	The MW band stereo reception function is enabled.	0	The MW band stereo reception function is disabled.									
MWS	Description															
1	The MW band stereo reception function is enabled.															
0	The MW band stereo reception function is disabled.															

Initial setting diode	Description								
NOCLK	<p>This switch specifies whether a clock is available.</p> <table border="1" data-bbox="347 260 664 394"> <tr> <td>NOCLK</td> <td>Clock</td> </tr> <tr> <td>0</td> <td>Available</td> </tr> <tr> <td>1</td> <td>Unavailable</td> </tr> </table> <p>(1: Shorted by the diode; 0: Open)</p>	NOCLK	Clock	0	Available	1	Unavailable		
NOCLK	Clock								
0	Available								
1	Unavailable								
<p>PRIO1 PRIO2</p>	<p>These switches specify a privileged display. The term privileged display means the display which is resumed in five seconds after any other display is selected, if no key is pressed. The PRIO1 and PRIO2 switches can determine the privileged display only when the NOCLK initial setting diode = 0 (with a clock). If NOCLK = 1 (without a clock), the states of these switches are ignored.</p> <table border="1" data-bbox="347 600 1354 1478"> <thead> <tr> <th>PRIO1</th> <th>PRIO2</th> <th>Privileged display</th> <th>Description</th> </tr> </thead> <tbody> <tr> <td>0</td> <td>0</td> <td>None</td> <td> <p>Display switching occurs when the DISP key or a preset number key is pressed.</p> <ul style="list-style-type: none"> ○ In radio mode Each time the DISP key is pressed, switching occurs between the frequency and clock displays. Pressing a preset number key during clock display causes the frequency display to appear. ○ In tape mode Each time the DISP key is pressed, switching occurs between the "TRPE" and clock displays. ○ In CD mode Each time the DISP key is pressed, switching occurs between the "CD" and clock displays. ○ In radio-monitor tape mode Each time the DISP key is pressed, switching occurs among the "TRPE", frequency, and clock displays. Pressing the preset number key during "TRPE" or clock display causes the frequency display to appear. Radio-monitor tape mode begins with the frequency display. ○ In radio-monitor CD mode Each time the DISP key is pressed, switching occurs among the "CD", frequency, and clock displays. Pressing a preset number key during "CD" or clock display causes the frequency display to appear. Radio-monitor CD mode begins with the frequency display. </td> </tr> </tbody> </table> <p>(0: Open)</p>	PRIO1	PRIO2	Privileged display	Description	0	0	None	<p>Display switching occurs when the DISP key or a preset number key is pressed.</p> <ul style="list-style-type: none"> ○ In radio mode Each time the DISP key is pressed, switching occurs between the frequency and clock displays. Pressing a preset number key during clock display causes the frequency display to appear. ○ In tape mode Each time the DISP key is pressed, switching occurs between the "TRPE" and clock displays. ○ In CD mode Each time the DISP key is pressed, switching occurs between the "CD" and clock displays. ○ In radio-monitor tape mode Each time the DISP key is pressed, switching occurs among the "TRPE", frequency, and clock displays. Pressing the preset number key during "TRPE" or clock display causes the frequency display to appear. Radio-monitor tape mode begins with the frequency display. ○ In radio-monitor CD mode Each time the DISP key is pressed, switching occurs among the "CD", frequency, and clock displays. Pressing a preset number key during "CD" or clock display causes the frequency display to appear. Radio-monitor CD mode begins with the frequency display.
PRIO1	PRIO2	Privileged display	Description						
0	0	None	<p>Display switching occurs when the DISP key or a preset number key is pressed.</p> <ul style="list-style-type: none"> ○ In radio mode Each time the DISP key is pressed, switching occurs between the frequency and clock displays. Pressing a preset number key during clock display causes the frequency display to appear. ○ In tape mode Each time the DISP key is pressed, switching occurs between the "TRPE" and clock displays. ○ In CD mode Each time the DISP key is pressed, switching occurs between the "CD" and clock displays. ○ In radio-monitor tape mode Each time the DISP key is pressed, switching occurs among the "TRPE", frequency, and clock displays. Pressing the preset number key during "TRPE" or clock display causes the frequency display to appear. Radio-monitor tape mode begins with the frequency display. ○ In radio-monitor CD mode Each time the DISP key is pressed, switching occurs among the "CD", frequency, and clock displays. Pressing a preset number key during "CD" or clock display causes the frequency display to appear. Radio-monitor CD mode begins with the frequency display. 						

Initial setting diode	Description			
PRIO1 PRIO2	PRIO1	PRIO2	Privileged display	Description
	1	0	Frequency <i>CD</i> <i>TAPE</i>	<p>In 5 seconds after the DISP key is pressed to shift from the frequency, "<i>CD</i>", or "<i>TAPE</i>" display to the clock display, the previous display is resumed if no other key is pressed.</p> <ul style="list-style-type: none"> ○ In radio mode Usually the frequency display appears and remains. Pressing the DISP key causes the clock display to appear for 5 seconds. Pressing the DISP key or a preset number key within this 5-second period of the clock display resumes the frequency display. ○ In tape mode Usually the "<i>TAPE</i>" display appears and remains. Pressing the DISP key causes the clock display to appear for 5 seconds. Pressing the DISP key again within this 5-second period of clock display resumes the "<i>TAPE</i>" display. ○ In CD mode Usually the "<i>CD</i>" display appears and remains. Pressing the DISP key causes the clock display to appear for 5 seconds. Pressing the DISP key again within this 5-second period of the clock display resumes the "<i>CD</i>" display. ○ In radio-monitor tape mode Usually the "<i>TAPE</i>" display appears and remains. Pressing the DISP key causes the frequency display to appear for 5 seconds. Pressing the DISP key again within this 5-second period of the frequency display causes the clock display to appear. Pressing the DISP key again within this 5-second period of the clock display causes the "<i>TAPE</i>" display to appear. Pressing a preset number key during "<i>TAPE</i>" or clock display causes the frequency display to appear for 5 seconds. ○ In radio-monitor CD mode Usually the "<i>CD</i>" display appears and remains. Pressing the DISP key causes the frequency display to appear for 5 seconds. Pressing the DISP key again within this 5-second period of the frequency display causes the clock display to appear. Pressing the DISP key again within this 5-second period of the clock display causes the "<i>CD</i>" display to appear. Pressing a preset number key during "<i>CD</i>" or clock display causes the frequency display to appear for 5 seconds.
(1: Shorted by the diode; 0: Open)				

Initial setting diode	Description																									
PRIO1 PRIO2	<table border="1"> <thead> <tr> <th style="text-align: center;">PRIO1</th> <th style="text-align: center;">PRIO2</th> <th style="text-align: center;">Privileged display</th> <th style="text-align: center;">Description</th> </tr> </thead> <tbody> <tr> <td style="text-align: center;">0</td> <td style="text-align: center;">1</td> <td style="text-align: center;">Clock</td> <td> <p>The clock display has precedence over the other displays.</p> <ul style="list-style-type: none"> ○ In radio mode Usually the clock display appears and remains. Pressing the DISP key causes the frequency display to appear for 5 seconds. Pressing the DISP key again within this 5-second period of frequency display resumes the clock display. ○ In tape mode Usually the clock display appears and remains. Pressing the DISP key causes the "TAPPE" display to appear for 5 seconds. Pressing the DISP key again within this 5-second period of "TAPPE" display resumes the clock display. ○ In CD mode Usually the clock display appears and remains. Pressing the DISP key causes the "CD" display to appear for 5 seconds. Pressing the DISP key again within this 5-second period of the "CD" display resumes the clock display. ○ In radio-monitor tape mode Usually the clock display appears and remains. Pressing the DISP key causes the "TAPPE" display to appear for 5 seconds. Pressing the DISP key again within this 5-second period of the "TAPPE" display causes the frequency display to appear. Pressing the DISP key again within this 5-second period of the frequency display causes the clock display to appear. Pressing a preset number key during "TAPPE" or clock display causes the frequency display to appear for 5 seconds. ○ In radio-monitor CD mode Usually the clock display appears and remains. Pressing the DISP key causes the "CD" display to appear for 5 seconds. Pressing the DISP key again within this 5-second period of the "CD" display causes the frequency display to appear. Pressing the DISP key again within this 5-second period of the frequency display causes the clock display to appear. Pressing a preset number key during "CD" or clock display causes the frequency display to appear for 5 seconds. </td> </tr> <tr> <td style="text-align: center;">1</td> <td style="text-align: center;">1</td> <td style="text-align: center;">-</td> <td style="text-align: center;">Do not select this mode.</td> </tr> </tbody> </table>	PRIO1	PRIO2	Privileged display	Description	0	1	Clock	<p>The clock display has precedence over the other displays.</p> <ul style="list-style-type: none"> ○ In radio mode Usually the clock display appears and remains. Pressing the DISP key causes the frequency display to appear for 5 seconds. Pressing the DISP key again within this 5-second period of frequency display resumes the clock display. ○ In tape mode Usually the clock display appears and remains. Pressing the DISP key causes the "TAPPE" display to appear for 5 seconds. Pressing the DISP key again within this 5-second period of "TAPPE" display resumes the clock display. ○ In CD mode Usually the clock display appears and remains. Pressing the DISP key causes the "CD" display to appear for 5 seconds. Pressing the DISP key again within this 5-second period of the "CD" display resumes the clock display. ○ In radio-monitor tape mode Usually the clock display appears and remains. Pressing the DISP key causes the "TAPPE" display to appear for 5 seconds. Pressing the DISP key again within this 5-second period of the "TAPPE" display causes the frequency display to appear. Pressing the DISP key again within this 5-second period of the frequency display causes the clock display to appear. Pressing a preset number key during "TAPPE" or clock display causes the frequency display to appear for 5 seconds. ○ In radio-monitor CD mode Usually the clock display appears and remains. Pressing the DISP key causes the "CD" display to appear for 5 seconds. Pressing the DISP key again within this 5-second period of the "CD" display causes the frequency display to appear. Pressing the DISP key again within this 5-second period of the frequency display causes the clock display to appear. Pressing a preset number key during "CD" or clock display causes the frequency display to appear for 5 seconds. 	1	1	-	Do not select this mode.	<p>(1: Shorted by the diode; 0: Open)</p> <p>If a clock is unavailable (NOCLK = 1), one of the displays listed below appears depending on what the current mode is, regardless of the states of the PRIO1 and PRIO2 switches. The DISP key is ineffective.</p> <table border="1" style="margin-left: auto; margin-right: auto;"> <thead> <tr> <th style="text-align: center;">Mode</th> <th style="text-align: center;">Display</th> </tr> </thead> <tbody> <tr> <td>Radio mode</td> <td style="text-align: center;">Frequency</td> </tr> <tr> <td>Tape mode</td> <td style="text-align: center;">TAPPE</td> </tr> <tr> <td>CD mode</td> <td style="text-align: center;">CD</td> </tr> <tr> <td>● Radio-monitor tape mode ● Radio-monitor CD mode</td> <td style="text-align: center;">Frequency</td> </tr> </tbody> </table>			Mode	Display	Radio mode	Frequency	Tape mode	TAPPE	CD mode	CD	● Radio-monitor tape mode ● Radio-monitor CD mode	Frequency
PRIO1	PRIO2	Privileged display	Description																							
0	1	Clock	<p>The clock display has precedence over the other displays.</p> <ul style="list-style-type: none"> ○ In radio mode Usually the clock display appears and remains. Pressing the DISP key causes the frequency display to appear for 5 seconds. Pressing the DISP key again within this 5-second period of frequency display resumes the clock display. ○ In tape mode Usually the clock display appears and remains. Pressing the DISP key causes the "TAPPE" display to appear for 5 seconds. Pressing the DISP key again within this 5-second period of "TAPPE" display resumes the clock display. ○ In CD mode Usually the clock display appears and remains. Pressing the DISP key causes the "CD" display to appear for 5 seconds. Pressing the DISP key again within this 5-second period of the "CD" display resumes the clock display. ○ In radio-monitor tape mode Usually the clock display appears and remains. Pressing the DISP key causes the "TAPPE" display to appear for 5 seconds. Pressing the DISP key again within this 5-second period of the "TAPPE" display causes the frequency display to appear. Pressing the DISP key again within this 5-second period of the frequency display causes the clock display to appear. Pressing a preset number key during "TAPPE" or clock display causes the frequency display to appear for 5 seconds. ○ In radio-monitor CD mode Usually the clock display appears and remains. Pressing the DISP key causes the "CD" display to appear for 5 seconds. Pressing the DISP key again within this 5-second period of the "CD" display causes the frequency display to appear. Pressing the DISP key again within this 5-second period of the frequency display causes the clock display to appear. Pressing a preset number key during "CD" or clock display causes the frequency display to appear for 5 seconds. 																							
1	1	-	Do not select this mode.																							
Mode	Display																									
Radio mode	Frequency																									
Tape mode	TAPPE																									
CD mode	CD																									
● Radio-monitor tape mode ● Radio-monitor CD mode	Frequency																									

Initial setting diode	Description															
VKYSEL	<p>This switch specifies what keys are used for volume control in each electronic volume control mode, as follows:</p> <table border="1" data-bbox="418 289 1425 491"> <thead> <tr> <th data-bbox="418 289 537 331">VKYSEL</th> <th data-bbox="537 289 1425 331">Description</th> </tr> </thead> <tbody> <tr> <td data-bbox="418 331 537 415">0</td> <td data-bbox="537 331 1425 415">The VOL UP and VOL DWN keys are used for volume control in each electronic volume control mode.</td> </tr> <tr> <td data-bbox="418 415 537 491">1</td> <td data-bbox="537 415 1425 491">The MAN UP and MAN DWN keys are used for volume control in each electronic volume control mode. The VOL UP or VOL DWN key is unusable for volume control.</td> </tr> </tbody> </table> <p>(1: Shorted by the diode; 0: Open)</p>	VKYSEL	Description	0	The VOL UP and VOL DWN keys are used for volume control in each electronic volume control mode.	1	The MAN UP and MAN DWN keys are used for volume control in each electronic volume control mode. The VOL UP or VOL DWN key is unusable for volume control.									
VKYSEL	Description															
0	The VOL UP and VOL DWN keys are used for volume control in each electronic volume control mode.															
1	The MAN UP and MAN DWN keys are used for volume control in each electronic volume control mode. The VOL UP or VOL DWN key is unusable for volume control.															
VOLATT_H VOLATT_L	<p>These switches specify the gain of the electronic volume control, as follows:</p> <table border="1" data-bbox="418 600 1425 831"> <thead> <tr> <th data-bbox="418 600 756 642">VOLATT_H</th> <th data-bbox="756 600 1094 642">VOLATT_L</th> <th data-bbox="1094 600 1425 642">Gain</th> </tr> </thead> <tbody> <tr> <td data-bbox="418 642 756 684">0</td> <td data-bbox="756 642 1094 684">0</td> <td data-bbox="1094 642 1425 684">11.25 dB</td> </tr> <tr> <td data-bbox="418 684 756 726">0</td> <td data-bbox="756 684 1094 726">1</td> <td data-bbox="1094 684 1425 726">7.5 dB</td> </tr> <tr> <td data-bbox="418 726 756 768">1</td> <td data-bbox="756 726 1094 768">0</td> <td data-bbox="1094 726 1425 768">0 dB</td> </tr> <tr> <td data-bbox="418 768 756 831">1</td> <td data-bbox="756 768 1094 831">1</td> <td data-bbox="1094 768 1425 831">3.75 dB</td> </tr> </tbody> </table>	VOLATT_H	VOLATT_L	Gain	0	0	11.25 dB	0	1	7.5 dB	1	0	0 dB	1	1	3.75 dB
VOLATT_H	VOLATT_L	Gain														
0	0	11.25 dB														
0	1	7.5 dB														
1	0	0 dB														
1	1	3.75 dB														

2.6.2 Alternation or transistor switch

In the following table, a statement that a switch is on (off) means that a high (low) level is input.

Alternation/ transistor switch	Description													
CDSET	This switch selects CD mode. It is effective only when the CE pins is at a high level. Setting this switch to on selects CD mode.													
DTH	This is the input switch to specify whether the detachable panel is attached. When this switch is off, it indicates that the panel is detached.													
FF	<p>This is the fast forward signal input switch for tape mode. The tape run direction indicator (◀▶) may light depending on the state of the RL switch as listed below.</p> <table border="1"> <thead> <tr> <th>FF</th> <th>RL</th> <th>Indicator</th> </tr> </thead> <tbody> <tr> <td rowspan="2">0</td> <td>0</td> <td>◀▶</td> </tr> <tr> <td>1</td> <td>▶◀</td> </tr> <tr> <td rowspan="2">1</td> <td>0</td> <td>◀▶</td> </tr> <tr> <td>1</td> <td>▶◀</td> </tr> </tbody> </table> <p>(▶ : Does not light ◀ : Lights ▶◀ : Blinks (at 2.5 Hz)) 0 : Off 1 : On</p>	FF	RL	Indicator	0	0	◀▶	1	▶◀	1	0	◀▶	1	▶◀
FF	RL	Indicator												
0	0	◀▶												
	1	▶◀												
1	0	◀▶												
	1	▶◀												
RDSET	This switch selects radio mode. It is effective only when the CE pin is at a high level. If both CDSET and TPSET switches are off, setting the RDSET switch to on selects radio mode.													
RL	This is the forward run signal input switch for tape mode. The tape run direction indicator (◀▶) is controlled according to the state of the FF switch. See the description of the FF switch for the state of the indicator.													
ST	This switch is a stereo signal input switch for radio mode. For the FM band in radio mode, setting this switch to on turns on the "ST" display. If the stereo reception function is available for the MW band (initial setting diode MWS = 1), setting the ST switch to on with the MW band selected turns on the "ST" display. However, the display is turned off in the monaural state.													
TPSET	This switch selects tape mode. It is effective only when the CE pins is at a high level. If the CDSET switch is off, setting the TPSET switch to on selects tape mode.													

2.6.3 Momentary keys

The functions of the momentary keys are summarized below (in alphabetical order).

Momentary key	Description
<p>ALARM</p>	<p>This key can be used only for setting alarm mode. This key is effective when the IGNITION pin is at the low level and DISALARM initial setting diode = 0. See Chapter 3 for details.</p>
<p>BAND</p>	<p>The BAND key is used to switch the reception band. This key is effective when the current mode is radio, radio-monitor tape, or radio-monitor CD mode. When the key is pressed, the reception band is switched sequentially as follows.</p> <div style="text-align: center; border: 1px solid black; padding: 5px; width: fit-content; margin: 10px auto;"> <p>→ FM1 → FM2 → FM3 → MW1 → MW2 → LW</p> </div> <p>However, inhibited bands are skipped. They are specified by the AREA1, AREA2, and AREA3 initial setting diodes (to specify reception areas) and the DISFM3, DISLW, ENFM, and ENMW2 initial setting diodes (to specify reception bands). The band display and last channel vary during band switching within the same type of band (FM1 → FM2 → FM3, MW1 → MW2). The BAND key becomes ineffective in tape and CD modes.</p>
<p>CD</p>	<p>Each time the CD key is pressed, the output of the CDOUT pin (pin 45) is inverted. Using the CDOUT output makes it possible to implement an application such as described below: Turning on/off a transistor switch connected to the CDSET pin according to the CDOUT output can switch on/off the CD mode according to the state of the CD key.</p> <div style="text-align: center; margin-top: 20px;"> <p>The diagram shows a circuit where the CDOUT pin (pin 45) is connected to an inverter. The output of the inverter is connected to the base of a transistor labeled KS7. The emitter of the transistor is connected to ground. The collector of the transistor is connected to a diode labeled K1, which is also connected to a resistor leading to the VDD supply.</p> </div>

Momentary key	Description																																
DISP	<p>The DISP key is used to switch the display. It is effective when NOCLK initial setting diode = 0 (with a clock).</p> <p>Display switching occurs as follows:</p> <p>(1) In radio mode</p> <p>Each time the key is pressed, the display switches between the frequency and clock.</p> <p>The DISP key is ineffective during seek-scanning and auto-preset scanning.</p> <p>The operation depends on the states of the PRIO1 and PRIO2 initial setting diodes as follows:</p> <table border="1" style="width: 100%; border-collapse: collapse;"> <thead> <tr> <th style="width: 10%;">PRIO1</th> <th style="width: 10%;">PRIO2</th> <th style="width: 15%;">Privileged display</th> <th>Description</th> </tr> </thead> <tbody> <tr> <td style="text-align: center;">0</td> <td style="text-align: center;">0</td> <td style="text-align: center;">None</td> <td>Each time the DISP key is pressed, the display switches between the frequency and clock.</td> </tr> <tr> <td style="text-align: center;">1</td> <td style="text-align: center;">0</td> <td style="text-align: center;">Frequency display</td> <td>Pressing the DISP key during frequency display causes the clock display to appear for 5 seconds. Pressing the DISP key during the 5-second period of clock display causes the frequency display to appear again.</td> </tr> <tr> <td style="text-align: center;">0</td> <td style="text-align: center;">1</td> <td style="text-align: center;">Clock display</td> <td>Pressing the DISP key during clock display causes the frequency display to appear for 5 seconds. Pressing the DISP key during the 5-second period of frequency display causes the clock display to appear again.</td> </tr> </tbody> </table> <p style="text-align: center;">(1: Shorted by the diode; 0: Open)</p> <p>When radio mode is selected, the display begins with the frequency.</p> <p>(2) In tape mode</p> <p>Each time the DISP key is pressed, the display switches between "TAPE" and the clock.</p> <p>The operation depends on the states of the PRIO1 and PRIO2 initial setting diodes as follows:</p> <table border="1" style="width: 100%; border-collapse: collapse;"> <thead> <tr> <th style="width: 10%;">PRIO1</th> <th style="width: 10%;">PRIO2</th> <th style="width: 15%;">Privileged display</th> <th>Description</th> </tr> </thead> <tbody> <tr> <td style="text-align: center;">0</td> <td style="text-align: center;">0</td> <td style="text-align: center;">None</td> <td>Each time the DISP key is pressed, the display switches between the frequency and clock.</td> </tr> <tr> <td style="text-align: center;">1</td> <td style="text-align: center;">0</td> <td style="text-align: center;">"TAPE" display</td> <td>Pressing the DISP key during "TAPE" display causes the clock display to appear for 5 seconds. Pressing the DISP key during the 5-second period of clock display causes the "TAPE" display to appear again.</td> </tr> <tr> <td style="text-align: center;">0</td> <td style="text-align: center;">1</td> <td style="text-align: center;">Clock display</td> <td>Pressing the DISP key during clock display causes the "TAPE" display to appear for 5 seconds. Pressing the DISP key during the 5-second period of "TAPE" display causes the clock display to appear again.</td> </tr> </tbody> </table> <p style="text-align: center;">(1: Shorted by the diode; 0: Open)</p> <p>When radio mode is selected, the display begins with the "TAPE" display.</p>	PRIO1	PRIO2	Privileged display	Description	0	0	None	Each time the DISP key is pressed, the display switches between the frequency and clock.	1	0	Frequency display	Pressing the DISP key during frequency display causes the clock display to appear for 5 seconds. Pressing the DISP key during the 5-second period of clock display causes the frequency display to appear again.	0	1	Clock display	Pressing the DISP key during clock display causes the frequency display to appear for 5 seconds. Pressing the DISP key during the 5-second period of frequency display causes the clock display to appear again.	PRIO1	PRIO2	Privileged display	Description	0	0	None	Each time the DISP key is pressed, the display switches between the frequency and clock.	1	0	"TAPE" display	Pressing the DISP key during "TAPE" display causes the clock display to appear for 5 seconds. Pressing the DISP key during the 5-second period of clock display causes the "TAPE" display to appear again.	0	1	Clock display	Pressing the DISP key during clock display causes the "TAPE" display to appear for 5 seconds. Pressing the DISP key during the 5-second period of "TAPE" display causes the clock display to appear again.
PRIO1	PRIO2	Privileged display	Description																														
0	0	None	Each time the DISP key is pressed, the display switches between the frequency and clock.																														
1	0	Frequency display	Pressing the DISP key during frequency display causes the clock display to appear for 5 seconds. Pressing the DISP key during the 5-second period of clock display causes the frequency display to appear again.																														
0	1	Clock display	Pressing the DISP key during clock display causes the frequency display to appear for 5 seconds. Pressing the DISP key during the 5-second period of frequency display causes the clock display to appear again.																														
PRIO1	PRIO2	Privileged display	Description																														
0	0	None	Each time the DISP key is pressed, the display switches between the frequency and clock.																														
1	0	"TAPE" display	Pressing the DISP key during "TAPE" display causes the clock display to appear for 5 seconds. Pressing the DISP key during the 5-second period of clock display causes the "TAPE" display to appear again.																														
0	1	Clock display	Pressing the DISP key during clock display causes the "TAPE" display to appear for 5 seconds. Pressing the DISP key during the 5-second period of "TAPE" display causes the clock display to appear again.																														

Momentary key	Description																																
DISP	<p>(3) In CD mode Each time the DISP key is pressed, the display switches between "CD" and the clock. The operation depends on the states of the PRIO1 and PRIO2 initial setting diodes as follows:</p> <table border="1" style="width: 100%; border-collapse: collapse;"> <thead> <tr> <th style="text-align: center;">PRIO1</th> <th style="text-align: center;">PRIO2</th> <th style="text-align: center;">Privileged display</th> <th style="text-align: center;">Description</th> </tr> </thead> <tbody> <tr> <td style="text-align: center;">0</td> <td style="text-align: center;">0</td> <td style="text-align: center;">None</td> <td>Each time the DISP key is pressed, the display switches between "CD" and clock.</td> </tr> <tr> <td style="text-align: center;">1</td> <td style="text-align: center;">0</td> <td style="text-align: center;">"CD" display</td> <td>Pressing the DISP key during "CD" display causes the clock display to appear for 5 seconds. Pressing the DISP key during the 5-second period of clock display causes the "CD" display to appear again.</td> </tr> <tr> <td style="text-align: center;">0</td> <td style="text-align: center;">1</td> <td style="text-align: center;">Clock display</td> <td>Pressing the DISP key during clock display causes the "CD" display to appear for 5 seconds. Pressing the DISP key during the 5-second period of "CD" display causes the clock display to appear again.</td> </tr> </tbody> </table> <p>(1: Shorted by the diode; 0: Open) When CD mode is selected, the display begins with the "CD".</p> <p>(4) In radio-monitor tape mode Each time the DISP key is pressed, the display switches among "TAPE", frequency, and clock. The operation depends on the states of the PRIO1 and PRIO2 initial setting diodes as follows:</p> <table border="1" style="width: 100%; border-collapse: collapse;"> <thead> <tr> <th style="text-align: center;">PRIO1</th> <th style="text-align: center;">PRIO2</th> <th style="text-align: center;">Privileged display</th> <th style="text-align: center;">Description</th> </tr> </thead> <tbody> <tr> <td style="text-align: center;">0</td> <td style="text-align: center;">0</td> <td style="text-align: center;">None</td> <td>Each time the DISP key is pressed, the display is toggled as follows: <div style="text-align: center; border: 1px solid black; padding: 5px; width: fit-content; margin: 5px auto;"> → "TAPE" → frequency → clock </div> </td> </tr> <tr> <td style="text-align: center;">1</td> <td style="text-align: center;">0</td> <td style="text-align: center;">"TAPE" display</td> <td>Each time the DISP key is pressed, the display is toggled as follows: <div style="text-align: center; border: 1px solid black; padding: 5px; width: fit-content; margin: 5px auto;"> → "TAPE" → frequency → clock </div> <p>If no key is pressed during frequency or clock display, the "TAPE" display appears again after 5 seconds.</p> </td> </tr> <tr> <td style="text-align: center;">0</td> <td style="text-align: center;">1</td> <td style="text-align: center;">Clock display</td> <td>Each time the DISP key is pressed, the display is toggled as follows: <div style="text-align: center; border: 1px solid black; padding: 5px; width: fit-content; margin: 5px auto;"> → "TAPE" → frequency → clock </div> <p>If no key is pressed during frequency or "TAPE" display, the clock display appears again after 5 seconds.</p> </td> </tr> </tbody> </table> <p>(1: Shorted by the diode; 0: Open) When radio-monitor tape mode is selected, the display begins with the frequency.</p>	PRIO1	PRIO2	Privileged display	Description	0	0	None	Each time the DISP key is pressed, the display switches between "CD" and clock.	1	0	"CD" display	Pressing the DISP key during "CD" display causes the clock display to appear for 5 seconds. Pressing the DISP key during the 5-second period of clock display causes the "CD" display to appear again.	0	1	Clock display	Pressing the DISP key during clock display causes the "CD" display to appear for 5 seconds. Pressing the DISP key during the 5-second period of "CD" display causes the clock display to appear again.	PRIO1	PRIO2	Privileged display	Description	0	0	None	Each time the DISP key is pressed, the display is toggled as follows: <div style="text-align: center; border: 1px solid black; padding: 5px; width: fit-content; margin: 5px auto;"> → "TAPE" → frequency → clock </div>	1	0	"TAPE" display	Each time the DISP key is pressed, the display is toggled as follows: <div style="text-align: center; border: 1px solid black; padding: 5px; width: fit-content; margin: 5px auto;"> → "TAPE" → frequency → clock </div> <p>If no key is pressed during frequency or clock display, the "TAPE" display appears again after 5 seconds.</p>	0	1	Clock display	Each time the DISP key is pressed, the display is toggled as follows: <div style="text-align: center; border: 1px solid black; padding: 5px; width: fit-content; margin: 5px auto;"> → "TAPE" → frequency → clock </div> <p>If no key is pressed during frequency or "TAPE" display, the clock display appears again after 5 seconds.</p>
PRIO1	PRIO2	Privileged display	Description																														
0	0	None	Each time the DISP key is pressed, the display switches between "CD" and clock.																														
1	0	"CD" display	Pressing the DISP key during "CD" display causes the clock display to appear for 5 seconds. Pressing the DISP key during the 5-second period of clock display causes the "CD" display to appear again.																														
0	1	Clock display	Pressing the DISP key during clock display causes the "CD" display to appear for 5 seconds. Pressing the DISP key during the 5-second period of "CD" display causes the clock display to appear again.																														
PRIO1	PRIO2	Privileged display	Description																														
0	0	None	Each time the DISP key is pressed, the display is toggled as follows: <div style="text-align: center; border: 1px solid black; padding: 5px; width: fit-content; margin: 5px auto;"> → "TAPE" → frequency → clock </div>																														
1	0	"TAPE" display	Each time the DISP key is pressed, the display is toggled as follows: <div style="text-align: center; border: 1px solid black; padding: 5px; width: fit-content; margin: 5px auto;"> → "TAPE" → frequency → clock </div> <p>If no key is pressed during frequency or clock display, the "TAPE" display appears again after 5 seconds.</p>																														
0	1	Clock display	Each time the DISP key is pressed, the display is toggled as follows: <div style="text-align: center; border: 1px solid black; padding: 5px; width: fit-content; margin: 5px auto;"> → "TAPE" → frequency → clock </div> <p>If no key is pressed during frequency or "TAPE" display, the clock display appears again after 5 seconds.</p>																														

Momentary key	Description																
DISP	<p>(5) In radio-monitor CD mode</p> <p>Each time the DISP key is pressed, the display switches among "CD", frequency, and clock. The operation depends on the states of the PRIO1 and PRIO2 initial setting diodes as follows:</p> <table border="1" style="width: 100%; border-collapse: collapse;"> <thead> <tr> <th style="width: 10%;">PRIO1</th> <th style="width: 10%;">PRIO2</th> <th style="width: 15%;">Privileged display</th> <th>Description</th> </tr> </thead> <tbody> <tr> <td style="text-align: center;">0</td> <td style="text-align: center;">0</td> <td style="text-align: center;">None</td> <td> Each time the DISP key is pressed, the display is toggled as follows: <div style="text-align: center; border: 1px solid black; padding: 5px; width: fit-content; margin: 5px auto;"> → "CD" → frequency → clock → </div> </td> </tr> <tr> <td style="text-align: center;">1</td> <td style="text-align: center;">0</td> <td style="text-align: center;">"CD" display</td> <td> Each time the DISP key is pressed, the display is toggled as follows: <div style="text-align: center; border: 1px solid black; padding: 5px; width: fit-content; margin: 5px auto;"> → "CD" → frequency → clock → </div> If no key is pressed during frequency or clock display, the "CD" display appears again after 5 seconds. </td> </tr> <tr> <td style="text-align: center;">0</td> <td style="text-align: center;">1</td> <td style="text-align: center;">Clock display</td> <td> Each time the DISP key is pressed, the display is toggled as follows: <div style="text-align: center; border: 1px solid black; padding: 5px; width: fit-content; margin: 5px auto;"> → "CD" → frequency → clock → </div> If no key is pressed during frequency or "CD" display, the clock display appears again after 5 seconds. </td> </tr> </tbody> </table> <p style="margin-top: 10px;">(1: Shorted by the diode; 0: Open)</p> <p>When radio-monitor CD mode is selected, the display begins with the frequency.</p> <p>(6) During clock display</p> <p>The DISP key is used to adjust the clock. The minute and hour displays are adjusted by pressing the MAN UP and MAN DWN keys with the DISP key held pressed, as follows:</p> <ul style="list-style-type: none"> ● Hour adjustment Each time the MAN DWN key is pressed, the hour display is incremented by one. Keeping the key pressed for at least 0.5 seconds increments the hour display at a rate of four per second (one per 250 ms). The continuous increment continues until the key is released. The minute display, second count, or pointer movement is not affected. ● Minute adjustment Each time the MAN UP key is pressed, the minute display is incremented by one. Keeping the key pressed for at least 0.5 seconds increments the minute display at a rate of eight per second (one per 125 ms). The continuous increment continues until the key is released. No carry-over occurs to the hour display. The second count is reset to 0 at each adjustment. 	PRIO1	PRIO2	Privileged display	Description	0	0	None	Each time the DISP key is pressed, the display is toggled as follows: <div style="text-align: center; border: 1px solid black; padding: 5px; width: fit-content; margin: 5px auto;"> → "CD" → frequency → clock → </div>	1	0	"CD" display	Each time the DISP key is pressed, the display is toggled as follows: <div style="text-align: center; border: 1px solid black; padding: 5px; width: fit-content; margin: 5px auto;"> → "CD" → frequency → clock → </div> If no key is pressed during frequency or clock display, the "CD" display appears again after 5 seconds.	0	1	Clock display	Each time the DISP key is pressed, the display is toggled as follows: <div style="text-align: center; border: 1px solid black; padding: 5px; width: fit-content; margin: 5px auto;"> → "CD" → frequency → clock → </div> If no key is pressed during frequency or "CD" display, the clock display appears again after 5 seconds.
PRIO1	PRIO2	Privileged display	Description														
0	0	None	Each time the DISP key is pressed, the display is toggled as follows: <div style="text-align: center; border: 1px solid black; padding: 5px; width: fit-content; margin: 5px auto;"> → "CD" → frequency → clock → </div>														
1	0	"CD" display	Each time the DISP key is pressed, the display is toggled as follows: <div style="text-align: center; border: 1px solid black; padding: 5px; width: fit-content; margin: 5px auto;"> → "CD" → frequency → clock → </div> If no key is pressed during frequency or clock display, the "CD" display appears again after 5 seconds.														
0	1	Clock display	Each time the DISP key is pressed, the display is toggled as follows: <div style="text-align: center; border: 1px solid black; padding: 5px; width: fit-content; margin: 5px auto;"> → "CD" → frequency → clock → </div> If no key is pressed during frequency or "CD" display, the clock display appears again after 5 seconds.														

Momentary key	Description															
<div style="border: 1px solid black; padding: 2px; width: fit-content; margin-bottom: 5px;">DSP</div>	<p>Pressing the DSP key switches the output of the DSP1 and DSP2 pins, as follows. The initial value is NORMAL. While the power is off, the output mode is NORMAL.</p> <table border="1" data-bbox="420 296 992 510" style="margin: 10px auto;"> <thead> <tr> <th>DSP1</th> <th>DSP2</th> <th>Output mode</th> </tr> </thead> <tbody> <tr> <td>0</td> <td>0</td> <td>NORMAL</td> </tr> <tr> <td>0</td> <td>1</td> <td>CLASSIC</td> </tr> <tr> <td>1</td> <td>0</td> <td>ROCK</td> </tr> <tr> <td>1</td> <td>1</td> <td>POP</td> </tr> </tbody> </table> <p>(1: Shorted by the diode; 1: Open) In radio, tape, and CD modes, the output mode which was used last is recorded in memory for each mode.</p> <p>Example</p> <div style="text-align: center; margin: 10px 0;"> Radio mode → Tape mode → Radio mode (CLASSIC) (ROCK) (CLASSIC) Last state ————— ↑ </div> <p>In radio, tape, or CD mode, "NORMAL," "CLASSIC," "ROCK," or "POP" is displayed, according to the output mode.</p>	DSP1	DSP2	Output mode	0	0	NORMAL	0	1	CLASSIC	1	0	ROCK	1	1	POP
DSP1	DSP2	Output mode														
0	0	NORMAL														
0	1	CLASSIC														
1	0	ROCK														
1	1	POP														
<div style="border: 1px solid black; padding: 2px; width: fit-content; margin-bottom: 5px;">LOUD/ ILLUMI- NATION</div>	<p>Key for switching LOUD (loudness) control and illumination control.</p> <p>(1) Loudness control</p> <p>It is effective in radio, tape, and CD modes. Each time the LOUD/ILLUMINATION key is pressed, the control of loudness and the electronic volume control loudness function are switched on or off. The following table lists the states of loudness, "LOUD" display, the LOUD pin output, and the electronic volume control IC.</p> <table border="1" data-bbox="420 1062 1222 1230" style="margin: 10px auto;"> <thead> <tr> <th>Loudness state</th> <th>"LOUD" display</th> <th>LOUD pin</th> <th>Electronic volume control IC state</th> </tr> </thead> <tbody> <tr> <td>ON</td> <td>Lights</td> <td>High level</td> <td>Loudness ON mode^{Note}</td> </tr> <tr> <td>OFF</td> <td>Does not light</td> <td>Low level</td> <td>Loudness OFF mode^{Note}</td> </tr> </tbody> </table> <p>Switching radio, tape, or CD mode does not affect the state of loudness.</p> <p>Note In loudness ON mode, set the gain of the electronic volume to +7.5 dB. In loudness OFF mode, set the gain of the electronic volume to 0 dB.</p> <p>(2) Illumination control</p> <p>Illumination control is effective in radio, tape, and CD modes. When this key is pressed and held down for two seconds or more, the previous ILLUMI output is inverted. The initial value is low-level output. The illumination control, however, can be enabled or disabled by using the ILLA and ILLB initial setting diodes (see Section 2.6.1).</p>	Loudness state	"LOUD" display	LOUD pin	Electronic volume control IC state	ON	Lights	High level	Loudness ON mode ^{Note}	OFF	Does not light	Low level	Loudness OFF mode ^{Note}			
Loudness state	"LOUD" display	LOUD pin	Electronic volume control IC state													
ON	Lights	High level	Loudness ON mode ^{Note}													
OFF	Does not light	Low level	Loudness OFF mode ^{Note}													

Momentary key	Description						
<table border="1"> <tr><td>M1</td></tr> <tr><td>M2</td></tr> <tr><td>M3</td></tr> <tr><td>M4</td></tr> <tr><td>M5</td></tr> <tr><td>M6</td></tr> </table>	M1	M2	M3	M4	M5	M6	<p>In radio mode, these keys are used to access a preset memory and control whether to enable writing to it. In tape mode, the M5 keys are used for a tape function (MTL) key depending on the settings of the KTAPE initial setting diode.</p> <p>(1) In radio, radio-monitor tape, and radio-monitor CD modes</p> <p>The M1 to M6 keys are used to access a preset memory and control whether to enable writing to it. Each key can be set to the FM1, FM2, FM3, MW1, MW2 and LW bands (up to six bands) separately.</p> <p>The functions of these keys are as follows:</p> <div data-bbox="344 514 1356 1444" style="border: 1px solid black; padding: 10px;"> <p style="text-align: center;">Description</p> <p>Keeping one of the M1 to M6 keys pressed for at least 2 seconds writes a frequency to the preset memory corresponding to the pressed key. When writing to the preset memory is completed, the radio mute signal is output as acknowledgment.</p> <p>Example</p> <p>Writing</p> <p>Key operation: M1 to M6 keys are on</p> <p>Display: Frequency or clock display → The preset memory number corresponding to the pressed key is displayed. → The frequency previously received is displayed.</p> <p>When the frequency recorded in the currently selected preset memory is being received, pressing the key corresponding to this preset memory does not trigger any operation except during clock display. During clock display, pressing the key not only generates a beep but also switches to the frequency display. Pressing the key, however, does not generate the radio mute signal.</p> <p>During the seek operation, pressing the key immediately accesses the preset memory (without waiting 2 seconds).</p> </div>
M1							
M2							
M3							
M4							
M5							
M6							

Momentary key	Description														
<table border="1"> <tr><td>M1</td></tr> <tr><td>M2</td></tr> <tr><td>M3</td></tr> <tr><td>M4</td></tr> <tr><td>M5</td></tr> <tr><td>M6</td></tr> </table>	M1	M2	M3	M4	M5	M6	<table border="1"> <thead> <tr> <th colspan="2" data-bbox="423 222 1432 264">Description</th> </tr> </thead> <tbody> <tr> <td colspan="2" data-bbox="480 285 1414 348"> Pressing one of the M1 to M6 keys and releasing it within 2 seconds calls the content of the corresponding preset memory when the key is released. </td> </tr> <tr> <td colspan="2" data-bbox="480 359 1414 894"> <p>Example</p> <p>The diagram illustrates the timing sequence for calling a preset memory. It shows three horizontal axes: RDMUTE pin output, Key operation, and Display. <ul style="list-style-type: none"> RDMUTE pin output: Starts with a 15 ms pulse. It remains high for a total of 2 seconds (including the 15 ms pulse). After this 2-second period, it drops to low for 40 ms (labeled 'Beep'), then returns to high for 400 - 500 ms. Key operation: Shows 'M1 to M6 keys are on' during the 15 ms pulse and the 2-second period. 'Keys are off' after the 2-second period. Display: Shows 'Frequency or clock display' during the 15 ms pulse. During the 2-second period, it shows 'The preset memory number corresponding to the pressed key is displayed. The frequency previously received is displayed.' After the 400 - 500 ms period, it shows 'The preset memory number corresponding to the pressed key is displayed. The frequency recorded in the preset memory is displayed.' </p> </td> </tr> <tr> <td colspan="2" data-bbox="480 915 1414 1104"> <p>When the frequency recorded in the currently selected preset memory is being received, pressing the key corresponding to this preset memory does not trigger any operation except during clock display. During clock display, pressing the key not only generates a beep but also switches to the frequency display. Pressing the key, however, does not generate the radio mute signal.</p> <p>During the seek operation, pressing the key immediately accesses the preset memory.</p> </td> </tr> </tbody> </table>	Description		Pressing one of the M1 to M6 keys and releasing it within 2 seconds calls the content of the corresponding preset memory when the key is released.		<p>Example</p> <p>The diagram illustrates the timing sequence for calling a preset memory. It shows three horizontal axes: RDMUTE pin output, Key operation, and Display. <ul style="list-style-type: none"> RDMUTE pin output: Starts with a 15 ms pulse. It remains high for a total of 2 seconds (including the 15 ms pulse). After this 2-second period, it drops to low for 40 ms (labeled 'Beep'), then returns to high for 400 - 500 ms. Key operation: Shows 'M1 to M6 keys are on' during the 15 ms pulse and the 2-second period. 'Keys are off' after the 2-second period. Display: Shows 'Frequency or clock display' during the 15 ms pulse. During the 2-second period, it shows 'The preset memory number corresponding to the pressed key is displayed. The frequency previously received is displayed.' After the 400 - 500 ms period, it shows 'The preset memory number corresponding to the pressed key is displayed. The frequency recorded in the preset memory is displayed.' </p>		<p>When the frequency recorded in the currently selected preset memory is being received, pressing the key corresponding to this preset memory does not trigger any operation except during clock display. During clock display, pressing the key not only generates a beep but also switches to the frequency display. Pressing the key, however, does not generate the radio mute signal.</p> <p>During the seek operation, pressing the key immediately accesses the preset memory.</p>	
M1															
M2															
M3															
M4															
M5															
M6															
Description															
Pressing one of the M1 to M6 keys and releasing it within 2 seconds calls the content of the corresponding preset memory when the key is released.															
<p>Example</p> <p>The diagram illustrates the timing sequence for calling a preset memory. It shows three horizontal axes: RDMUTE pin output, Key operation, and Display. <ul style="list-style-type: none"> RDMUTE pin output: Starts with a 15 ms pulse. It remains high for a total of 2 seconds (including the 15 ms pulse). After this 2-second period, it drops to low for 40 ms (labeled 'Beep'), then returns to high for 400 - 500 ms. Key operation: Shows 'M1 to M6 keys are on' during the 15 ms pulse and the 2-second period. 'Keys are off' after the 2-second period. Display: Shows 'Frequency or clock display' during the 15 ms pulse. During the 2-second period, it shows 'The preset memory number corresponding to the pressed key is displayed. The frequency previously received is displayed.' After the 400 - 500 ms period, it shows 'The preset memory number corresponding to the pressed key is displayed. The frequency recorded in the preset memory is displayed.' </p>															
<p>When the frequency recorded in the currently selected preset memory is being received, pressing the key corresponding to this preset memory does not trigger any operation except during clock display. During clock display, pressing the key not only generates a beep but also switches to the frequency display. Pressing the key, however, does not generate the radio mute signal.</p> <p>During the seek operation, pressing the key immediately accesses the preset memory.</p>															

Momentary key	Description																																																																																																																																																
M1	When power is applied, the frequencies listed below are written to the M1 to M6 preset memories for convenience of set adjustment.																																																																																																																																																
M2																																																																																																																																																	
M3																																																																																																																																																	
M4																																																																																																																																																	
M5																																																																																																																																																	
M6																																																																																																																																																	
	<table border="1"> <thead> <tr> <th rowspan="2">Area</th> <th rowspan="2">Memory Band</th> <th>M1</th> <th>M2</th> <th>M3</th> <th>M4</th> <th>M5</th> <th>M6</th> </tr> </thead> <tbody> <tr> <td>Eastern Europe</td> <td>FM1(MHz)</td> <td>65.0</td> <td>67.0</td> <td>68.5</td> <td>70.5</td> <td>72.5</td> <td>74.0</td> </tr> <tr> <td></td> <td>FM2(MHz)</td> <td>87.5</td> <td>87.7</td> <td>92.3</td> <td>96.3</td> <td>105.9</td> <td>87.5</td> </tr> <tr> <td></td> <td>MW1(kHz)</td> <td>522</td> <td>603</td> <td>954</td> <td>1 386</td> <td>522</td> <td>522</td> </tr> <tr> <td></td> <td>MW2(kHz)</td> <td>522</td> <td>621</td> <td>1 098</td> <td>1 530</td> <td>522</td> <td>522</td> </tr> <tr> <td></td> <td>LW(kHz)</td> <td>144</td> <td>155</td> <td>208</td> <td>256</td> <td>144</td> <td>144</td> </tr> <tr> <td>Western Europe</td> <td>FM1(MHz)</td> <td>87.5</td> <td>87.7</td> <td>92.3</td> <td>96.3</td> <td>105.9</td> <td>87.5</td> </tr> <tr> <td></td> <td>MW1(kHz)</td> <td>522</td> <td>603</td> <td>954</td> <td>1 386</td> <td>522</td> <td>522</td> </tr> <tr> <td></td> <td>MW2(kHz)</td> <td>522</td> <td>621</td> <td>1 098</td> <td>1 530</td> <td>522</td> <td>522</td> </tr> <tr> <td></td> <td>LW(kHz)</td> <td>144</td> <td>155</td> <td>208</td> <td>256</td> <td>144</td> <td>144</td> </tr> <tr> <td>USA 1, USA 2, and USA 3</td> <td>FM1(MHz)</td> <td>87.5</td> <td>87.9</td> <td>97.1</td> <td>105.1</td> <td>87.5</td> <td>87.5</td> </tr> <tr> <td></td> <td>MW1(kHz)</td> <td>530</td> <td>620</td> <td>1 010</td> <td>1 490</td> <td>530</td> <td>530</td> </tr> <tr> <td>Australia</td> <td>FM1(MHz)</td> <td>87.5</td> <td>87.9</td> <td>97.1</td> <td>105.1</td> <td>87.5</td> <td>87.5</td> </tr> <tr> <td>Middle and Near East</td> <td>MW1(kHz)</td> <td>531</td> <td>612</td> <td>963</td> <td>1 395</td> <td>531</td> <td>531</td> </tr> <tr> <td>Japan</td> <td>FM1(MHz)</td> <td>76.0</td> <td>76.4</td> <td>85.6</td> <td>76.0</td> <td>76.0</td> <td>76.0</td> </tr> <tr> <td></td> <td>MW1(kHz)</td> <td>522</td> <td>603</td> <td>954</td> <td>1 386</td> <td>522</td> <td>522</td> </tr> <tr> <td>China</td> <td>FM1(MHz)</td> <td>87.0</td> <td>87.7</td> <td>92.3</td> <td>87.0</td> <td>87.0</td> <td>87.0</td> </tr> <tr> <td></td> <td>MW1(kHz)</td> <td>531</td> <td>540</td> <td>585</td> <td>531</td> <td>531</td> <td>531</td> </tr> </tbody> </table>	Area	Memory Band	M1	M2	M3	M4	M5	M6	Eastern Europe	FM1(MHz)	65.0	67.0	68.5	70.5	72.5	74.0		FM2(MHz)	87.5	87.7	92.3	96.3	105.9	87.5		MW1(kHz)	522	603	954	1 386	522	522		MW2(kHz)	522	621	1 098	1 530	522	522		LW(kHz)	144	155	208	256	144	144	Western Europe	FM1(MHz)	87.5	87.7	92.3	96.3	105.9	87.5		MW1(kHz)	522	603	954	1 386	522	522		MW2(kHz)	522	621	1 098	1 530	522	522		LW(kHz)	144	155	208	256	144	144	USA 1, USA 2, and USA 3	FM1(MHz)	87.5	87.9	97.1	105.1	87.5	87.5		MW1(kHz)	530	620	1 010	1 490	530	530	Australia	FM1(MHz)	87.5	87.9	97.1	105.1	87.5	87.5	Middle and Near East	MW1(kHz)	531	612	963	1 395	531	531	Japan	FM1(MHz)	76.0	76.4	85.6	76.0	76.0	76.0		MW1(kHz)	522	603	954	1 386	522	522	China	FM1(MHz)	87.0	87.7	92.3	87.0	87.0	87.0		MW1(kHz)	531	540	585	531	531	531
Area	Memory Band			M1	M2	M3	M4	M5	M6																																																																																																																																								
		Eastern Europe	FM1(MHz)	65.0	67.0	68.5	70.5	72.5	74.0																																																																																																																																								
	FM2(MHz)	87.5	87.7	92.3	96.3	105.9	87.5																																																																																																																																										
	MW1(kHz)	522	603	954	1 386	522	522																																																																																																																																										
	MW2(kHz)	522	621	1 098	1 530	522	522																																																																																																																																										
	LW(kHz)	144	155	208	256	144	144																																																																																																																																										
Western Europe	FM1(MHz)	87.5	87.7	92.3	96.3	105.9	87.5																																																																																																																																										
	MW1(kHz)	522	603	954	1 386	522	522																																																																																																																																										
	MW2(kHz)	522	621	1 098	1 530	522	522																																																																																																																																										
	LW(kHz)	144	155	208	256	144	144																																																																																																																																										
USA 1, USA 2, and USA 3	FM1(MHz)	87.5	87.9	97.1	105.1	87.5	87.5																																																																																																																																										
	MW1(kHz)	530	620	1 010	1 490	530	530																																																																																																																																										
Australia	FM1(MHz)	87.5	87.9	97.1	105.1	87.5	87.5																																																																																																																																										
Middle and Near East	MW1(kHz)	531	612	963	1 395	531	531																																																																																																																																										
Japan	FM1(MHz)	76.0	76.4	85.6	76.0	76.0	76.0																																																																																																																																										
	MW1(kHz)	522	603	954	1 386	522	522																																																																																																																																										
China	FM1(MHz)	87.0	87.7	92.3	87.0	87.0	87.0																																																																																																																																										
	MW1(kHz)	531	540	585	531	531	531																																																																																																																																										
	The lowest frequency for each area is written to the M1 to M6 preset memories for the MW2 band for the areas other than Europe 1 or Europe 2 and for the FM2 and FM3 bands.																																																																																																																																																
	○ Operation in tape mode The M5 key may also be used as the tape function (MTL) key depending on the states of the KTAPE initial setting diode. See Section 2.6.1 for details. See also the descriptions of the MTL key.																																																																																																																																																

Momentary key	Description																		
<div style="border: 1px solid black; padding: 2px; display: inline-block; margin-bottom: 2px;">MAN UP</div> <div style="border: 1px solid black; padding: 2px; display: inline-block;">MAN DWN</div>	<p>The MAN UP and MAN DWN keys are used to increment and decrement the reception frequency in radio mode, respectively. During clock display, they are also used in connection with the DISP key to adjust the clock. They are again used to increase/decrease the volume of sound during electronic volume control if VKYSEL = 1.</p> <p>(1) In radio, radio-monitor tape, and radio-monitor CD modes Either of the following operations occurs depending on the state of the AUTO500 initial setting diode.</p> <table border="1" style="width: 100%; border-collapse: collapse;"> <thead> <tr> <th style="text-align: center;">AUTO500</th> <th style="text-align: center;">Description</th> </tr> </thead> <tbody> <tr> <td style="text-align: center;">0</td> <td>Each time the MAN UP or MAN DWN key is pressed, the frequency counter is incremented (MAN UP key) or decremented (MAN DWN key) by one step (one channel space). Keeping the key pressed for at least 0.5 seconds speeds the increment/decrement to a rate of one step per 50 ms.</td> </tr> <tr> <td style="text-align: center;">1</td> <td>Each time the MAN UP or MAN DWN key is pressed, the frequency counter is incremented (MAN UP key) or decremented (MAN DWN key) by one step (one channel space). Keeping the MAN UP key pressed for at least 0.5 seconds triggers a seek operation in seek-up mode. This seek operation is the same as that triggered by the SEEK UP key.</td> </tr> </tbody> </table> <p>(1: Shorted by the diode; 0: Open)</p> <p>(2) While “TAPE” is displayed in tape mode or “CD” is displayed in CD mode The MAN UP and MAN DWN keys are ineffective.</p> <p>(3) During clock display While the DISP key is held pressed during clock display, pressing the MAN UP and MAN DWN keys enables adjusting the minute and hour displays, respectively. See the description of the DISP key for how to adjust the minute and hour displays.</p> <p>(4) When the electronic volume control function is effective and VKYSEL = 1: The MAN UP and MAN DWN keys are used to adjust (increase and decrease) the volume of sound in the electronic volume control mode selected using the VOL SEL key. Once an electronic volume control mode is selected using the VOL SEL key, the MAN UP and MAN DWN keys function in the same way as the VOL UP and VOL DWN keys. In a mode other than an electronic volume control mode, the MAN UP or MAN DWN key does not function as a volume control. Pressing the MAN UP key works for each electronic volume control mode as follows:</p> <table border="1" style="width: 100%; border-collapse: collapse;"> <thead> <tr> <th style="text-align: center;">Mode</th> <th style="text-align: center;">Function</th> </tr> </thead> <tbody> <tr> <td style="text-align: center;">Volume</td> <td>Increases the main sound volume.</td> </tr> <tr> <td style="text-align: center;">Bass</td> <td>Increases the bass.</td> </tr> <tr> <td style="text-align: center;">Treble</td> <td>Increases the treble.</td> </tr> <tr> <td style="text-align: center;">Balance</td> <td>Emphasizes the sound volume from the right-side speaker.</td> </tr> <tr> <td style="text-align: center;">Fader</td> <td>Emphasizes the sound volume from the front speaker.</td> </tr> </tbody> </table>	AUTO500	Description	0	Each time the MAN UP or MAN DWN key is pressed, the frequency counter is incremented (MAN UP key) or decremented (MAN DWN key) by one step (one channel space). Keeping the key pressed for at least 0.5 seconds speeds the increment/decrement to a rate of one step per 50 ms.	1	Each time the MAN UP or MAN DWN key is pressed, the frequency counter is incremented (MAN UP key) or decremented (MAN DWN key) by one step (one channel space). Keeping the MAN UP key pressed for at least 0.5 seconds triggers a seek operation in seek-up mode. This seek operation is the same as that triggered by the SEEK UP key.	Mode	Function	Volume	Increases the main sound volume.	Bass	Increases the bass.	Treble	Increases the treble.	Balance	Emphasizes the sound volume from the right-side speaker.	Fader	Emphasizes the sound volume from the front speaker.
AUTO500	Description																		
0	Each time the MAN UP or MAN DWN key is pressed, the frequency counter is incremented (MAN UP key) or decremented (MAN DWN key) by one step (one channel space). Keeping the key pressed for at least 0.5 seconds speeds the increment/decrement to a rate of one step per 50 ms.																		
1	Each time the MAN UP or MAN DWN key is pressed, the frequency counter is incremented (MAN UP key) or decremented (MAN DWN key) by one step (one channel space). Keeping the MAN UP key pressed for at least 0.5 seconds triggers a seek operation in seek-up mode. This seek operation is the same as that triggered by the SEEK UP key.																		
Mode	Function																		
Volume	Increases the main sound volume.																		
Bass	Increases the bass.																		
Treble	Increases the treble.																		
Balance	Emphasizes the sound volume from the right-side speaker.																		
Fader	Emphasizes the sound volume from the front speaker.																		

Momentary key	Description																		
<div style="border: 1px solid black; padding: 2px; margin-bottom: 2px; width: fit-content;">MAN UP</div> <div style="border: 1px solid black; padding: 2px; margin-bottom: 2px; width: fit-content;">MAN DWN</div>	<p>Pressing the MAN DWN key works for each electronic volume control mode as follows:</p> <table border="1" data-bbox="342 254 1143 533"> <thead> <tr> <th>Mode</th> <th>Function</th> </tr> </thead> <tbody> <tr> <td>Volume</td> <td>Decreases the main sound volume.</td> </tr> <tr> <td>Bass</td> <td>Decreases the bass.</td> </tr> <tr> <td>Treble</td> <td>Decreases the treble.</td> </tr> <tr> <td>Balance</td> <td>Emphasizes the sound volume from the left-side speaker.</td> </tr> <tr> <td>Fader</td> <td>Emphasizes the sound volume from the rear speaker.</td> </tr> </tbody> </table>	Mode	Function	Volume	Decreases the main sound volume.	Bass	Decreases the bass.	Treble	Decreases the treble.	Balance	Emphasizes the sound volume from the left-side speaker.	Fader	Emphasizes the sound volume from the rear speaker.						
Mode	Function																		
Volume	Decreases the main sound volume.																		
Bass	Decreases the bass.																		
Treble	Decreases the treble.																		
Balance	Emphasizes the sound volume from the left-side speaker.																		
Fader	Emphasizes the sound volume from the rear speaker.																		
<div style="border: 1px solid black; padding: 2px; margin-bottom: 2px; width: fit-content;">MONO/LOC</div>	<p>The MONO/LOC key controls MONO (monaural)/STEREO mode and local (local/DX) mode.</p> <p>(1) Monaural mode control</p> <p>When this key is pressed and held down for two seconds or more, MONO and STEREO modes can be switched.</p> <p>The key is effective, when the current mode is radio, radio-monitor CD, or radio-monitor tape mode and the FM or MW band is selected. (For the MW band, the key is effective if the MWS initial setting diode = 1 and the tuner has a stereo capability.)</p> <p>Each time the key is pressed, switching occurs between MONO and STEREO modes.</p> <p>The following table lists MONO/STEREO mode and the states of the “ST” display and “MONO” display.</p> <table border="1" data-bbox="342 873 938 1045"> <thead> <tr> <th>MONO/STEREO mode</th> <th>“ST” display</th> <th>“MONO” display</th> </tr> </thead> <tbody> <tr> <td>MONO</td> <td>Does not light</td> <td>Lights</td> </tr> <tr> <td>STEREO</td> <td>Lights</td> <td>Does not light</td> </tr> </tbody> </table> <p>(2) Local mode control</p> <p>The key is effective when the current mode is radio, radio-monitor CD, or radio-monitor tape mode and when AUTOLOC initial setting diode = 0.</p> <p>Each time the key is pressed, switching occurs between local and DX modes (only when the key is released within two seconds).</p> <p>The following table lists local/DX mode, the state of the “LOC” display, and LOC pin output.</p> <table border="1" data-bbox="342 1268 899 1423"> <thead> <tr> <th>Local/DX mode</th> <th>“LOC” display</th> <th>LOC pin</th> </tr> </thead> <tbody> <tr> <td>LOCAL</td> <td>Lights</td> <td>High level^{Note}</td> </tr> <tr> <td>DX</td> <td>Does not light</td> <td>Low level</td> </tr> </tbody> </table> <p>Note A high level is output only during auto-tuning. The LOC pin is always at a low level during a tuning type other than auto-tuning.</p> <p>See the description of the LOC in Chapter 1.</p>	MONO/STEREO mode	“ST” display	“MONO” display	MONO	Does not light	Lights	STEREO	Lights	Does not light	Local/DX mode	“LOC” display	LOC pin	LOCAL	Lights	High level ^{Note}	DX	Does not light	Low level
MONO/STEREO mode	“ST” display	“MONO” display																	
MONO	Does not light	Lights																	
STEREO	Lights	Does not light																	
Local/DX mode	“LOC” display	LOC pin																	
LOCAL	Lights	High level ^{Note}																	
DX	Does not light	Low level																	
<div style="border: 1px solid black; padding: 2px; margin-bottom: 2px; width: fit-content;">MTL</div>	<p>The MTL key controls MTL (METAL) mode. It is effective when the current mode is radio or radio-monitor tape mode. Each time the key is pressed, METAL mode is switched on or off.</p> <p>The following table lists METAL mode on/off, the states of the “METAL” display, and METAL pin output.</p> <table border="1" data-bbox="342 1682 899 1837"> <thead> <tr> <th>METAL mode</th> <th>“METAL” display</th> <th>METAL pin</th> </tr> </thead> <tbody> <tr> <td>ON</td> <td>Lights</td> <td>High level</td> </tr> <tr> <td>OFF</td> <td>Does not light</td> <td>Low level</td> </tr> </tbody> </table>	METAL mode	“METAL” display	METAL pin	ON	Lights	High level	OFF	Does not light	Low level									
METAL mode	“METAL” display	METAL pin																	
ON	Lights	High level																	
OFF	Does not light	Low level																	

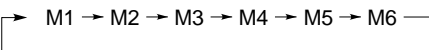
Momentary key	Description																
<p style="text-align: center;">MUTE</p>	<p>The MUTE key controls the electronic volume control mute function. Pressing the MUTE key in a mode other than mute mode selects mute (silent) mode. In mute mode, the volume value is displayed, and the display is caused to blink.</p> <p>The mute function is reset under the following conditions.</p> <ul style="list-style-type: none"> ● When an effective key other than the DISP key is pressed ● When the mode is changed ● When a station is detected during a seek or scan operation, with the MUTE pressed. ● When the MUTE key is pressed during muting 																
<p style="text-align: center;">POWER</p>	<p>The POWER key is used to control the power-on/off of the radio in momentary key mode. It is effective when the IGNITION pin is at a high level. Pressing this key inverts the output of the POWER pin. When the POWER pin output is set to low (the power is turned off), the tape recorder, CD player and radio are forced to be turned off even when they have been in the power-on state. In this case, they are turned off with or without clock display, according to whether they were in clock mode or non-clock mode. The power-on mode varies as follows according to the state of the RDSET, TPSET, and CDSET switches.</p> <table border="1" data-bbox="418 659 1218 856"> <thead> <tr> <th>Mode</th> <th>REDSET</th> <th>TPSET</th> <th>CDSET</th> </tr> </thead> <tbody> <tr> <td>Radio mode</td> <td>ON</td> <td>OFF</td> <td>OFF</td> </tr> <tr> <td>Tape mode</td> <td>ON/OFF</td> <td>ON</td> <td>OFF</td> </tr> <tr> <td>CD mode</td> <td>ON/OFF</td> <td>ON/OFF</td> <td>ON</td> </tr> </tbody> </table> <p>Caution At the initial power-on, the POWER pin outputs the high level. When the level of IGNITION pin changes from low to high, the POWER pin outputs the level which have been set before IGNITION becomes low, until the primary power supply is turned off.</p>	Mode	REDSET	TPSET	CDSET	Radio mode	ON	OFF	OFF	Tape mode	ON/OFF	ON	OFF	CD mode	ON/OFF	ON/OFF	ON
Mode	REDSET	TPSET	CDSET														
Radio mode	ON	OFF	OFF														
Tape mode	ON/OFF	ON	OFF														
CD mode	ON/OFF	ON/OFF	ON														
<p style="text-align: center;">P.SCAN</p>	<p>This key functions as a preset scan and auto-storage key. The operation triggered by the key varies depending on the state of the DISAMEMO initial setting diode.</p> <p>(1) When DISAMEMO = 0 (with the auto-storage function): The operation varies depending on the timing at which the key is operated.</p> <p>(a) If the key is released within 2 seconds: The preset scan operation begins immediately when the key is released.</p> <p>(b) If the key is pressed for at least 2 seconds: The auto-storage operation begins when 2 seconds elapse.</p> <p>(2) When DISAMEMO = 1 (without the auto-storage function): The preset scan operation begins immediately when the key is pressed.</p> <p>The preset scan and auto-storage functions are described below.</p> <ul style="list-style-type: none"> ○ Preset scan operation The contents of each preset memory are called for 5 seconds each time automatically. If a frequency other than those in the preset memories is being received, calling begins at M1. If a frequency recorded in a preset memory is being received, calling begins at the preset memory numbered one higher than that preset memory (for example, at the M4 preset memory if a frequency recorded in the M3 preset memory is being received). This operation is illustrated below. <p>Example If the FM1 band is being received:</p> <p style="text-align: center;">FM1</p> <div style="text-align: center;">  </div>																

Momentary key	Description																
<p>P.SCAN</p>	<p>The same operation occurs for the MW (MW1 and MW2) and LW bands.</p> <p>When the next preset memory is accessed after a 5-second hold period, a beep is generated. During each 5-second period, the preset memory number display blinks at 1 Hz (with a duty cycle of 50%). The "CH" display does not blink.</p> <p>To stop preset memory scanning during a 5-second hold period, press the P. SCAN key again or a preset memory key that corresponds to the preset memory being currently accessed. It is possible to write to a preset memory when another preset memory is on hold (for example, write to the M5 when the M1 is on hold). When a write operation is completed, the preset scan operation ends.</p> <p>Hold down one of the M1 to M6 keys for at least 2 seconds during the preset scan operation. The frequency currently being received is written into the preset memory corresponding to the pressed key. The preset scan operation ends immediately when any of these keys is pressed.</p> <p>During the preset scan, each key functions as follows:</p> <table border="1" data-bbox="344 646 1356 1894"> <thead> <tr> <th>Key</th> <th>Description</th> </tr> </thead> <tbody> <tr> <td>P.SCAN</td> <td>The scan operation stops, and the current frequency is received.</td> </tr> <tr> <td>SCAN UP SCAN DWN SEEK UP MAN UP MAN DWN</td> <td>The scan operation stops, the operation corresponding to the pressed key begins at the frequency being currently received.</td> </tr> <tr> <td>BAND</td> <td>In radio, radio-monitor tape, and radio-monitor CD modes, the scan operation stops, and the operation corresponding to the pressed key begins at the frequency being currently received.</td> </tr> <tr> <td>RDMONI</td> <td>Either of the following operations occurs depending on what the current mode is. (1) In radio mode The scan operation continues. The RDMONI key becomes ineffective. (2) In radio-monitor tape and radio-monitor CD modes The scan operation stops, and the operation corresponding to the pressed key begins at the frequency being currently received.</td> </tr> <tr> <td>LOUD/ILLUMINATION POWER</td> <td>The scan operation continues. The operation corresponding to the pressed key begins.</td> </tr> <tr> <td>MONO/LOC</td> <td>Either of the following operations occurs depending on the state of the AUTOLOC initial setting diode. (1) When AUTOLOC = 0: The scan operation continues. The operation corresponding to the MONO/LOC key begins. (2) When AUTOLOC = 1: The scan operation continues. The MONO/LOC key becomes ineffective.</td> </tr> <tr> <td>M1 M2 M3 M4 M5 M6</td> <td>In radio, radio-monitor tape, and radio-monitor CD modes, the scan operation stops. The other operations vary depending on the timing at which the key is released. <ul style="list-style-type: none"> ● If the key is released within 2 seconds: The preset memory corresponding to the pressed key is accessed. ● If the key is kept pressed for at least 2 seconds: A frequency being currently received is written to the preset memory corresponding to the pressed key. </td> </tr> </tbody> </table>	Key	Description	P.SCAN	The scan operation stops, and the current frequency is received.	SCAN UP SCAN DWN SEEK UP MAN UP MAN DWN	The scan operation stops, the operation corresponding to the pressed key begins at the frequency being currently received.	BAND	In radio, radio-monitor tape, and radio-monitor CD modes, the scan operation stops, and the operation corresponding to the pressed key begins at the frequency being currently received.	RDMONI	Either of the following operations occurs depending on what the current mode is. (1) In radio mode The scan operation continues. The RDMONI key becomes ineffective. (2) In radio-monitor tape and radio-monitor CD modes The scan operation stops, and the operation corresponding to the pressed key begins at the frequency being currently received.	LOUD/ILLUMINATION POWER	The scan operation continues. The operation corresponding to the pressed key begins.	MONO/LOC	Either of the following operations occurs depending on the state of the AUTOLOC initial setting diode. (1) When AUTOLOC = 0: The scan operation continues. The operation corresponding to the MONO/LOC key begins. (2) When AUTOLOC = 1: The scan operation continues. The MONO/LOC key becomes ineffective.	M1 M2 M3 M4 M5 M6	In radio, radio-monitor tape, and radio-monitor CD modes, the scan operation stops. The other operations vary depending on the timing at which the key is released. <ul style="list-style-type: none"> ● If the key is released within 2 seconds: The preset memory corresponding to the pressed key is accessed. ● If the key is kept pressed for at least 2 seconds: A frequency being currently received is written to the preset memory corresponding to the pressed key.
Key	Description																
P.SCAN	The scan operation stops, and the current frequency is received.																
SCAN UP SCAN DWN SEEK UP MAN UP MAN DWN	The scan operation stops, the operation corresponding to the pressed key begins at the frequency being currently received.																
BAND	In radio, radio-monitor tape, and radio-monitor CD modes, the scan operation stops, and the operation corresponding to the pressed key begins at the frequency being currently received.																
RDMONI	Either of the following operations occurs depending on what the current mode is. (1) In radio mode The scan operation continues. The RDMONI key becomes ineffective. (2) In radio-monitor tape and radio-monitor CD modes The scan operation stops, and the operation corresponding to the pressed key begins at the frequency being currently received.																
LOUD/ILLUMINATION POWER	The scan operation continues. The operation corresponding to the pressed key begins.																
MONO/LOC	Either of the following operations occurs depending on the state of the AUTOLOC initial setting diode. (1) When AUTOLOC = 0: The scan operation continues. The operation corresponding to the MONO/LOC key begins. (2) When AUTOLOC = 1: The scan operation continues. The MONO/LOC key becomes ineffective.																
M1 M2 M3 M4 M5 M6	In radio, radio-monitor tape, and radio-monitor CD modes, the scan operation stops. The other operations vary depending on the timing at which the key is released. <ul style="list-style-type: none"> ● If the key is released within 2 seconds: The preset memory corresponding to the pressed key is accessed. ● If the key is kept pressed for at least 2 seconds: A frequency being currently received is written to the preset memory corresponding to the pressed key. 																

Momentary key	Description
<p style="border: 1px solid black; display: inline-block; padding: 2px;">P.SCAN</p>	<ul style="list-style-type: none"> ○ Auto-storage function Broadcasting stations are searched for automatically. The frequency of a detected station is written to a preset memory. A method used to detect a station is determined according to the states of the ENAMIF and ENFMIF initial setting diodes. A broadcasting station search begins at the frequency being currently received and is performed through the frequencies in the ascending order. When a station is detected, its frequency is written to a preset memory. For the voltage with SD, see the description of the SD in Chapter 1. The auto-storage operation varies depending on the state of the AUTOLOC initial setting diode as follows: (1) When AUTOLOC = 0 (with no auto local function): The auto-storage function varies depending on which mode has been selected, local or DX, when the function begins. <ul style="list-style-type: none"> (a) If DX mode has been selected when the auto-storage function starts: A search begins at the frequency being currently received and continues in the ascending order of the frequency. When all frequencies are searched through, the search operation ends. If the P. SCAN key is pressed during the search operation, the auto-storage operation ends, and the frequency selected when the auto-storage operation began is received. When all frequencies are searched through, if at least one station is detected, the contents of the preset memories are updated, and the preset scan begins at the M1 preset memory. How the contents of the preset memories are updated varies depending on the number of stations detected. <ul style="list-style-type: none"> ○ If six or more stations are detected: If six or more stations are detected, six stations with a higher SD input are selected and written to the preset memories. A lower frequency is written to a lower-numbered preset memory. ○ If less than six stations are detected: If less than six stations are detected, lower frequencies are written to lower-numbered preset memories. The contents of a preset memory will not be changed if there is no frequency corresponding to it. (b) If local mode has been selected when the auto-storage function starts: A search begins in local mode at the frequency being currently received and continues in the ascending order of the frequency. When all frequencies are searched through, if six or more stations are not detected, the search switches to DX mode and continues in it. If six or more stations are detected in local mode, or all frequencies are searched through in DX mode, the auto-storage operation ends. Pressing the P. SCAN key during the search operation stops the auto-storage operation, and causes the frequency selected when the auto-storage memory began to be received. If six or more stations are detected in local mode, or all frequencies are searched through in DX mode, the auto-storage operation ends. If at least one station is detected, the contents of the preset memories are updated, and the preset scan begins with the M1 preset memory. How the contents of the preset memories are updated varies depending on the number of stations detected, as follows: <ul style="list-style-type: none"> ○ If six or more stations are detected in local mode: If six or more stations are detected, six stations with a higher SD input are selected and written to the preset memories. A lower frequency is written to a lower-numbered preset memory ○ If less than six stations are detected in local mode and some are detected in DX mode, resulting in a total of six or more stations being detected: Stations detected in DX mode with higher SD input levels are selected and added to the number of stations detected in local mode so that the total becomes six. In this case, the stations detected in local mode are excluded from those detected in DX mode. The frequencies of the six stations are written to the preset memories, with a lower frequency written to a lower-numbered preset memory.

Momentary key	Description
<p style="border: 1px solid black; padding: 2px; display: inline-block;">P.SCAN</p>	<ul style="list-style-type: none"> ○ If less than six stations are detected in local mode and some are detected in DX mode, resulting in a total of less than six stations being detected: If the same station is detected in DX and local modes, the station detected in DX mode is deleted so that the same frequency will not be written to two preset memories. The frequencies of the less than six stations detected are written to the preset memories, with a lower frequency written to a lower-numbered preset memory. The contents of a preset memory will not be changed if there is no frequency corresponding to it. <p>(2) When AUTOLOC = 1 (with the local function):</p> <p>A search begins in local mode at the frequency being currently received and continues in the ascending order of the frequency. When all frequencies are searched through, if six or more stations are not detected, the search switches to DX mode and continues in it. If six or more stations are detected in local mode, or all frequencies are searched through in DX mode, the auto-storage operations ends. Pressing the P. SCAN key in local mode switches to DX mode, and restarts the search operation at the frequency selected when the previous search began. Any stations detected in local mode are made ineffective. (Stations detected in local mode are excluded during preset memory updating.) Pressing the P. SCAN key in DX mode ends the auto-storage operation, and causes the frequency selected when the auto-storage operation began to be received.</p> <p>If six or more stations are detected in local mode, or all frequencies are searched through in DX mode, the auto-storage operation ends. If at least one station is detected, the contents of the preset memories are updated, and the preset scan begins with the M1 preset memory.</p> <p>How the contents of the preset memories are updated varies depending on the number of stations detected, as follows:</p> <ul style="list-style-type: none"> ○ If six or more stations are detected in local mode: If six or more stations are detected in local mode, six stations with a higher SD input are selected and written to the preset memories, with a lower frequency written to a lower-numbered preset memory. ○ If less than six stations are detected in local mode, and some are detected in DX mode, resulting in a total of six or more stations being detected: Stations detected in DX mode with higher SD input levels are selected and added to the number of stations detected in local mode so that the total becomes six. In this case, the stations detected in local mode are excluded from those detected in DX mode. The frequencies of the six stations are written to the preset memories, with a lower frequency written to a lower-numbered preset memory. ○ If less than six stations are detected in local mode and some are detected in DX mode, resulting in a total of less than six stations being detected: If the same station is detected in DX and local modes, the station detected in DX mode is deleted so that the same frequency will not be written to two preset memories. The frequencies of the less than six stations detected are written to the preset memories, with a lower frequency written to a lower-numbered preset memory. The contents of a preset memory will not be changed if there is no frequency corresponding to it.

Momentary key	Description																
<div style="border: 1px solid black; padding: 2px; width: fit-content; margin-bottom: 5px;">P.SCAN</div>	<p>During the auto-storage operation, each key function as follows:</p> <table border="1" style="width: 100%; border-collapse: collapse;"> <thead> <tr> <th style="width: 20%;">Key</th> <th>Description</th> </tr> </thead> <tbody> <tr> <td style="border: 1px solid black; padding: 2px; text-align: center;">P.SCAN</td> <td>The auto-storage operation stops, the frequency selected when the auto-storage operation began is received. If the auto local function is being used, local mode is selected.</td> </tr> <tr> <td style="border: 1px solid black; padding: 2px; text-align: center;">BAND</td> <td>In radio, radio-monitor tape, and radio-monitor CD modes, the auto-storage operation stops, the operation corresponding to the BAND key begins at the frequency selected when the auto-storage operation began.</td> </tr> <tr> <td style="border: 1px solid black; padding: 2px; text-align: center;"> <div style="border: 1px solid black; padding: 2px; margin-bottom: 2px;">SCAN UP</div> <div style="border: 1px solid black; padding: 2px; margin-bottom: 2px;">SCAN DWN</div> <div style="border: 1px solid black; padding: 2px; margin-bottom: 2px;">SEEK UP</div> <div style="border: 1px solid black; padding: 2px; margin-bottom: 2px;">MAN UP</div> <div style="border: 1px solid black; padding: 2px; margin-bottom: 2px;">MAN DWN</div> </td> <td>The auto-storage operation stops, the operation corresponding to the pressed key begins at the frequency selected when the auto-storage operation began.</td> </tr> <tr> <td style="border: 1px solid black; padding: 2px; text-align: center;">RDMONI</td> <td> <p>Either of the following operations occurs depending on what the current mode is.</p> <p>(1) In radio-monitor tape and radio-monitor CD modes The auto-storage operation stops, the operation corresponding to the RDMONI key begins at the frequency selected when the auto-storage operation began.</p> <p>(2) In radio mode The auto-storage operation continues. The RDMONI key becomes ineffective.</p> </td> </tr> <tr> <td style="border: 1px solid black; padding: 2px; text-align: center;"> <div style="border: 1px solid black; padding: 2px; margin-bottom: 2px;">LOUD/ ILLUMI- MATION</div> <div style="border: 1px solid black; padding: 2px; margin-bottom: 2px;">POWER</div> </td> <td>The auto-storage operation continues. The operation corresponding to the pressed key begins.</td> </tr> <tr> <td style="border: 1px solid black; padding: 2px; text-align: center;">MONO/LOC</td> <td> <p>Either of the following operations occurs depending on the state of the AUTOLOC initial setting diode.</p> <p>(1) When AUTOLOC = 0: Switching occurs between local and DX modes. All stations detected so far are canceled.</p> <p>(2) When AUTOLOC = 1: The auto-storage operation continues. The MONO/LOC key becomes ineffective.</p> </td> </tr> <tr> <td style="border: 1px solid black; padding: 2px; text-align: center;"> <div style="border: 1px solid black; padding: 2px; margin-bottom: 2px;">M1</div> <div style="border: 1px solid black; padding: 2px; margin-bottom: 2px;">to</div> <div style="border: 1px solid black; padding: 2px; margin-bottom: 2px;">M6</div> </td> <td>The auto-storage operation stops. The set tunes itself to the frequency recorded in the preset memory corresponding to the pressed key.</td> </tr> </tbody> </table>	Key	Description	P.SCAN	The auto-storage operation stops, the frequency selected when the auto-storage operation began is received. If the auto local function is being used, local mode is selected.	BAND	In radio, radio-monitor tape, and radio-monitor CD modes, the auto-storage operation stops, the operation corresponding to the BAND key begins at the frequency selected when the auto-storage operation began.	<div style="border: 1px solid black; padding: 2px; margin-bottom: 2px;">SCAN UP</div> <div style="border: 1px solid black; padding: 2px; margin-bottom: 2px;">SCAN DWN</div> <div style="border: 1px solid black; padding: 2px; margin-bottom: 2px;">SEEK UP</div> <div style="border: 1px solid black; padding: 2px; margin-bottom: 2px;">MAN UP</div> <div style="border: 1px solid black; padding: 2px; margin-bottom: 2px;">MAN DWN</div>	The auto-storage operation stops, the operation corresponding to the pressed key begins at the frequency selected when the auto-storage operation began.	RDMONI	<p>Either of the following operations occurs depending on what the current mode is.</p> <p>(1) In radio-monitor tape and radio-monitor CD modes The auto-storage operation stops, the operation corresponding to the RDMONI key begins at the frequency selected when the auto-storage operation began.</p> <p>(2) In radio mode The auto-storage operation continues. The RDMONI key becomes ineffective.</p>	<div style="border: 1px solid black; padding: 2px; margin-bottom: 2px;">LOUD/ ILLUMI- MATION</div> <div style="border: 1px solid black; padding: 2px; margin-bottom: 2px;">POWER</div>	The auto-storage operation continues. The operation corresponding to the pressed key begins.	MONO/LOC	<p>Either of the following operations occurs depending on the state of the AUTOLOC initial setting diode.</p> <p>(1) When AUTOLOC = 0: Switching occurs between local and DX modes. All stations detected so far are canceled.</p> <p>(2) When AUTOLOC = 1: The auto-storage operation continues. The MONO/LOC key becomes ineffective.</p>	<div style="border: 1px solid black; padding: 2px; margin-bottom: 2px;">M1</div> <div style="border: 1px solid black; padding: 2px; margin-bottom: 2px;">to</div> <div style="border: 1px solid black; padding: 2px; margin-bottom: 2px;">M6</div>	The auto-storage operation stops. The set tunes itself to the frequency recorded in the preset memory corresponding to the pressed key.
Key	Description																
P.SCAN	The auto-storage operation stops, the frequency selected when the auto-storage operation began is received. If the auto local function is being used, local mode is selected.																
BAND	In radio, radio-monitor tape, and radio-monitor CD modes, the auto-storage operation stops, the operation corresponding to the BAND key begins at the frequency selected when the auto-storage operation began.																
<div style="border: 1px solid black; padding: 2px; margin-bottom: 2px;">SCAN UP</div> <div style="border: 1px solid black; padding: 2px; margin-bottom: 2px;">SCAN DWN</div> <div style="border: 1px solid black; padding: 2px; margin-bottom: 2px;">SEEK UP</div> <div style="border: 1px solid black; padding: 2px; margin-bottom: 2px;">MAN UP</div> <div style="border: 1px solid black; padding: 2px; margin-bottom: 2px;">MAN DWN</div>	The auto-storage operation stops, the operation corresponding to the pressed key begins at the frequency selected when the auto-storage operation began.																
RDMONI	<p>Either of the following operations occurs depending on what the current mode is.</p> <p>(1) In radio-monitor tape and radio-monitor CD modes The auto-storage operation stops, the operation corresponding to the RDMONI key begins at the frequency selected when the auto-storage operation began.</p> <p>(2) In radio mode The auto-storage operation continues. The RDMONI key becomes ineffective.</p>																
<div style="border: 1px solid black; padding: 2px; margin-bottom: 2px;">LOUD/ ILLUMI- MATION</div> <div style="border: 1px solid black; padding: 2px; margin-bottom: 2px;">POWER</div>	The auto-storage operation continues. The operation corresponding to the pressed key begins.																
MONO/LOC	<p>Either of the following operations occurs depending on the state of the AUTOLOC initial setting diode.</p> <p>(1) When AUTOLOC = 0: Switching occurs between local and DX modes. All stations detected so far are canceled.</p> <p>(2) When AUTOLOC = 1: The auto-storage operation continues. The MONO/LOC key becomes ineffective.</p>																
<div style="border: 1px solid black; padding: 2px; margin-bottom: 2px;">M1</div> <div style="border: 1px solid black; padding: 2px; margin-bottom: 2px;">to</div> <div style="border: 1px solid black; padding: 2px; margin-bottom: 2px;">M6</div>	The auto-storage operation stops. The set tunes itself to the frequency recorded in the preset memory corresponding to the pressed key.																

Momentary key	Description										
<p>RDMONI</p>	<p>The RDMONI key controls radio monitoring. It is effective in tape, CD, radio-monitor tape, or radio-monitor CD mode. Each time the key is pressed, radio monitor mode is set or reset. In radio monitor mode, the "RDMONI" display on the LCD panel lights.</p> <p>In radio monitor mode, tuning is enabled for all bands, the radio mute function ($\overline{\text{RDMUTE}}$ pin) is switched off, and the audio mute function ($\overline{\text{AMUTE}}$ pin) is switched on.</p> <p>Radio monitor mode is reset by:</p> <ul style="list-style-type: none"> ● Change in the TPSET switch state ● Change in the CDSET switch state ● Change at the CE pin from high level to low level^{Note} <p>Note When using alarm mode, always pull up the CE pin.</p>										
<p>SCAN UP SCAN DWN</p>	<p>The SCAN UP and SCAN DWN keys are used for auto-tuning (scan operation). Pressing the SCAN UP key (SCAN DWN key) increases (decreases) the frequency by one channel space and checks whether there is a broadcasting station at each reception frequency (frequency counter and SD signal). If a broadcasting station is detected, the corresponding frequency is held for five seconds. If no key is pressed within this hold time of five seconds, the seek operation restarts. If another broadcasting station is detected, the corresponding frequency is held in the frequency counter for five seconds. This operation is repeated (scan operation) sequentially.</p> <p>The frequency display blinks at 1 Hz (with a duty cycle of 50%) during the five-second hold time. A beep occurs at the end of the hold time.</p> <p>The seek operation here is the same as one performed with the SEEK UP key.</p> <p>The following table lists the operation corresponding to each key pressed during the seek operation (except the hold time).</p> <table border="1" data-bbox="344 968 1354 1885"> <thead> <tr> <th data-bbox="344 968 513 1020">Key</th> <th data-bbox="513 968 1354 1020">Description</th> </tr> </thead> <tbody> <tr> <td data-bbox="344 1020 513 1325"> <p>SCAN UP SCAN DWN</p> </td> <td data-bbox="513 1020 1354 1325"> <ul style="list-style-type: none"> ● If the SCAN UP key is pressed in scan-up mode, or the SCAN DWN key is pressed in scan-down mode: The scan operation stops, and the frequency that was selected when the scan operation began is reselected. If the auto local function is being used, local mode is switched. ● If the SCAN DWN key is pressed in scan-up mode, or the SCAN UP key is pressed in scan-down mode: The operation corresponding to the pressed key begins at the frequency that is selected when the key is pressed. </td> </tr> <tr> <td data-bbox="344 1325 513 1465"> <p>SEEK UP MAN UP MAN DWN P.SCAN</p> </td> <td data-bbox="513 1325 1354 1465"> <p>The scan operation stops, and the operation corresponding to the pressed key begins at the frequency that is selected when the key is pressed.</p> </td> </tr> <tr> <td data-bbox="344 1465 513 1606"> <p>BAND</p> </td> <td data-bbox="513 1465 1354 1606"> <p>In radio, radio-monitor tape, and radio-monitor CD modes, the scan operation stops. The frequency that was selected when the scan operation began (or the frequency on hold if a broadcasting station has been detected during the scan operation) is reselected, and the operation corresponding to the pressed key begins.</p> </td> </tr> <tr> <td data-bbox="344 1606 513 1885"> <p>RDMONI</p> </td> <td data-bbox="513 1606 1354 1885"> <p>Either of the following operations occurs depending on what the current mode is.</p> <p>(1) In radio-monitor tape and radio-monitor CD modes The scan operation stops. The frequency that was selected when the scan operation began (or the frequency on hold if a broadcasting station has been detected during the scan operation) is reselected, and the operation corresponding to the pressed key begins.</p> <p>(2) In radio mode The seek operation continues, and the key becomes an ineffective key.</p> </td> </tr> </tbody> </table>	Key	Description	<p>SCAN UP SCAN DWN</p>	<ul style="list-style-type: none"> ● If the SCAN UP key is pressed in scan-up mode, or the SCAN DWN key is pressed in scan-down mode: The scan operation stops, and the frequency that was selected when the scan operation began is reselected. If the auto local function is being used, local mode is switched. ● If the SCAN DWN key is pressed in scan-up mode, or the SCAN UP key is pressed in scan-down mode: The operation corresponding to the pressed key begins at the frequency that is selected when the key is pressed. 	<p>SEEK UP MAN UP MAN DWN P.SCAN</p>	<p>The scan operation stops, and the operation corresponding to the pressed key begins at the frequency that is selected when the key is pressed.</p>	<p>BAND</p>	<p>In radio, radio-monitor tape, and radio-monitor CD modes, the scan operation stops. The frequency that was selected when the scan operation began (or the frequency on hold if a broadcasting station has been detected during the scan operation) is reselected, and the operation corresponding to the pressed key begins.</p>	<p>RDMONI</p>	<p>Either of the following operations occurs depending on what the current mode is.</p> <p>(1) In radio-monitor tape and radio-monitor CD modes The scan operation stops. The frequency that was selected when the scan operation began (or the frequency on hold if a broadcasting station has been detected during the scan operation) is reselected, and the operation corresponding to the pressed key begins.</p> <p>(2) In radio mode The seek operation continues, and the key becomes an ineffective key.</p>
Key	Description										
<p>SCAN UP SCAN DWN</p>	<ul style="list-style-type: none"> ● If the SCAN UP key is pressed in scan-up mode, or the SCAN DWN key is pressed in scan-down mode: The scan operation stops, and the frequency that was selected when the scan operation began is reselected. If the auto local function is being used, local mode is switched. ● If the SCAN DWN key is pressed in scan-up mode, or the SCAN UP key is pressed in scan-down mode: The operation corresponding to the pressed key begins at the frequency that is selected when the key is pressed. 										
<p>SEEK UP MAN UP MAN DWN P.SCAN</p>	<p>The scan operation stops, and the operation corresponding to the pressed key begins at the frequency that is selected when the key is pressed.</p>										
<p>BAND</p>	<p>In radio, radio-monitor tape, and radio-monitor CD modes, the scan operation stops. The frequency that was selected when the scan operation began (or the frequency on hold if a broadcasting station has been detected during the scan operation) is reselected, and the operation corresponding to the pressed key begins.</p>										
<p>RDMONI</p>	<p>Either of the following operations occurs depending on what the current mode is.</p> <p>(1) In radio-monitor tape and radio-monitor CD modes The scan operation stops. The frequency that was selected when the scan operation began (or the frequency on hold if a broadcasting station has been detected during the scan operation) is reselected, and the operation corresponding to the pressed key begins.</p> <p>(2) In radio mode The seek operation continues, and the key becomes an ineffective key.</p>										

Momentary key	Description	
<div style="border: 1px solid black; padding: 2px; margin-bottom: 2px; width: fit-content;">SCAN UP</div> <div style="border: 1px solid black; padding: 2px; margin-bottom: 2px; width: fit-content;">SCAN DWN</div>	<div style="border: 1px solid black; padding: 2px; width: fit-content;">Key</div>	<div style="border: 1px solid black; padding: 2px; width: fit-content;">Description</div>
	<div style="border: 1px solid black; padding: 2px; width: fit-content;">LOUD/ ILLUMI- NATION</div> <div style="border: 1px solid black; padding: 2px; width: fit-content;">POWER</div>	<p>The scan operation continues, and the operation corresponding to the pressed key begins.</p>
	<div style="border: 1px solid black; padding: 2px; width: fit-content;">MONO/LOC</div>	<p>Either of the following operations occurs depending on the state of the AUTOLOC initial setting diode.</p> <p>(1) When AUTOLOC = 0: The scan operation continues, and the operation corresponding to the key begins.</p> <p>(2) When AUTOLOC = 1: The scan operation continues, and the key becomes invalid.</p>
	<div style="border: 1px solid black; padding: 2px; width: fit-content;">M1</div> <div style="border: 1px solid black; padding: 2px; width: fit-content;">to</div> <div style="border: 1px solid black; padding: 2px; width: fit-content;">M6</div>	<p>The scan operation stops. The set tunes itself to the frequency recorded in the preset memory corresponding to the pressed key.</p>

Momentary key	Description														
<div style="border: 1px solid black; padding: 2px; width: fit-content;">SCAN UP</div> <div style="border: 1px solid black; padding: 2px; width: fit-content;">SCAN DWN</div>	<p>Each key functions during the five-second hold time as follows:</p> <table border="1" style="width: 100%; border-collapse: collapse;"> <thead> <tr> <th style="width: 20%;">Key</th> <th>Description</th> </tr> </thead> <tbody> <tr> <td data-bbox="350 302 509 373"> <div style="border: 1px solid black; padding: 2px; width: fit-content;">SCAN UP</div> <div style="border: 1px solid black; padding: 2px; width: fit-content;">SCAN DWN</div> </td> <td data-bbox="509 302 1357 541"> <ul style="list-style-type: none"> ● If the SCAN UP key is pressed in scan-up mode, or the SCAN DWN key is pressed in scan-down mode: The scan operation stops, and the frequency counter is set to the frequency on hold. ● If the SCAN DWN key is pressed in scan-up mode, or the SCAN UP key is pressed in scan-down mode: The operation corresponding to the pressed key begins. </td> </tr> <tr> <td data-bbox="350 541 509 680"> <div style="border: 1px solid black; padding: 2px; width: fit-content;">SEEK UP</div> <div style="border: 1px solid black; padding: 2px; width: fit-content;">MAN UP</div> <div style="border: 1px solid black; padding: 2px; width: fit-content;">MAN DWN</div> <div style="border: 1px solid black; padding: 2px; width: fit-content;">P.SCAN</div> </td> <td data-bbox="509 541 1357 680"> <p>The scan operation stops, and the operation corresponding to the pressed key begins at the frequency on hold.</p> </td> </tr> <tr> <td data-bbox="350 680 509 793"> <div style="border: 1px solid black; padding: 2px; width: fit-content;">BAND</div> </td> <td data-bbox="509 680 1357 793"> <p>In radio, radio-monitor tape, and radio-monitor CD modes, the scan operation stops. The operation corresponding to the pressed key begins at the frequency on hold.</p> </td> </tr> <tr> <td data-bbox="350 793 509 1003"> <div style="border: 1px solid black; padding: 2px; width: fit-content;">RDMONI</div> </td> <td data-bbox="509 793 1357 1003"> <p>Either of the following operations occurs depending on what the current mode is.</p> <p>(1) In radio-monitor tape and radio-monitor CD modes The scan operation stops. The operation corresponding to the pressed key begins at the frequency on hold.</p> <p>(2) In radio mode The seek operation continues, and the key becomes an ineffective key.</p> </td> </tr> <tr> <td data-bbox="350 1003 509 1142"> <div style="border: 1px solid black; padding: 2px; width: fit-content;">LOUD/ ILLUMI- NATION</div> <div style="border: 1px solid black; padding: 2px; width: fit-content;">POWER</div> </td> <td data-bbox="509 1003 1357 1142"> <p>The scan operation continues. The operation corresponding to the pressed key begins.</p> </td> </tr> <tr> <td data-bbox="350 1142 509 1415"> <div style="border: 1px solid black; padding: 2px; width: fit-content;">MONO/LOC</div> </td> <td data-bbox="509 1142 1357 1415"> <p>Either of the following operations occurs depending on the state of the AUTOLOC initial setting diode.</p> <p>(1) When AUTOLOC = 0: The scan operation continues, and the operation corresponding to the pressed key begins.</p> <p>(2) When AUTOLOC = 1: The scan operation continues, and the pressed key becomes an ineffective key.</p> </td> </tr> </tbody> </table>	Key	Description	<div style="border: 1px solid black; padding: 2px; width: fit-content;">SCAN UP</div> <div style="border: 1px solid black; padding: 2px; width: fit-content;">SCAN DWN</div>	<ul style="list-style-type: none"> ● If the SCAN UP key is pressed in scan-up mode, or the SCAN DWN key is pressed in scan-down mode: The scan operation stops, and the frequency counter is set to the frequency on hold. ● If the SCAN DWN key is pressed in scan-up mode, or the SCAN UP key is pressed in scan-down mode: The operation corresponding to the pressed key begins. 	<div style="border: 1px solid black; padding: 2px; width: fit-content;">SEEK UP</div> <div style="border: 1px solid black; padding: 2px; width: fit-content;">MAN UP</div> <div style="border: 1px solid black; padding: 2px; width: fit-content;">MAN DWN</div> <div style="border: 1px solid black; padding: 2px; width: fit-content;">P.SCAN</div>	<p>The scan operation stops, and the operation corresponding to the pressed key begins at the frequency on hold.</p>	<div style="border: 1px solid black; padding: 2px; width: fit-content;">BAND</div>	<p>In radio, radio-monitor tape, and radio-monitor CD modes, the scan operation stops. The operation corresponding to the pressed key begins at the frequency on hold.</p>	<div style="border: 1px solid black; padding: 2px; width: fit-content;">RDMONI</div>	<p>Either of the following operations occurs depending on what the current mode is.</p> <p>(1) In radio-monitor tape and radio-monitor CD modes The scan operation stops. The operation corresponding to the pressed key begins at the frequency on hold.</p> <p>(2) In radio mode The seek operation continues, and the key becomes an ineffective key.</p>	<div style="border: 1px solid black; padding: 2px; width: fit-content;">LOUD/ ILLUMI- NATION</div> <div style="border: 1px solid black; padding: 2px; width: fit-content;">POWER</div>	<p>The scan operation continues. The operation corresponding to the pressed key begins.</p>	<div style="border: 1px solid black; padding: 2px; width: fit-content;">MONO/LOC</div>	<p>Either of the following operations occurs depending on the state of the AUTOLOC initial setting diode.</p> <p>(1) When AUTOLOC = 0: The scan operation continues, and the operation corresponding to the pressed key begins.</p> <p>(2) When AUTOLOC = 1: The scan operation continues, and the pressed key becomes an ineffective key.</p>
Key	Description														
<div style="border: 1px solid black; padding: 2px; width: fit-content;">SCAN UP</div> <div style="border: 1px solid black; padding: 2px; width: fit-content;">SCAN DWN</div>	<ul style="list-style-type: none"> ● If the SCAN UP key is pressed in scan-up mode, or the SCAN DWN key is pressed in scan-down mode: The scan operation stops, and the frequency counter is set to the frequency on hold. ● If the SCAN DWN key is pressed in scan-up mode, or the SCAN UP key is pressed in scan-down mode: The operation corresponding to the pressed key begins. 														
<div style="border: 1px solid black; padding: 2px; width: fit-content;">SEEK UP</div> <div style="border: 1px solid black; padding: 2px; width: fit-content;">MAN UP</div> <div style="border: 1px solid black; padding: 2px; width: fit-content;">MAN DWN</div> <div style="border: 1px solid black; padding: 2px; width: fit-content;">P.SCAN</div>	<p>The scan operation stops, and the operation corresponding to the pressed key begins at the frequency on hold.</p>														
<div style="border: 1px solid black; padding: 2px; width: fit-content;">BAND</div>	<p>In radio, radio-monitor tape, and radio-monitor CD modes, the scan operation stops. The operation corresponding to the pressed key begins at the frequency on hold.</p>														
<div style="border: 1px solid black; padding: 2px; width: fit-content;">RDMONI</div>	<p>Either of the following operations occurs depending on what the current mode is.</p> <p>(1) In radio-monitor tape and radio-monitor CD modes The scan operation stops. The operation corresponding to the pressed key begins at the frequency on hold.</p> <p>(2) In radio mode The seek operation continues, and the key becomes an ineffective key.</p>														
<div style="border: 1px solid black; padding: 2px; width: fit-content;">LOUD/ ILLUMI- NATION</div> <div style="border: 1px solid black; padding: 2px; width: fit-content;">POWER</div>	<p>The scan operation continues. The operation corresponding to the pressed key begins.</p>														
<div style="border: 1px solid black; padding: 2px; width: fit-content;">MONO/LOC</div>	<p>Either of the following operations occurs depending on the state of the AUTOLOC initial setting diode.</p> <p>(1) When AUTOLOC = 0: The scan operation continues, and the operation corresponding to the pressed key begins.</p> <p>(2) When AUTOLOC = 1: The scan operation continues, and the pressed key becomes an ineffective key.</p>														

Momentary key	Description
SCAN UP	
SCAN DWN	
Key	Description
M1 to M6	<p>The scan operation stops.</p> <p>Either of the following operations occurs depending on the timing at which the key is released.</p> <ul style="list-style-type: none"> ○ If the key is released within 2 seconds: A preset memory corresponding to the pressed key is accessed. ○ If the key is held pressed for at least 2 seconds: The frequency being currently received is written to the preset memory corresponding to the pressed key.
	<p>Example 1. If the key is released within 2 seconds: The tuner is set to the frequency in the preset memory corresponding to the pressed key when the key is released. The scan operation is canceled.</p>
	<p>The diagram shows the RDMUTE pin (active low) going high. A 'Seek' operation is indicated. 'Station detected' occurs. The 'M1' key is pressed and held for 'Within 5 seconds'. It is then released 'Within 2 seconds' after the hold period. 'M1 accessed' is noted. The display sequence is: 90.0 (Example of display) → 90.1 (Blinking) → 90.1 CH (Blinking) → 90.2 (Content of M1).</p>
	<p>2. If the key is pressed for at least 2 seconds: When the key is pressed for 2 seconds, the frequency on hold is written to the preset memory corresponding to the pressed key. The hold state is released 2 seconds after the writing to the preset memory, and a search (seek operation) for another station begins.</p>
	<p>The diagram shows the RDMUTE pin (active low) going high. A 'Seek' operation is indicated. 'Station detected' occurs. The 'M1' key is pressed and held for 'Within 5 seconds'. It is held for '2 seconds' after the hold period. The display sequence is: 90.0 (Example of display) → 90.1 (Blinking) → 90.1 CH (Blinking) → 90.1 CH (Blinking) → 90.2.</p>

Momentary key	Description												
<div style="border: 1px solid black; padding: 2px; width: fit-content; margin-bottom: 5px;">SEEK UP</div>	<p>The SEEK UP key is used for auto-tuning (seek operation). Pressing the SEEK UP key increases the frequency by one channel space and checks whether there is a broadcasting station at each reception frequency (by a method determined depending on the states of the ENAMIF and ENFMIF initial setting diodes). If a broadcasting station is detected, the seek operation ends. The seek operation performed varies with the state of the AUTOLOC initial setting diode as follows:</p> <p>(1) When AUTOLOC = 0 (with no auto local function): A search operation begins at the frequency currently being received. The search operation continues in local or DX mode whichever has been selected when the search operation starts, until a station is detected.</p> <p>(2) When AUTOLOC = 1 (with an auto local function): A search operation begins at the frequency being currently received in local mode. When all frequencies are searched through in local mode, a search operation is switched to DX mode and continues until a station is detected. If the SEEK UP key is pressed in local mode, DX mode is selected, and a search operation restarts with the same frequency as for the previous search. If the SEEK UP key is pressed during a search in DX mode, the search operation ends, and the frequency at which the search operation began is selected.</p> <p>When using the SEEK UP key, set the AUTO500 initial setting diode to 0. Setting it to 1 disables the SEEK UP key.</p> <p>The SEEK UP key functions during the search operation as follows:</p> <table border="1" data-bbox="349 955 1356 1879" style="width: 100%; border-collapse: collapse;"> <thead> <tr> <th style="width: 20%;">Key</th> <th>Description</th> </tr> </thead> <tbody> <tr> <td style="border: 1px solid black; padding: 2px;">SEEK UP</td> <td>When the SEEK UP key is pressed in seek-up mode, the seek operation stops, and the frequency at which the search operation began is selected. If the auto local function is being used when the key is pressed, local mode is switched.</td> </tr> <tr> <td style="border: 1px solid black; padding: 2px;">MAN UP MAN DWN</td> <td>One of the following operations occurs depending on the state of the AUTO500 initial setting diode. (1) When AUTO500 = 0: A manual tuning operation begins at the frequency that is in the frequency counter when the key is pressed. (2) When AUTO500 = 1: If the MAN UP key is pressed in seek-up mode, the seek operation stops, and the frequency that was selected when the seek operation began is reselected. If the auto local function is being used, local mode is switched.</td> </tr> <tr> <td style="border: 1px solid black; padding: 2px;">SCAN UP SCAN DWN P.SCAN</td> <td>The seek operation stops, and the operation corresponding to the pressed key begins at the frequency that was selected when the key was pressed.</td> </tr> <tr> <td style="border: 1px solid black; padding: 2px;">BAND</td> <td>In radio, radio-monitor tape, and radio-monitor CD modes, the seek operation stops. The frequency that was selected when the seek operation began is reselected, and the operation corresponding to the pressed key begins.</td> </tr> <tr> <td style="border: 1px solid black; padding: 2px;">RDMONI</td> <td>Either of the following operations occurs according to what the current mode is. (1) In radio-monitor tape and radio-monitor CD modes The seek operation stops. The frequency that was selected when the seek operation began is reselected, and the operation corresponding to the pressed key begins. (2) In radio mode The seek operation continues, and the key becomes an ineffective key.</td> </tr> </tbody> </table>	Key	Description	SEEK UP	When the SEEK UP key is pressed in seek-up mode, the seek operation stops, and the frequency at which the search operation began is selected. If the auto local function is being used when the key is pressed, local mode is switched.	MAN UP MAN DWN	One of the following operations occurs depending on the state of the AUTO500 initial setting diode. (1) When AUTO500 = 0: A manual tuning operation begins at the frequency that is in the frequency counter when the key is pressed. (2) When AUTO500 = 1: If the MAN UP key is pressed in seek-up mode, the seek operation stops, and the frequency that was selected when the seek operation began is reselected. If the auto local function is being used, local mode is switched.	SCAN UP SCAN DWN P.SCAN	The seek operation stops, and the operation corresponding to the pressed key begins at the frequency that was selected when the key was pressed.	BAND	In radio, radio-monitor tape, and radio-monitor CD modes, the seek operation stops. The frequency that was selected when the seek operation began is reselected, and the operation corresponding to the pressed key begins.	RDMONI	Either of the following operations occurs according to what the current mode is. (1) In radio-monitor tape and radio-monitor CD modes The seek operation stops. The frequency that was selected when the seek operation began is reselected, and the operation corresponding to the pressed key begins. (2) In radio mode The seek operation continues, and the key becomes an ineffective key.
Key	Description												
SEEK UP	When the SEEK UP key is pressed in seek-up mode, the seek operation stops, and the frequency at which the search operation began is selected. If the auto local function is being used when the key is pressed, local mode is switched.												
MAN UP MAN DWN	One of the following operations occurs depending on the state of the AUTO500 initial setting diode. (1) When AUTO500 = 0: A manual tuning operation begins at the frequency that is in the frequency counter when the key is pressed. (2) When AUTO500 = 1: If the MAN UP key is pressed in seek-up mode, the seek operation stops, and the frequency that was selected when the seek operation began is reselected. If the auto local function is being used, local mode is switched.												
SCAN UP SCAN DWN P.SCAN	The seek operation stops, and the operation corresponding to the pressed key begins at the frequency that was selected when the key was pressed.												
BAND	In radio, radio-monitor tape, and radio-monitor CD modes, the seek operation stops. The frequency that was selected when the seek operation began is reselected, and the operation corresponding to the pressed key begins.												
RDMONI	Either of the following operations occurs according to what the current mode is. (1) In radio-monitor tape and radio-monitor CD modes The seek operation stops. The frequency that was selected when the seek operation began is reselected, and the operation corresponding to the pressed key begins. (2) In radio mode The seek operation continues, and the key becomes an ineffective key.												

Momentary key	Description																		
<p>SEEK UP</p>	<table border="1"> <thead> <tr> <th data-bbox="423 228 586 275">Key</th> <th data-bbox="586 228 1430 275">Description</th> </tr> </thead> <tbody> <tr> <td data-bbox="423 275 586 422"> <p>LOUD/ ILLUMI- NATION POWER</p> </td> <td data-bbox="586 275 1430 422"> <p>The seek operation continues, and the operation corresponding to the pressed key begins.</p> </td> </tr> <tr> <td data-bbox="423 422 586 663"> <p>MONO/LOC</p> </td> <td data-bbox="586 422 1430 663"> <p>Either of the following operations occurs depending on the state of the AUTOLOC initial setting diode.</p> <p>(1) When AUTOLOC = 0: The seek operation continues, and the operation corresponding to the key begins.</p> <p>(2) When AUTOLOC = 1: The seek operation continues, and the pressed key becomes invalid.</p> </td> </tr> <tr> <td data-bbox="423 663 586 772"> <p>M1 to M6</p> </td> <td data-bbox="586 663 1430 772"> <p>The seek operation stops. The set tunes itself to the frequency recorded in the preset memory corresponding to the pressed key.</p> </td> </tr> </tbody> </table>	Key	Description	<p>LOUD/ ILLUMI- NATION POWER</p>	<p>The seek operation continues, and the operation corresponding to the pressed key begins.</p>	<p>MONO/LOC</p>	<p>Either of the following operations occurs depending on the state of the AUTOLOC initial setting diode.</p> <p>(1) When AUTOLOC = 0: The seek operation continues, and the operation corresponding to the key begins.</p> <p>(2) When AUTOLOC = 1: The seek operation continues, and the pressed key becomes invalid.</p>	<p>M1 to M6</p>	<p>The seek operation stops. The set tunes itself to the frequency recorded in the preset memory corresponding to the pressed key.</p>										
Key	Description																		
<p>LOUD/ ILLUMI- NATION POWER</p>	<p>The seek operation continues, and the operation corresponding to the pressed key begins.</p>																		
<p>MONO/LOC</p>	<p>Either of the following operations occurs depending on the state of the AUTOLOC initial setting diode.</p> <p>(1) When AUTOLOC = 0: The seek operation continues, and the operation corresponding to the key begins.</p> <p>(2) When AUTOLOC = 1: The seek operation continues, and the pressed key becomes invalid.</p>																		
<p>M1 to M6</p>	<p>The seek operation stops. The set tunes itself to the frequency recorded in the preset memory corresponding to the pressed key.</p>																		
<p>VOL DWN</p>	<p>The VOL DWN key is used to adjust the volume of sound in each electronic volume control mode. The operation depends on the state of the VKYSEL initial setting diode.</p> <table border="1"> <thead> <tr> <th data-bbox="423 894 537 961">VKYSEL</th> <th data-bbox="537 894 1430 961">Description</th> </tr> </thead> <tbody> <tr> <td data-bbox="423 961 537 1570"> <p>0</p> </td> <td data-bbox="537 961 1430 1570"> <p>Pressing the VOL DWN key in a mode other than an electronic volume control mode selects volume mode and increases the volume of sound.</p> <p>In an electronic volume control mode selected by the VOL SEL key, pressing the VOL DWN key activates the operation corresponding to the selected mode as follows:</p> <table border="1"> <thead> <tr> <th data-bbox="570 1119 699 1171">Mode</th> <th data-bbox="699 1119 1373 1171">Function</th> </tr> </thead> <tbody> <tr> <td data-bbox="570 1171 699 1224">Volume</td> <td data-bbox="699 1171 1373 1224">Decreases the main sound volume.</td> </tr> <tr> <td data-bbox="570 1224 699 1276">Bass</td> <td data-bbox="699 1224 1373 1276">Decreases the bass.</td> </tr> <tr> <td data-bbox="570 1276 699 1329">Treble</td> <td data-bbox="699 1276 1373 1329">Decreases the treble.</td> </tr> <tr> <td data-bbox="570 1329 699 1381">Balance</td> <td data-bbox="699 1329 1373 1381">Emphasizes the sound volume from the left-side speaker.</td> </tr> <tr> <td data-bbox="570 1381 699 1434">Fader</td> <td data-bbox="699 1381 1373 1434">Emphasizes the sound volume from the rear speaker.</td> </tr> </tbody> </table> <p>Keeping the VOL DWN key pressed for at least 0.5 seconds controls the volume continuously.</p> <p>If no key is pressed for at least 3 seconds, the mode previous to the current electronic volume control mode is reselected.</p> </td> </tr> <tr> <td data-bbox="423 1570 537 1780"> <p>1</p> </td> <td data-bbox="537 1570 1430 1780"> <p>The VOL DWN key is ineffective. After an electronic volume control mode is selected using the VOL SEL key, the MAN DWN key can be used to perform the same adjustment that would be performed using the VOL DWN key.</p> <p>Pressing the MAN DWN key in a mode other than an electronic volume control mode does not select volume mode. See the descriptions of the MAN UP and MAN DWN keys for details.</p> </td> </tr> </tbody> </table> <p>(1: Shorted by the diode; 0: Open)</p>	VKYSEL	Description	<p>0</p>	<p>Pressing the VOL DWN key in a mode other than an electronic volume control mode selects volume mode and increases the volume of sound.</p> <p>In an electronic volume control mode selected by the VOL SEL key, pressing the VOL DWN key activates the operation corresponding to the selected mode as follows:</p> <table border="1"> <thead> <tr> <th data-bbox="570 1119 699 1171">Mode</th> <th data-bbox="699 1119 1373 1171">Function</th> </tr> </thead> <tbody> <tr> <td data-bbox="570 1171 699 1224">Volume</td> <td data-bbox="699 1171 1373 1224">Decreases the main sound volume.</td> </tr> <tr> <td data-bbox="570 1224 699 1276">Bass</td> <td data-bbox="699 1224 1373 1276">Decreases the bass.</td> </tr> <tr> <td data-bbox="570 1276 699 1329">Treble</td> <td data-bbox="699 1276 1373 1329">Decreases the treble.</td> </tr> <tr> <td data-bbox="570 1329 699 1381">Balance</td> <td data-bbox="699 1329 1373 1381">Emphasizes the sound volume from the left-side speaker.</td> </tr> <tr> <td data-bbox="570 1381 699 1434">Fader</td> <td data-bbox="699 1381 1373 1434">Emphasizes the sound volume from the rear speaker.</td> </tr> </tbody> </table> <p>Keeping the VOL DWN key pressed for at least 0.5 seconds controls the volume continuously.</p> <p>If no key is pressed for at least 3 seconds, the mode previous to the current electronic volume control mode is reselected.</p>	Mode	Function	Volume	Decreases the main sound volume.	Bass	Decreases the bass.	Treble	Decreases the treble.	Balance	Emphasizes the sound volume from the left-side speaker.	Fader	Emphasizes the sound volume from the rear speaker.	<p>1</p>	<p>The VOL DWN key is ineffective. After an electronic volume control mode is selected using the VOL SEL key, the MAN DWN key can be used to perform the same adjustment that would be performed using the VOL DWN key.</p> <p>Pressing the MAN DWN key in a mode other than an electronic volume control mode does not select volume mode. See the descriptions of the MAN UP and MAN DWN keys for details.</p>
VKYSEL	Description																		
<p>0</p>	<p>Pressing the VOL DWN key in a mode other than an electronic volume control mode selects volume mode and increases the volume of sound.</p> <p>In an electronic volume control mode selected by the VOL SEL key, pressing the VOL DWN key activates the operation corresponding to the selected mode as follows:</p> <table border="1"> <thead> <tr> <th data-bbox="570 1119 699 1171">Mode</th> <th data-bbox="699 1119 1373 1171">Function</th> </tr> </thead> <tbody> <tr> <td data-bbox="570 1171 699 1224">Volume</td> <td data-bbox="699 1171 1373 1224">Decreases the main sound volume.</td> </tr> <tr> <td data-bbox="570 1224 699 1276">Bass</td> <td data-bbox="699 1224 1373 1276">Decreases the bass.</td> </tr> <tr> <td data-bbox="570 1276 699 1329">Treble</td> <td data-bbox="699 1276 1373 1329">Decreases the treble.</td> </tr> <tr> <td data-bbox="570 1329 699 1381">Balance</td> <td data-bbox="699 1329 1373 1381">Emphasizes the sound volume from the left-side speaker.</td> </tr> <tr> <td data-bbox="570 1381 699 1434">Fader</td> <td data-bbox="699 1381 1373 1434">Emphasizes the sound volume from the rear speaker.</td> </tr> </tbody> </table> <p>Keeping the VOL DWN key pressed for at least 0.5 seconds controls the volume continuously.</p> <p>If no key is pressed for at least 3 seconds, the mode previous to the current electronic volume control mode is reselected.</p>	Mode	Function	Volume	Decreases the main sound volume.	Bass	Decreases the bass.	Treble	Decreases the treble.	Balance	Emphasizes the sound volume from the left-side speaker.	Fader	Emphasizes the sound volume from the rear speaker.						
Mode	Function																		
Volume	Decreases the main sound volume.																		
Bass	Decreases the bass.																		
Treble	Decreases the treble.																		
Balance	Emphasizes the sound volume from the left-side speaker.																		
Fader	Emphasizes the sound volume from the rear speaker.																		
<p>1</p>	<p>The VOL DWN key is ineffective. After an electronic volume control mode is selected using the VOL SEL key, the MAN DWN key can be used to perform the same adjustment that would be performed using the VOL DWN key.</p> <p>Pressing the MAN DWN key in a mode other than an electronic volume control mode does not select volume mode. See the descriptions of the MAN UP and MAN DWN keys for details.</p>																		

Momentary key	Description																								
<div style="border: 1px solid black; padding: 2px; width: fit-content; margin-bottom: 5px;">VOL SEL</div>	<p>The VOL SEL key is used to select an electronic volume control mode. There are five electronic volume control modes as listed below:</p> <table border="1" data-bbox="349 283 1356 630"> <thead> <tr> <th>Mode</th> <th>Function</th> <th>Panel display (initial setting)</th> </tr> </thead> <tbody> <tr> <td>Volume</td> <td>Controls the main sound volume.</td> <td>VOL 16</td> </tr> <tr> <td>Bass</td> <td>Controls the bass.</td> <td>BAS 0</td> </tr> <tr> <td>Treble</td> <td>Controls the treble.</td> <td>TRE 0</td> </tr> <tr> <td>Balance</td> <td>Controls the sound volume from the right- and left-side speakers.</td> <td>BA C 0</td> </tr> <tr> <td>Fader</td> <td>Controls the sound volume from the front and rear speakers.</td> <td>FA C 0</td> </tr> </tbody> </table> <p>Either of the modes listed below is selected depending on the state of the VKYSEL initial setting diode. Each time the VOL SEL key is pressed, the mode switches as listed below.</p> <table border="1" data-bbox="349 735 1356 1302"> <thead> <tr> <th>VKYSEL</th> <th>Description</th> </tr> </thead> <tbody> <tr> <td>0</td> <td> <p>The first mode selected is bass mode.</p> <p>VOL SEL</p> <p>1 PUSH</p> <pre> -----> Bass -----> Tremble -----> Balance START ↑ Volume ←----- Fader </pre> </td> </tr> <tr> <td>1</td> <td> <p>The first mode selected is volume mode.</p> <p>VOL SEL</p> <p>1 PUSH</p> <pre> -----> Volume -----> Bass -----> Treble START ↑ Fader ←----- Balance </pre> </td> </tr> </tbody> </table> <p>(1: Shorted by the diode; 0: Open)</p>	Mode	Function	Panel display (initial setting)	Volume	Controls the main sound volume.	VOL 16	Bass	Controls the bass.	BAS 0	Treble	Controls the treble.	TRE 0	Balance	Controls the sound volume from the right- and left-side speakers.	BA C 0	Fader	Controls the sound volume from the front and rear speakers.	FA C 0	VKYSEL	Description	0	<p>The first mode selected is bass mode.</p> <p>VOL SEL</p> <p>1 PUSH</p> <pre> -----> Bass -----> Tremble -----> Balance START ↑ Volume ←----- Fader </pre>	1	<p>The first mode selected is volume mode.</p> <p>VOL SEL</p> <p>1 PUSH</p> <pre> -----> Volume -----> Bass -----> Treble START ↑ Fader ←----- Balance </pre>
Mode	Function	Panel display (initial setting)																							
Volume	Controls the main sound volume.	VOL 16																							
Bass	Controls the bass.	BAS 0																							
Treble	Controls the treble.	TRE 0																							
Balance	Controls the sound volume from the right- and left-side speakers.	BA C 0																							
Fader	Controls the sound volume from the front and rear speakers.	FA C 0																							
VKYSEL	Description																								
0	<p>The first mode selected is bass mode.</p> <p>VOL SEL</p> <p>1 PUSH</p> <pre> -----> Bass -----> Tremble -----> Balance START ↑ Volume ←----- Fader </pre>																								
1	<p>The first mode selected is volume mode.</p> <p>VOL SEL</p> <p>1 PUSH</p> <pre> -----> Volume -----> Bass -----> Treble START ↑ Fader ←----- Balance </pre>																								

Momentary key	Description																		
<div style="border: 1px solid black; padding: 2px; width: fit-content; margin-bottom: 5px;">VOL UP</div>	<p>The VOL UP key is used to adjust the volume of sound in each electronic volume control mode. The operation depends on the state of the VKYSEL initial setting diode.</p> <table border="1" style="width: 100%; border-collapse: collapse;"> <thead> <tr> <th style="width: 15%;">VKYSEL</th> <th>Description</th> </tr> </thead> <tbody> <tr> <td style="text-align: center; vertical-align: top;">0</td> <td> <p>Pressing the VOL UP key in a mode other than an electronic volume control mode selects volume mode and increases the volume of sound.</p> <p>In an electronic volume control mode selected by the VOL SEL key, pressing the VOL UP key activates the operation corresponding to the selected mode as follows:</p> <table border="1" style="width: 100%; border-collapse: collapse; margin: 10px 0;"> <thead> <tr> <th style="width: 20%;">Mode</th> <th>Function</th> </tr> </thead> <tbody> <tr> <td>Volume</td> <td>Increases the main sound volume.</td> </tr> <tr> <td>Bass</td> <td>Increases the bass.</td> </tr> <tr> <td>Treble</td> <td>Increases the treble.</td> </tr> <tr> <td>Balance</td> <td>Emphasizes the sound volume from the right-side speaker.</td> </tr> <tr> <td>Fader</td> <td>Emphasizes the sound volume from the front speaker.</td> </tr> </tbody> </table> <p>Keeping the VOL UP key pressed for at least 0.5 seconds controls the volume continuously.</p> <p>If no key is pressed for at least 3 seconds, the mode previous to the current electronic volume control mode is reselected.</p> </td> </tr> <tr> <td style="text-align: center; vertical-align: top;">1</td> <td> <p>The VOL UP key is ineffective. After an electronic volume control mode is selected using the VOL SEL key, the MAN UP key can be used to perform the same adjustment that would be performed using the VOL UP key.</p> <p>Pressing the MAN UP key in a mode other than an electronic volume control mode does not select volume mode. See the descriptions of the MAN UP and MAN DWN keys for details.</p> </td> </tr> </tbody> </table> <p>(1: Shorted by the diode; 0: Open)</p>	VKYSEL	Description	0	<p>Pressing the VOL UP key in a mode other than an electronic volume control mode selects volume mode and increases the volume of sound.</p> <p>In an electronic volume control mode selected by the VOL SEL key, pressing the VOL UP key activates the operation corresponding to the selected mode as follows:</p> <table border="1" style="width: 100%; border-collapse: collapse; margin: 10px 0;"> <thead> <tr> <th style="width: 20%;">Mode</th> <th>Function</th> </tr> </thead> <tbody> <tr> <td>Volume</td> <td>Increases the main sound volume.</td> </tr> <tr> <td>Bass</td> <td>Increases the bass.</td> </tr> <tr> <td>Treble</td> <td>Increases the treble.</td> </tr> <tr> <td>Balance</td> <td>Emphasizes the sound volume from the right-side speaker.</td> </tr> <tr> <td>Fader</td> <td>Emphasizes the sound volume from the front speaker.</td> </tr> </tbody> </table> <p>Keeping the VOL UP key pressed for at least 0.5 seconds controls the volume continuously.</p> <p>If no key is pressed for at least 3 seconds, the mode previous to the current electronic volume control mode is reselected.</p>	Mode	Function	Volume	Increases the main sound volume.	Bass	Increases the bass.	Treble	Increases the treble.	Balance	Emphasizes the sound volume from the right-side speaker.	Fader	Emphasizes the sound volume from the front speaker.	1	<p>The VOL UP key is ineffective. After an electronic volume control mode is selected using the VOL SEL key, the MAN UP key can be used to perform the same adjustment that would be performed using the VOL UP key.</p> <p>Pressing the MAN UP key in a mode other than an electronic volume control mode does not select volume mode. See the descriptions of the MAN UP and MAN DWN keys for details.</p>
VKYSEL	Description																		
0	<p>Pressing the VOL UP key in a mode other than an electronic volume control mode selects volume mode and increases the volume of sound.</p> <p>In an electronic volume control mode selected by the VOL SEL key, pressing the VOL UP key activates the operation corresponding to the selected mode as follows:</p> <table border="1" style="width: 100%; border-collapse: collapse; margin: 10px 0;"> <thead> <tr> <th style="width: 20%;">Mode</th> <th>Function</th> </tr> </thead> <tbody> <tr> <td>Volume</td> <td>Increases the main sound volume.</td> </tr> <tr> <td>Bass</td> <td>Increases the bass.</td> </tr> <tr> <td>Treble</td> <td>Increases the treble.</td> </tr> <tr> <td>Balance</td> <td>Emphasizes the sound volume from the right-side speaker.</td> </tr> <tr> <td>Fader</td> <td>Emphasizes the sound volume from the front speaker.</td> </tr> </tbody> </table> <p>Keeping the VOL UP key pressed for at least 0.5 seconds controls the volume continuously.</p> <p>If no key is pressed for at least 3 seconds, the mode previous to the current electronic volume control mode is reselected.</p>	Mode	Function	Volume	Increases the main sound volume.	Bass	Increases the bass.	Treble	Increases the treble.	Balance	Emphasizes the sound volume from the right-side speaker.	Fader	Emphasizes the sound volume from the front speaker.						
Mode	Function																		
Volume	Increases the main sound volume.																		
Bass	Increases the bass.																		
Treble	Increases the treble.																		
Balance	Emphasizes the sound volume from the right-side speaker.																		
Fader	Emphasizes the sound volume from the front speaker.																		
1	<p>The VOL UP key is ineffective. After an electronic volume control mode is selected using the VOL SEL key, the MAN UP key can be used to perform the same adjustment that would be performed using the VOL UP key.</p> <p>Pressing the MAN UP key in a mode other than an electronic volume control mode does not select volume mode. See the descriptions of the MAN UP and MAN DWN keys for details.</p>																		

3. ALARM FUNCTION

The alarm function is provided as a means of preventing car theft. If the alarm system detects anyone other than the user entering the car, a warning sound is generated.

3.1 Overview of the Alarm Function

- When alarm mode is off



- When alarm mode is on

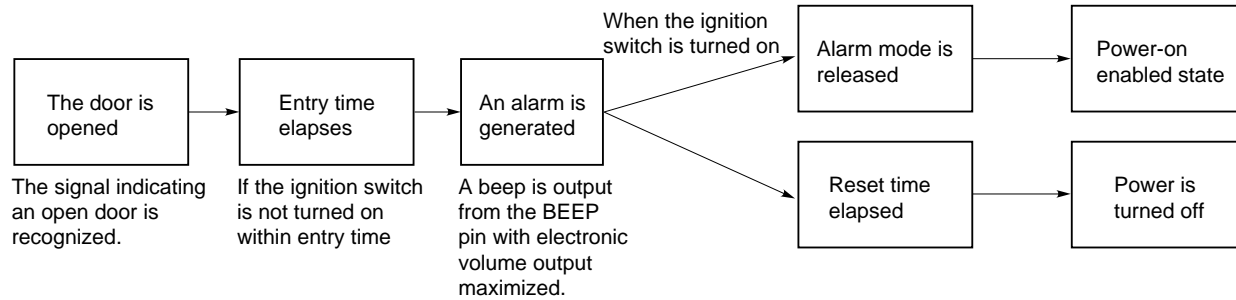

3.2 Setting Alarm Mode

Alarm mode is set as follows:

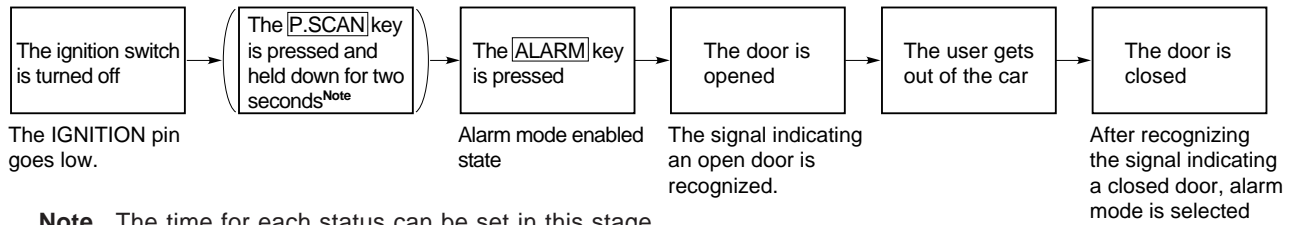

Note The time for each status can be set in this stage.

Press and hold down the **P.SCAN** key for two seconds. Then each time the key is pressed, the status changes in the order of the exit time, entry time, reset time, and setting end.

	Initial value (s)	Specificate value (s)
Exit time	12	3 to 180
Entry time	12	3 to 180
Reset time	30	3 to 180

Exit time : Time between opening and closing the door after pressing the **ALARM** key

Entry time : Time between opening the door and turning on the ignition switch

Reset time : Time during which an alarm sound is generated in alarm mode

To set alarm mode, the following pins and keys in (1) to (7) are used.

(1) IGNITION pin

The ignition switch signal is input from the key box.

IGNITION pin	State
At the low level	<ul style="list-style-type: none"> • Power-off • Alarm mode on (alarm being output) and alarm mode time setting enabled • In alarm mode
At the high level	Power-on enabled state

(2) ALARMIN pin

The signal indicating that the car door is open or closed is input.

- When the **ALARM** key has been turned on with the ALARMIN pin at the low level

ALARMIN pin	State
At the low level	The door is closed.
At the high level	The door is open.

- When the **ALARM** key has been turned on with the ALARMIN pin at the high level

ALARMIN pin	State
At the low level	The door is open.
At the high level	The door is closed.

(3) ALARMOUT pin

The state upon warning is output.

This pin is used as a power-on signal for the peripheral hardware, such as an electronic volume control or amplifier.

ALARMIN pin	State
At the low level	Alarm mode off
At the high level	Alarm mode on (alarm being output)

(4) ALARM key

When this key is pressed with both of the following conditions satisfied, the alarm function is activated.

- The ignition switch is off.
- The DISALARM initial setting diode is set to 0.

The **ALARM** key is effective only when the IGNITION pin = 0.

(5) P.SCAN key

When this key is pressed and held down for two seconds or more with both of the following conditions satisfied, the system enters the alarm time setting state.

- The ignition switch is off.
- The DISALARM initial setting diode is set to 0.

(6) MAN UP key

When this key is pressed in the alarm time setting state, the set time is incremented by one step (one second).
When this key is pressed and held down for two seconds or more, the set time is incremented continuously at a rate of one step per 50 ms.

(7) MAN DWN key

When this key is pressed in the alarm time setting state, the set time is decremented by one step (one second).
When this key is pressed and held down for two seconds or more, the set time is decremented continuously at a rate of one step per 50 ms.

Figure 3-1 outlines the setting and operation of alarm mode. Figures 3-2 to 3-4 show the transition of the alarm operations.

Figure 3-1. Outline of Setting and Operation of Alarm Mode

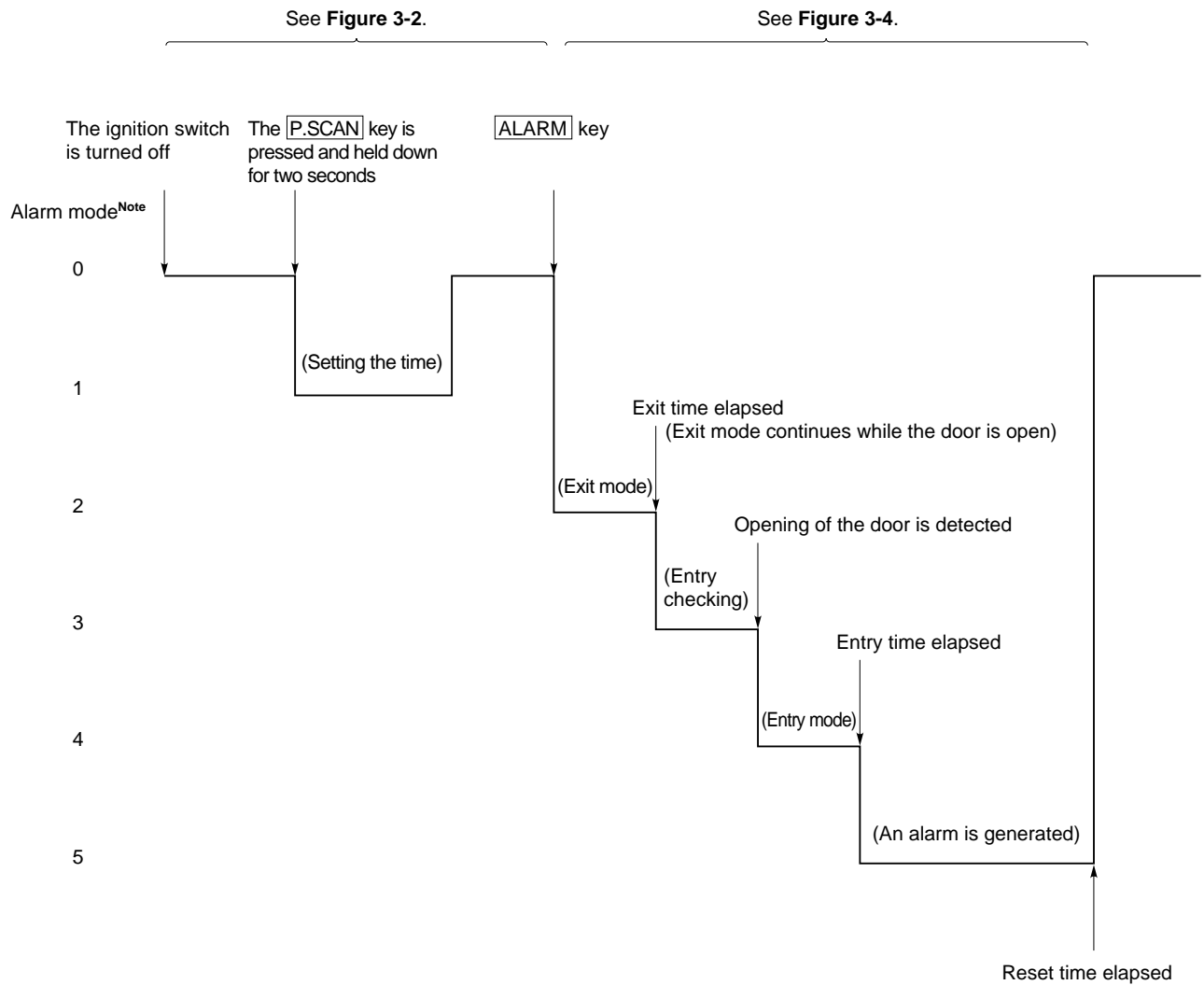

- Note**
- 0: Alarm operation being halted
 - 1: During alarm time setting (setting of the time for exit, entry, and reset)
 - 2: During exit operation
 - 3: During entry checking
 - 4: During entry operation
 - 5: Alarm being generated

Figure 3-2. Transition of Alarm Operations 1 (While Alarm Operation Is Halted)

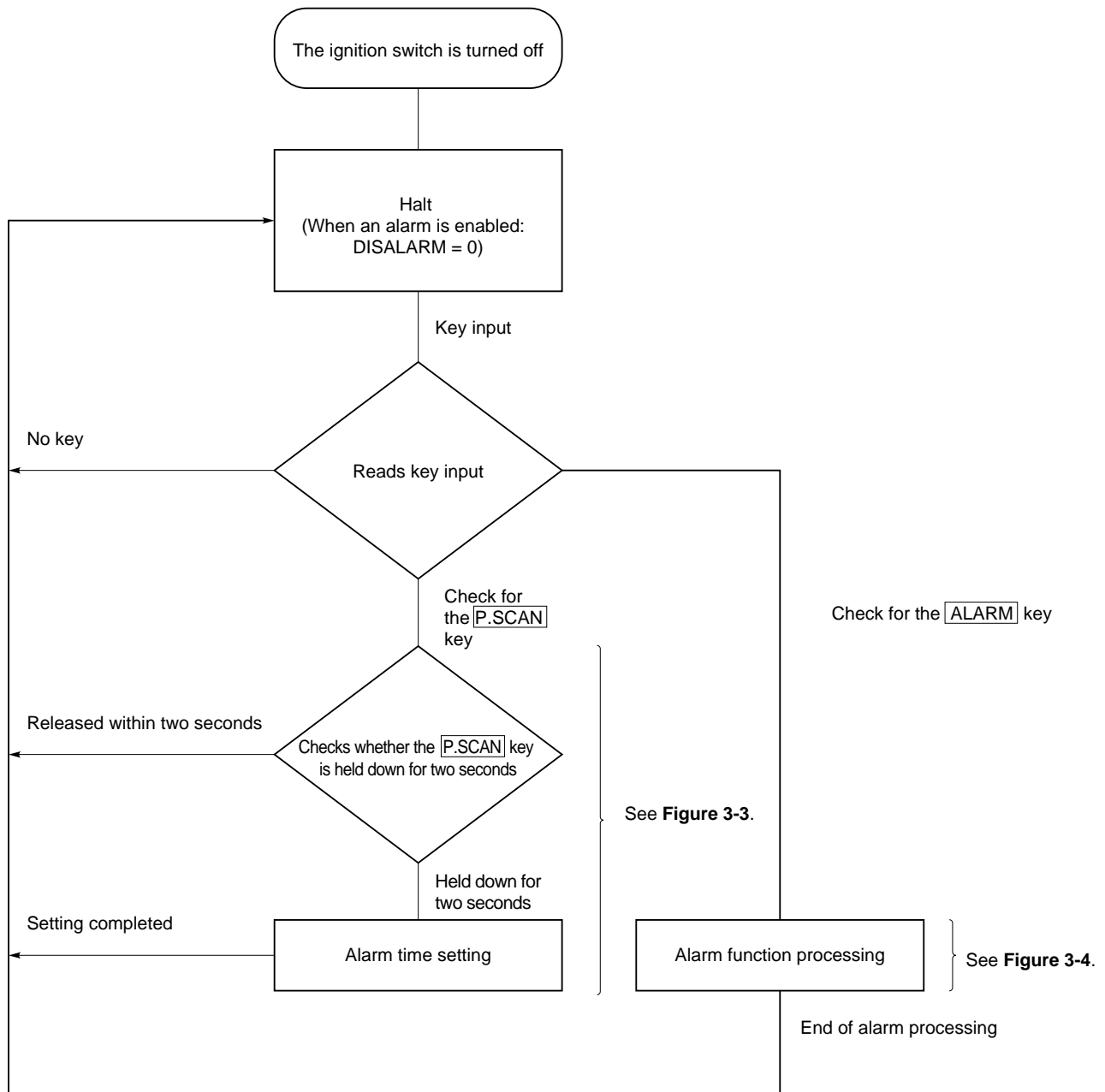
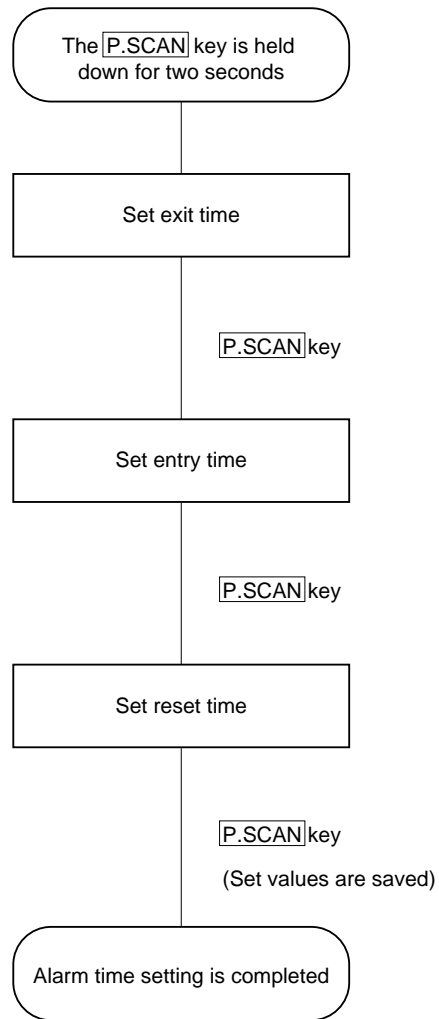
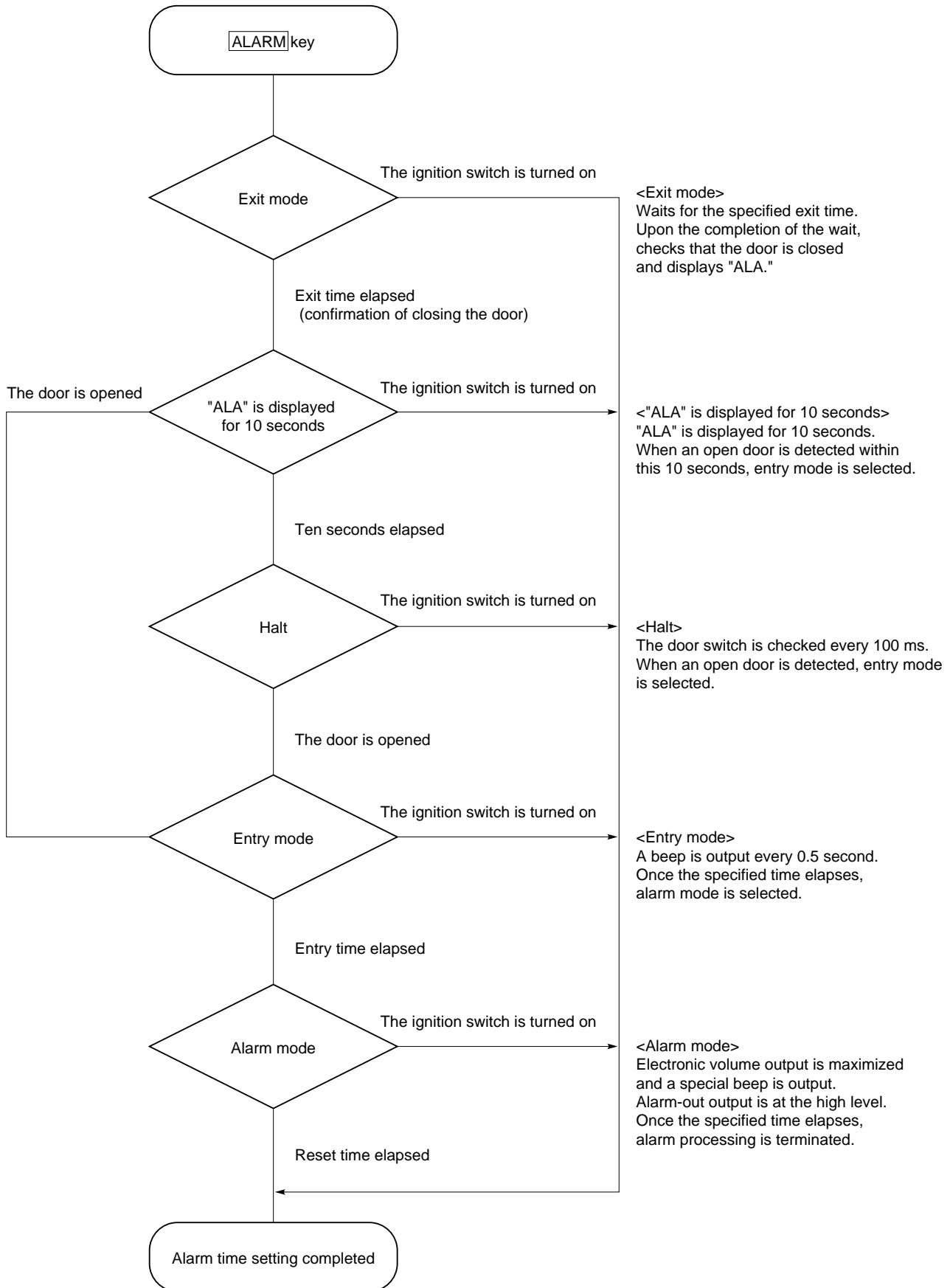

Figure 3-3. Transition of Alarm Operations 2 (Alarm Time Setting)



	Initial value (s)	Specifiable value (s)
Exit time	12	3 to 180
Entry time	12	3 to 180
Reset time	30	3 to 180

Figure 3-4. Transition of Alarm Operations 3 (During Alarm Function Processing)



4. MODE TRANSITION

The radio set is turned on or off by switching the RDSET switch.

The RDSET, TPSET, and CDSET switches are enabled only when the CE and IGNITION pins are high.

When the IGNITION pin is made low, clock display is not provided regardless of state of the initial setting diode NOCLK. However, when NOCLK = 0 (for using the clock), the clock operates.

Transition to alarm mode is possible when the IGNITION pin is at a low level.

The CE pin must be fixed to a high level.

(1) Mode transition when the IGNITION pin is raised from low to high

The RDSET switch is used to turn on or off radio mode.

The TPSET and CDSET switches are used to switch to tape mode and CD mode.

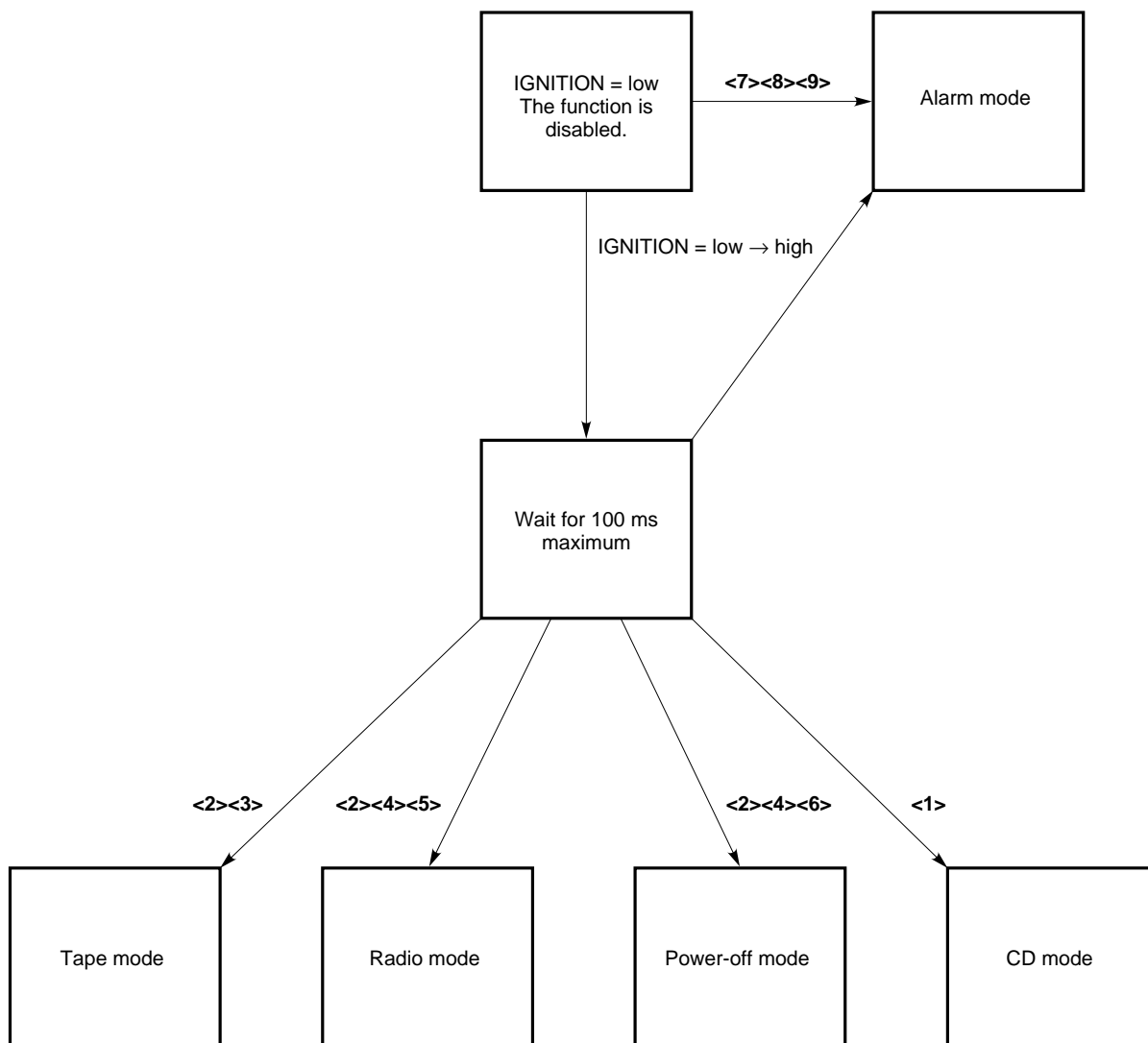

Remark The numbers in brackets (< >) represent the following:

- <1>: CDSET switch on
- <2>: CDSET switch off
- <3>: TPSET switch on
- <4>: TPSET switch off
- <5>: RDSET switch on
- <6>: RDSET switch off
- <7>: IGNITION pin off (low level)
- <8>: ALARM key on
- <9>: DISALARM switch = 0

(2) Mode transition when the IGNITION pin is held high

(a) Transition from radio mode to another mode

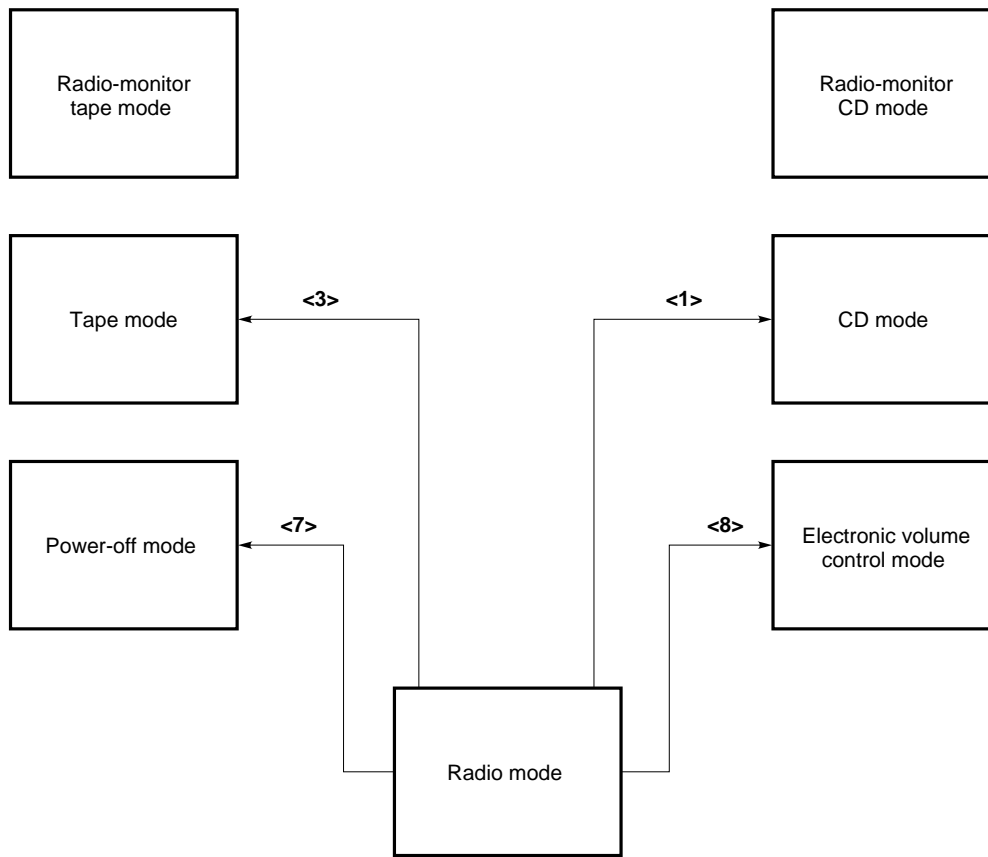

Remark The numbers in brackets (< >) represent the following:

<1>: CDSET switch on	<5>: RDMONI key on
<2>: CDSET switch off	<6>: RDSET switch on
<3>: TPSET switch on	<7>: RDSET switch off
<4>: TPSET switch off	<8>: Electronic volume control key on

(b) Transition from tape mode to another mode

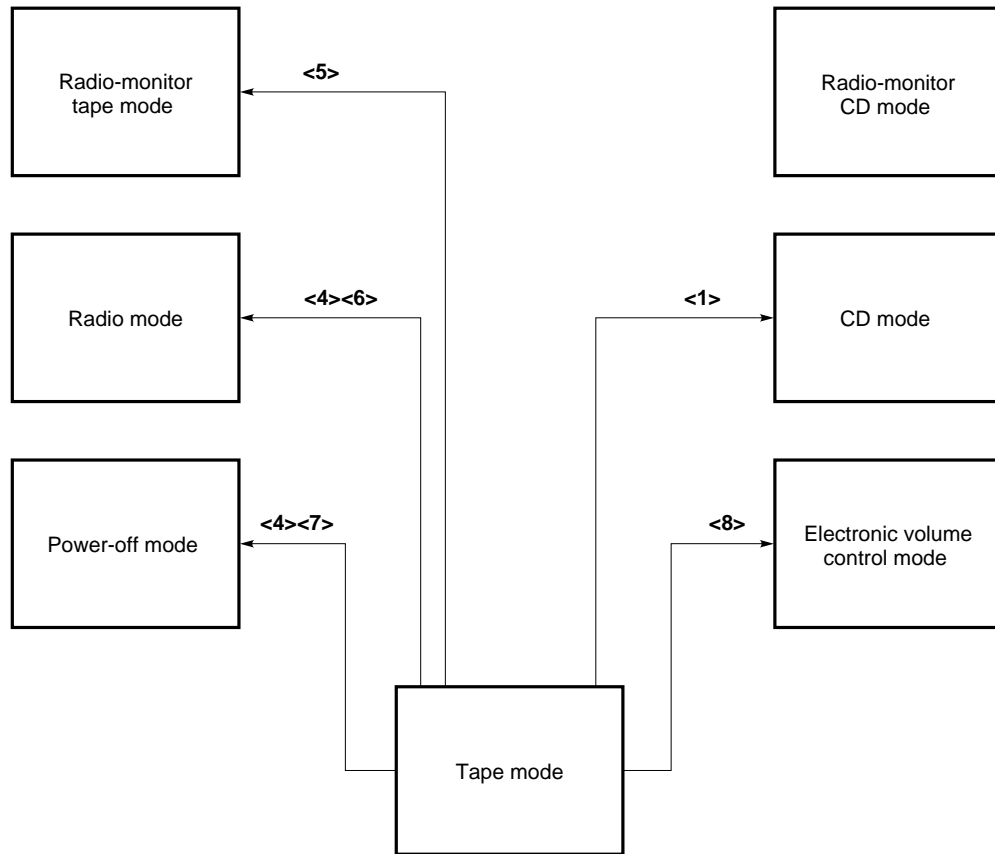

Remark The numbers in brackets (< >) represent the following:

<1>: CDSET switch on	<5>: RDMONI key on
<2>: CDSET switch off	<6>: RDSET switch on
<3>: TPSET switch on	<7>: RDSET switch off
<4>: TPSET switch off	<8>: Electronic volume control key on

(c) Transition from radio-monitor tape mode to another mode

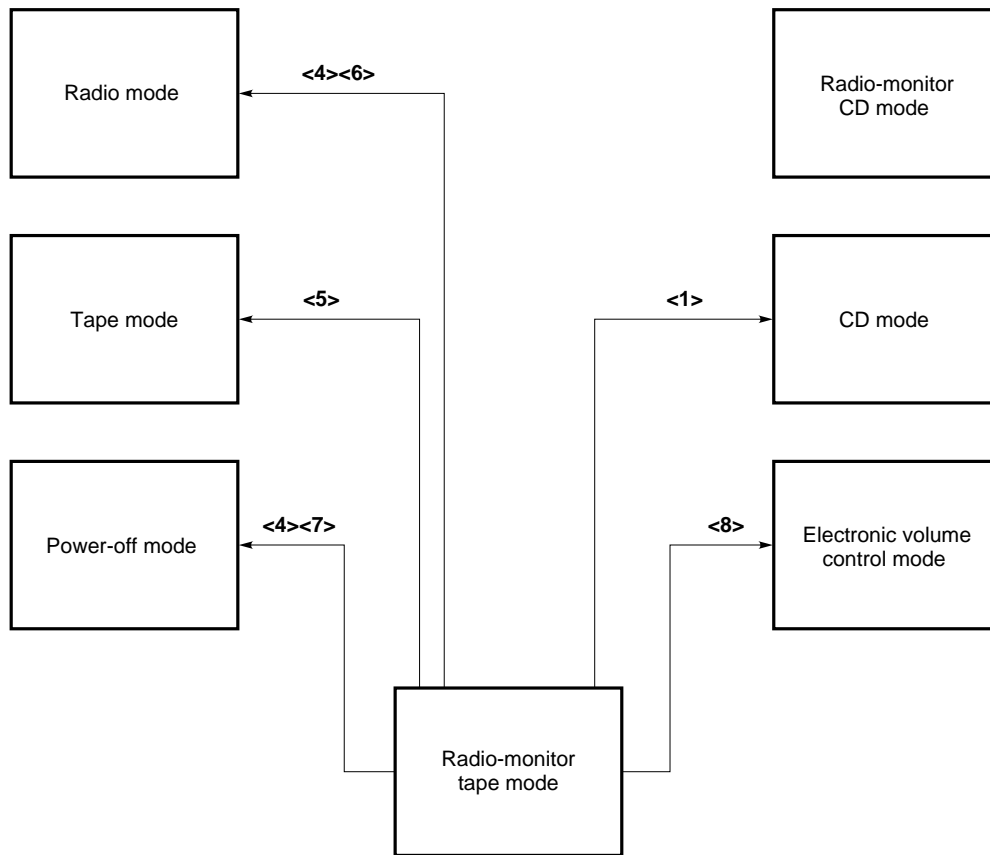

Remark The numbers in brackets (< >) represent the following:

- <1>: CDSET switch on
- <2>: CDSET switch off
- <3>: TPSET switch on
- <4>: TPSET switch off
- <5>: RDMONI key on
- <6>: RDSET switch on
- <7>: RDSET switch off
- <8>: Electronic volume control key on

(d) Transition from CD mode to another mode

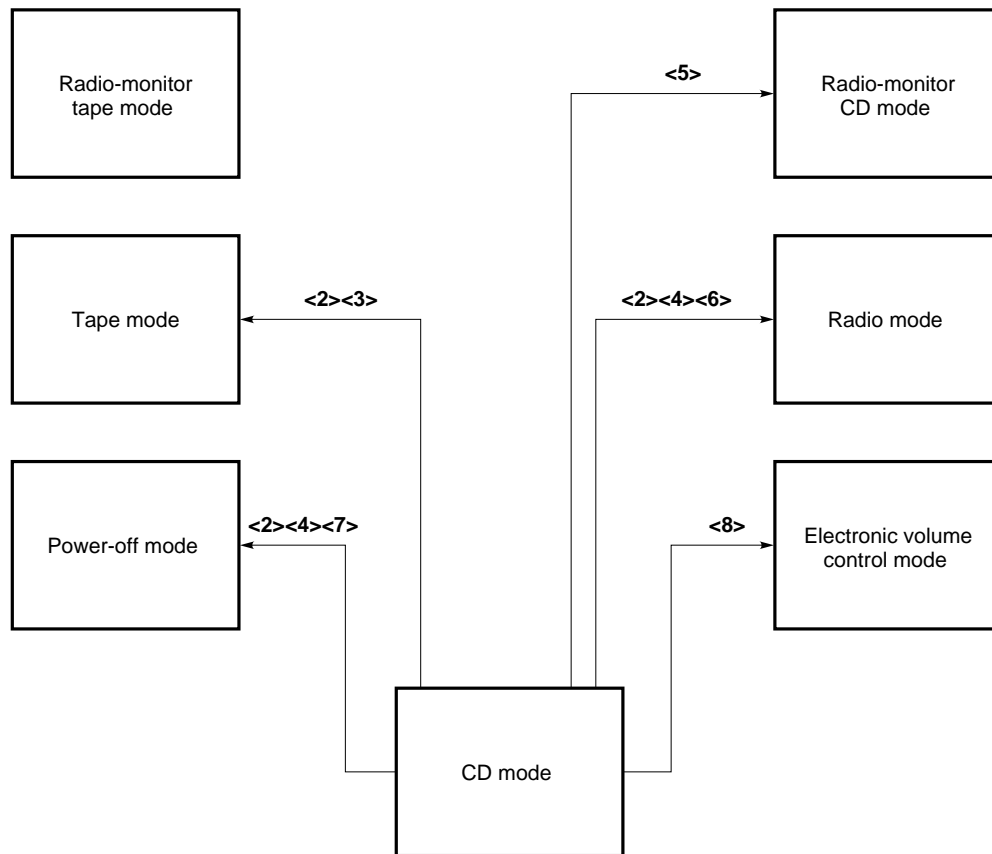

Remark The numbers in brackets (< >) represent the following:

<1>: CDSET switch on	<5>: RDMONI key on
<2>: CDSET switch off	<6>: RDSET switch on
<3>: TPSET switch on	<7>: RDSET switch off
<4>: TPSET switch off	<8>: Electronic volume control key on

(e) Transition from radio-monitor CD mode to another mode

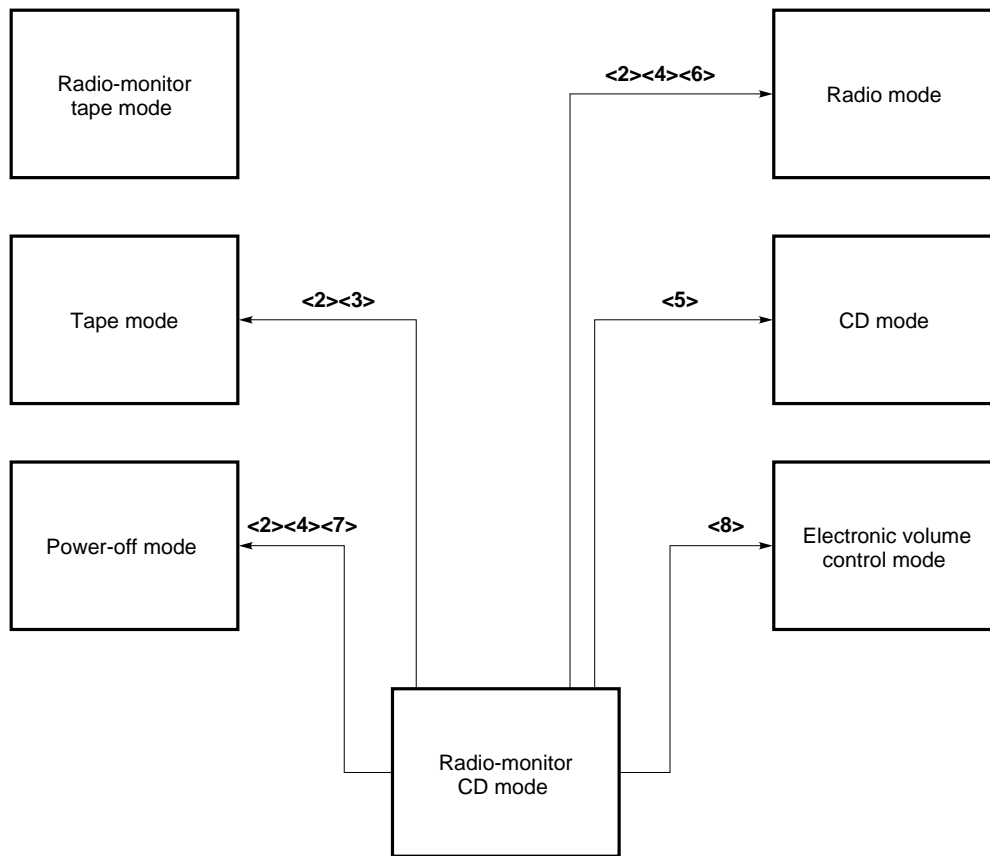

Remark The numbers in brackets (< >) represent the following:

- | | |
|-----------------------|--|
| <1>: CDSET switch on | <5>: RDMONI key on |
| <2>: CDSET switch off | <6>: RDSET switch on |
| <3>: TPSET switch on | <7>: RDSET switch off |
| <4>: TPSET switch off | <8>: Electronic volume control key on |

(f) Transition from power-off mode to another mode

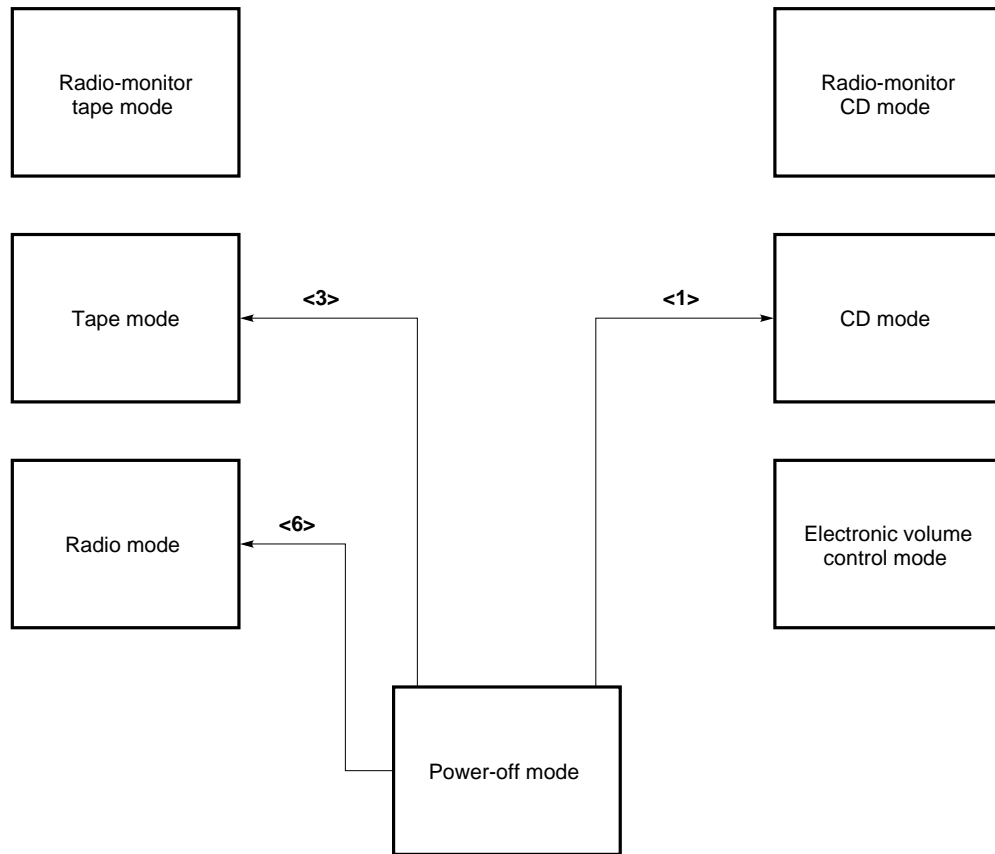

Remark The numbers in brackets (< >) represent the following:

<1>: CDSET switch on	<5>: RDMONI key on
<2>: CDSET switch off	<6>: RDSET switch on
<3>: TPSET switch on	<7>: RDSET switch off
<4>: TPSET switch off	<8>: Electronic volume control key on

5. DISPLAY

5.1 LCD Panel

ALARM ARMING EXIT ENTRY RESET
 CLASSIC NORMAL ROCK POP
 FM 1 ▶ ◀ LOC LOUD MONO ST
 FM 2
 FM 3 RDMONI MTL
 MW LW 88.8.8.85 88 AM
 CH PM

5.2 Character Style

1234567890
 ABCDEFLQPRSTW

5.3 Examples of Display

(1) Tape mode

TAPE

(4) Volume mode

VOL

(7) Balance mode

BA

(2) CD mode

CD

(5) Bass mode

BAS

(8) Fader mode

FA

(3) Auto-storage

ATP

(6) Treble mode

TRE

5.4 LCD Assignment

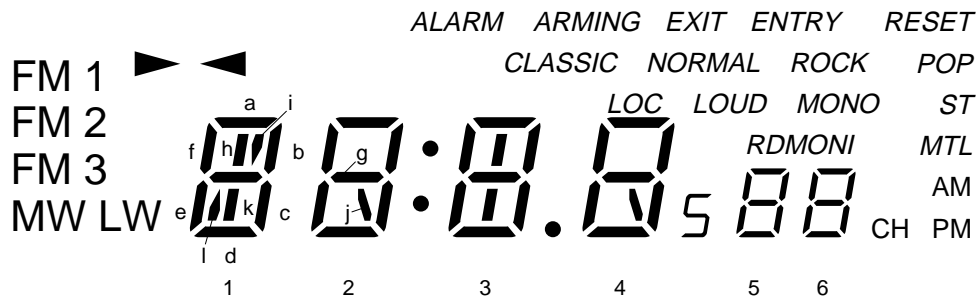



5.5 Pin Assignment of the LCD Controller/Driver (μPD7225)

Pin name (pin number) / Pin name (pin number)	COM0 (15)	COM1 (16)	COM2 (17)
S0 (19)	ST	MW	FM1
S1 (20)	◀	LW	▶
S2 (21)	POP	FM3	FM2
S3 (22)	1l, i	1d	1f
S4 (23)	1g	1e	1a
S5 (24)	1k, h	1c	1b
S6 (25)	ALARM	2e	2f
S7 (26)	2g	2d	2a
S8 (27)	2j	2c	2b
S9 (28)	:	3e	3f
S10 (29)	3g	3d	3a
S11 (30)	3h, k	3c	3b
S12 (31)	.	4e	4f
S13 (32)	4g	4d	4a
S14 (34)	4j	4c	4b
S15 (35)	AM	PM	MONO
S16 (36)	ARMING	5e	5f
S17 (37)	5g	5d	5a
S18 (38)	EXIT	5c	5b
S19 (39)	ENTRY	6e	6f
S20 (40)	6g	6d	6a
S21 (41)	RESET	6c	6b
S22 (42)	RDMONI	CH	MTL
S23 (43)	5	NORMAL	LOUD
S24 (44)	ROCK	CLASSIC	LOC

Remark The numbers in parentheses indicate the pin numbers of the μPD7225G (52-pin plastic QFP).

5.6 Description of Display

Display	Description
ALARM ARMING EXIT ENTRY RESET	Indicates the state of the alarm operation. <ul style="list-style-type: none"> • ALARM : This indication is on in alarm mode. • ARMING : This indication is on during alarm output. • EXIT : This indication is on during exit time setting. • ENTRY : This indication is on during entry time setting. • RESET : This indication is on during reset time setting.
CLASSIC NORMAL POP ROCK	Indicates the mode for the external sound control IC. <ul style="list-style-type: none"> • CLASSIC: Classic mode • NORMAL: Normal mode • POP : Pops mode • ROCK : Rock mode
ST	Indicates that a stereo broadcast is currently received. <p>(1) In CD mode or tape mode This indication is off.</p> <p>(2) In other modes This indication is on when the FM or MW band is selected, the ST switch is on in the station reception state, and the MONO-off state is set. (For the MW band, this indication is on only when the initial setting diode MWS = 1, and the stereo reception function is enabled.) This indication is off during tuning operation regardless of which band is selected.</p>
LOC	Indicates that the local state is set. <p>(1) In CD mode and tape mode This indication is off.</p> <p>(2) In other modes This indication is on in the local state.</p>
LOUD	Indicates that the loudness-on state is set. This indication is on in the loudness-on state, regardless of which mode is set.
MTL	Indicates that the METAL-on state is set. <p>(1) In tape mode and radio-monitor tape mode This indication is on in the METAL-on state.</p> <p>(2) In other modes This indication is off.</p>
RDMONI	Indicates that the radio-monitor state is set.
MONO	Indicates that the MONO state is set. <p>(1) In CD mode and tape mode This indication is off.</p> <p>(2) In other modes This indication is on when the FM or MW band is selected in the MONO-off state. (For the MW band, this indication is on only when the initial setting diode MWS = 1, and the stereo reception function is enabled.)</p>
	Indicates a tape running direction. <p>(1) In tape mode and radio-monitor tape mode A tape running direction is displayed according to the state of the RL switch. A tape running direction blinks when the FF switch is on.</p> <p>(2) In other modes This indication is off.</p>

Display	Description
FM1 FM2 FM3 MW LW	Indicates a band received. (1) In CD mode and tape mode This indication is off. (2) In other modes The band currently received is displayed.
	Displays a receive frequency, "RTP", "CD", "TAPE", "VOL", "BAS", "TRE", "BR", "FR", and the clock. When the entire panel is blinking while "VOL" is displayed, the mute state is set.
AM PM	Indicates AM (before noon) or PM (after noon) when the 12-hour system is used for display.
	Indicates a preset memory number or electronic volume control value. When a preset memory is written to or called, the preset memory number is displayed together with "CH." In a electronic volume control mode, the value of the volume control is displayed; the "CH" is turned off in this case. This indication is on when a frequency is displayed; this indication is off when the clock is displayed. When preset memory write operation is enabled, "CH" blinks at a frequency of 1 Hz. When a preset memory is being scanned, the preset memory number blinks at a frequency of 1 Hz.

6. REMOTE CONTROL FUNCTION

Use the μPD6121G for sending signals from a remote-controller. The μPD6121G incorporates a custom code. If this code is not correctly set, the μPD17012GF-058 cannot be controlled using the remote controller.

The custom code which operates the μPD17012GF-058 is 8604H. Set the code to 8604H by connecting a diode and a pull-up resistor appropriately on the key matrix of the μPD6121G. (See **Section 6.4.**)

6.1 Remote-Controller Key Placement (When the μPD6121G Is Used)

Input pin (pin number) Output pin (pin number)	KI ₀ (1)	KI ₁ (2)	KI ₂ (3)	KI ₃ (4)
KI/O ₀ (19)	M1	M2	M3	M4
KI/O ₁ (18)	M5	M6	SEEK UP	-
KI/O ₂ (17)	SCAN UP	SCAN DWN	P. SCAN	BAND
KI/O ₃ (16)	MODE	LOC	MONO	POWER
KI/O ₄ (15)	ILLUMINATION	LOUD	-	-
KI/O ₅ (14)	DISP	MAN UP	MAN DWN	-
KI/O ₆ (13)	-	-	MTL	VOL CON
KI/O ₇ (12)	VOL UP	VOL DWN	MUTE	CD

6.2 Remote-Controller Keys

The remote-controller keys operate in the same way as the momentary keys of the μPD17012GF-058.

6.3 Remote-Controller Data Codes

- When each key is pressed independently

Remote-controller key	Data code							
	D0	D1	D2	D3	D4	D5	D6	D7
M1	0	0	0	0	0	0	0	0
M2	1	0	0	0	0	0	0	0
M3	0	1	0	0	0	0	0	0
M4	1	1	0	0	0	0	0	0
M5	0	0	1	0	0	0	0	0
M6	1	0	1	0	0	0	0	0
SEEK UP	0	1	1	0	0	0	0	0
-	1	1	1	0	0	0	0	0
SCAN UP	0	0	0	1	0	0	0	0
SCAN DWN	1	0	0	1	0	0	0	0
P. SCAN	0	1	0	1	0	0	0	0
BAND	1	1	0	1	0	0	0	0
MODE	0	0	1	1	0	0	0	0
LOC	1	0	1	1	0	0	0	0
MONO	0	1	1	1	0	0	0	0
POWER	1	1	1	1	0	0	0	0

Remote-controller key	Data code							
	D0	D1	D2	D3	D4	D5	D6	D7
ILLUMINATION	0	0	0	0	1	0	0	0
LOUD	1	0	0	0	1	0	0	0
-	0	1	0	0	1	0	0	0
-	1	1	0	0	1	0	0	0
DISP	0	0	1	0	1	0	0	0
MAN UP	1	0	1	0	1	0	0	0
MAN DWN	0	1	1	0	1	0	0	0
-	1	1	1	0	1	0	0	0
-	0	0	0	1	1	0	0	0
-	1	0	0	1	1	0	0	0
MTL	0	1	0	1	1	0	0	0
VOL CON	1	1	0	1	1	0	0	0
VOL UP	0	0	1	1	1	0	0	0
VOL DWN	1	0	1	1	1	0	0	0
MUTE	0	1	1	1	1	0	0	0
CD	1	1	1	1	1	0	0	0

- When two keys are pressed simultaneously

Remote-controller key	Data code							
	D0	D1	D2	D3	D4	D5	D6	D7
DISP + MAN UP	1	0	1	0	1	1	0	0
DISP + MAN DWN	0	1	1	0	1	1	0	0

6.4 Example of a Remote-Controller Circuit Using the μ PD6121G-001

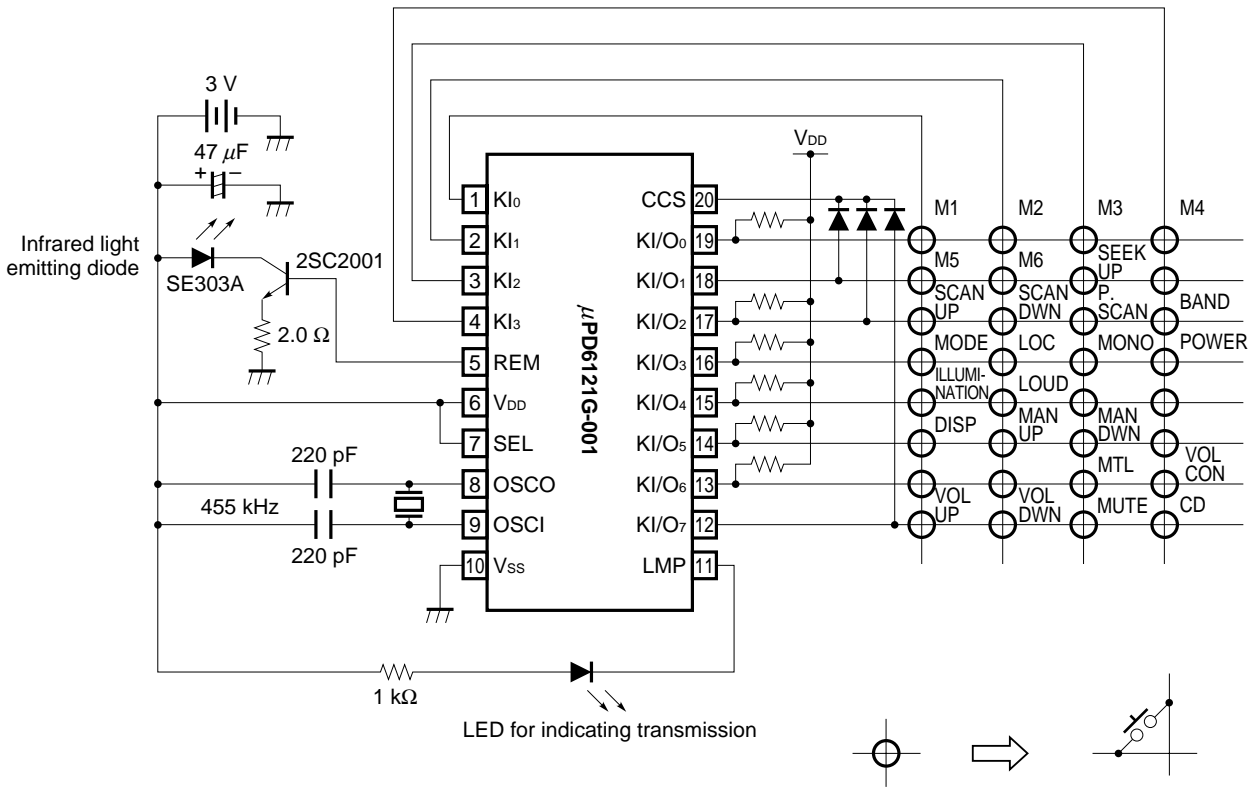

6.5 Example of a Remote-Controller Preampifier Circuit Using the μ PC2800HA

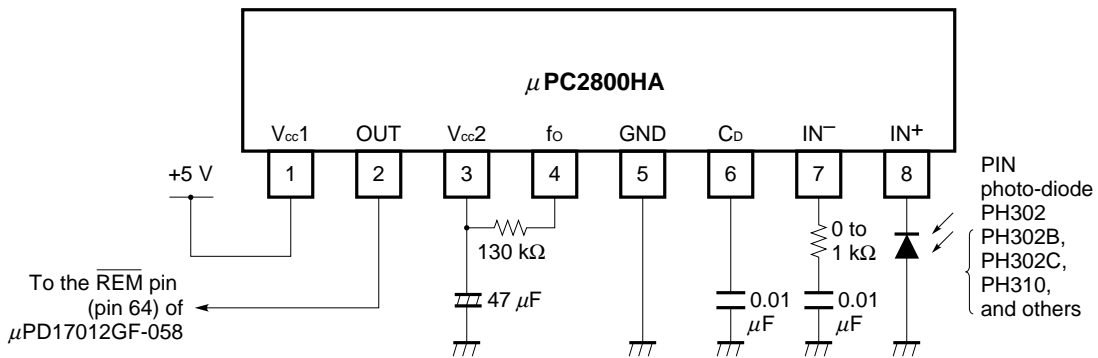

7. MUTE OUTPUT TIMING CHARTS

The numbers <1> through <6> in this chapter represent the following:

- <1>: Key-on chattering protection
- <2>: Preceding mute and beep output
- <3>: Updating of the frequency division ratio setting and indication
- <4>: Following mute
- <5>: Scan time
- <6>: Wait for PLL locking

7.1 Radio Mute ($\overline{\text{RDMUTE}}$ Pin) Output Timing Charts

(1) Manual up/down

(a) 1-channel up/down

(i) When AUTO500 switch = 0

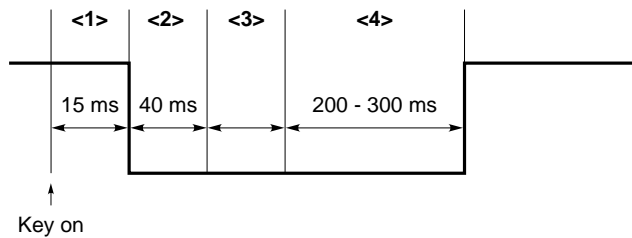

(ii) When AUTO500 switch = 1

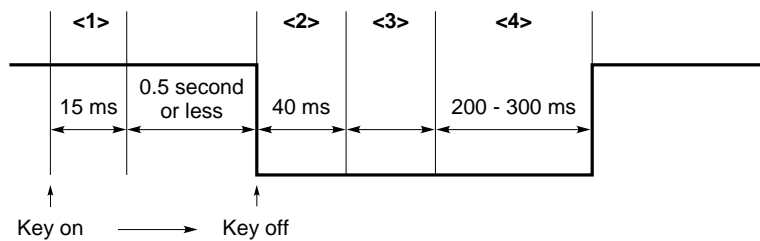

In either case (i) or case (ii), the time of <4> is 600 ms to 700 ms at the band edges (lowest frequency \rightleftharpoons highest frequency).

(b) Continuous up/down

(i) When AUTO500 switch = 0

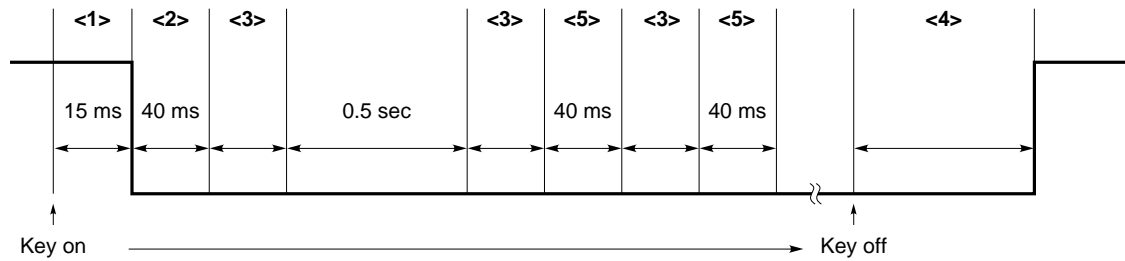

At the band edges, the time of <5> is 500 ms, and the time of <4> is 600 ms to 700 ms.

(ii) When AUTO500 switch = 1

The auto-tuning function is enabled by holding down the key for 0.5 second or more, so that continuous up/down operation is not performed.

(2) Automatic up/down

(a) SEEK UP, SCAN UP, or SCAN DWN key

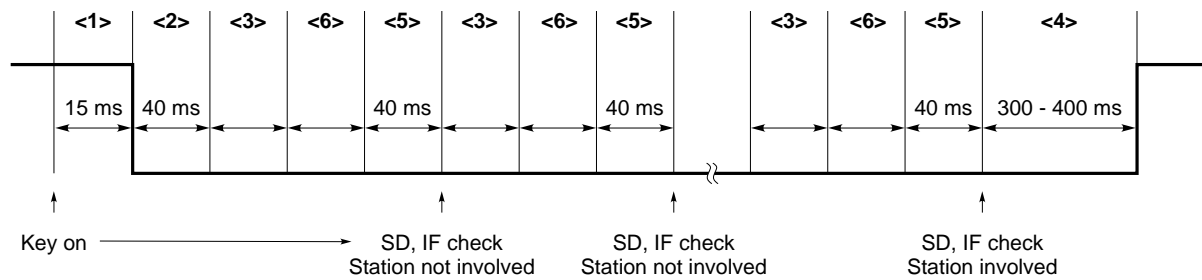

(b) When the MAN UP key is held down for 0.5 second or more when AUTO500 switch = 1

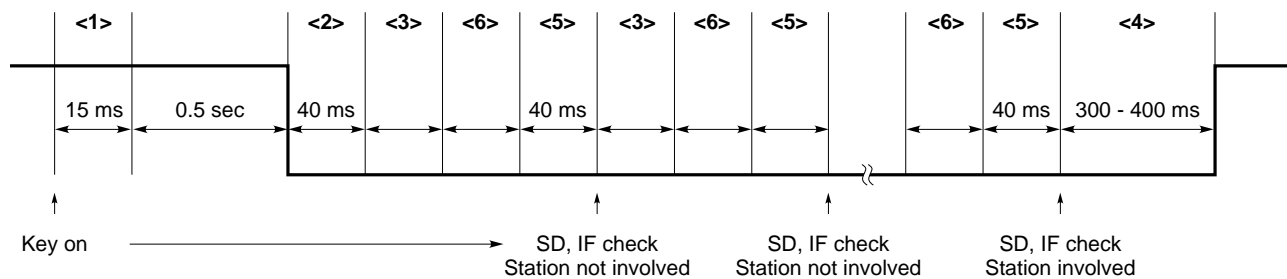

In either case (a) or case (b), the time of <5> is 540 ms at the band edges.

An IF check is made twice in the FAST mode and SLOW mode.

(3) Calling a preset memory

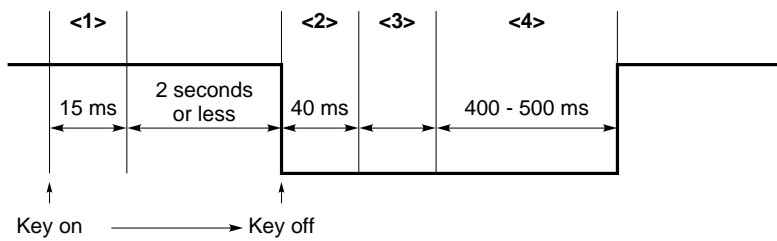

(4) Write to a preset memory

Mute output operation is not performed.

(5) Band switching

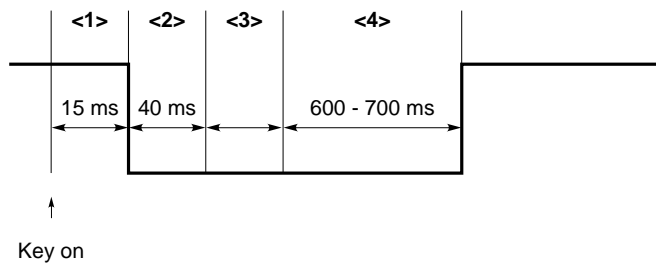

(6) Turning on or off the radio set

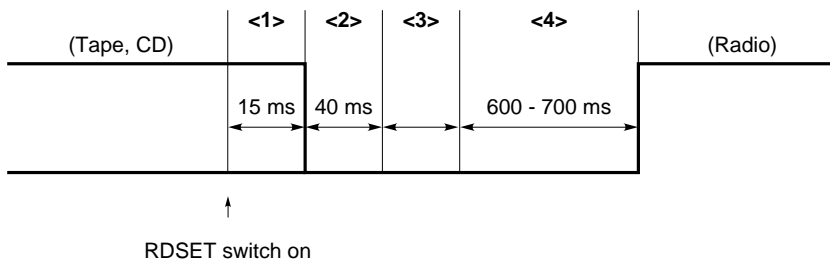

(7) Turning on or off the tape or CD

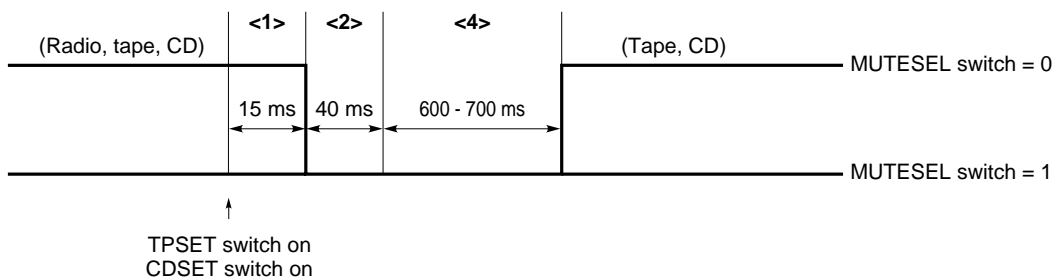

(8) Pulling the CE pin from high to low

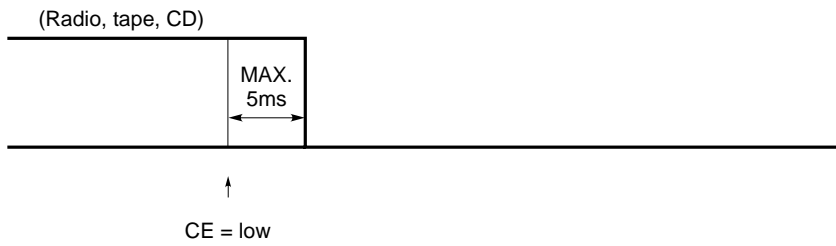

Caution When using alarm mode, always pull up the CE pin.

7.2 Radio Mute ($\overline{\text{RDMUTE}}$ Pin) and Audio Mute ($\overline{\text{AMUTE}}$ Pin) Output Timing Charts

(1) When the mode is switched from radio mode to tape or CD mode

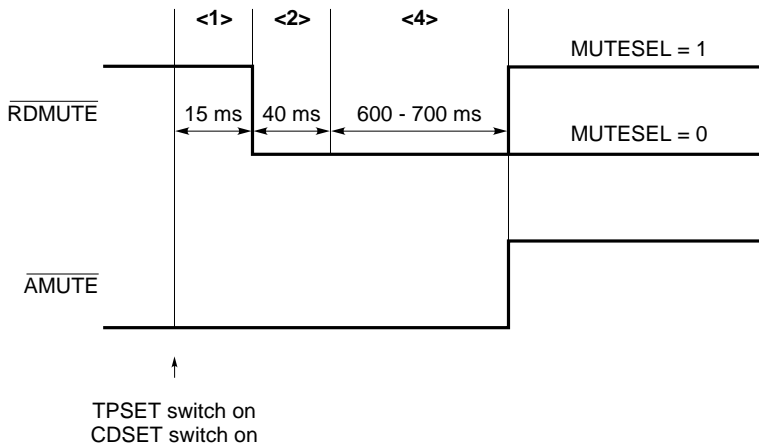

(2) When the radio monitor function is used (Set MUTESEL to 0.)

(a) Switching the radio monitor function from off to on

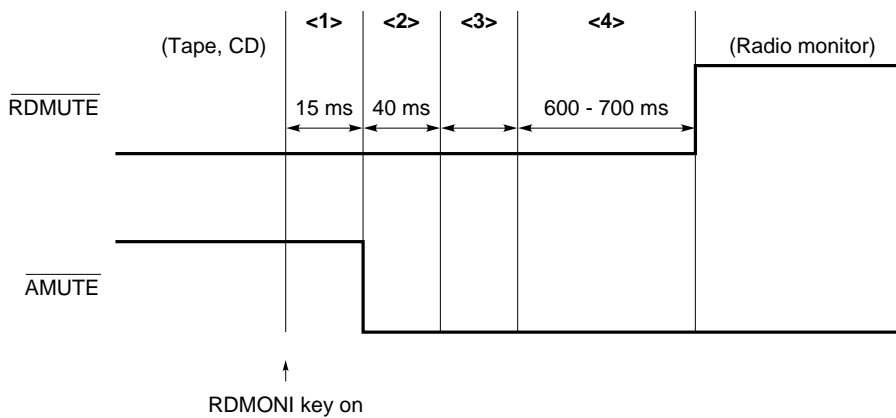

(b) Switching the radio monitor function from on to off

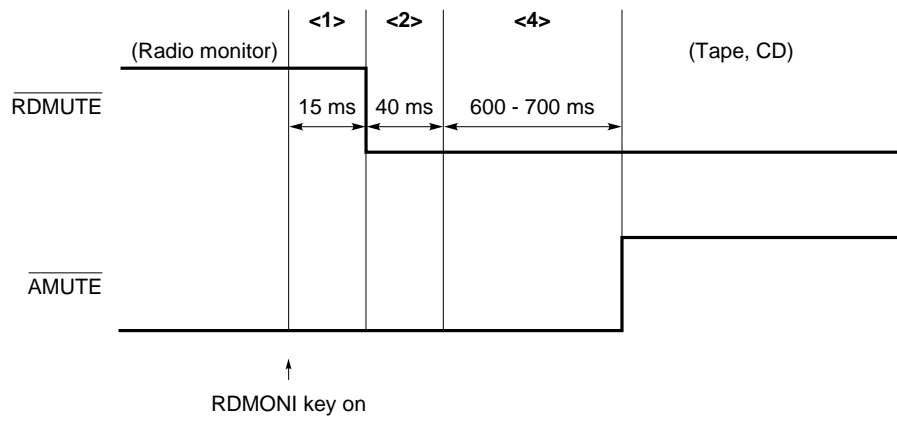

8. PIN I/O CIRCUITS

The I/O circuit of each pin of the μPD17012GF-058 is illustrated below in a simplified form.

- (1) P0A (P0A0/ALARMIN, P0A1/SO1, P0A2/ $\overline{\text{SCK}}$)
 - P0B (P0B1/BEEP, P0B0/IGNITION)
 - P1A (P1A2/MONO, P1A1/EVOL_SCK, P1A0/EVOL_DA)
 - P1D (P1D3/LOUD, P1D2/POWER, P1D1/BAND1, P1D0/BAND2)
- } (I/O)

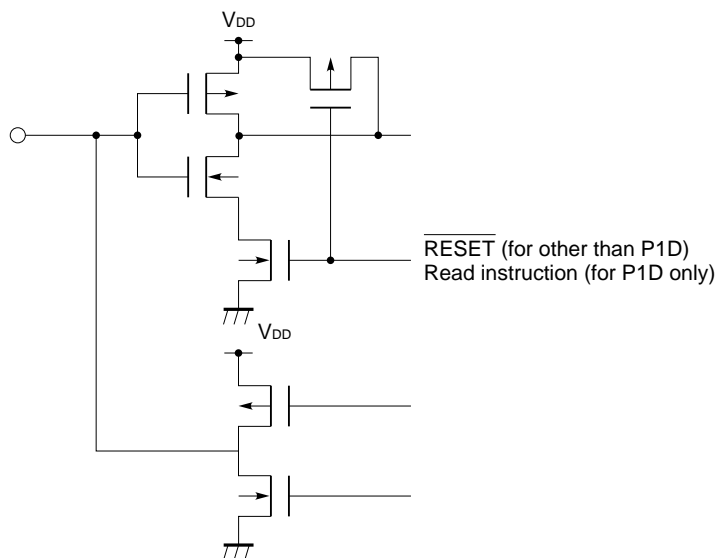

- (2) P1C (P1C3/AGCC, P1C2/LOC, P1C1/ $\overline{\text{AMUTE}}$, P1C0/ $\overline{\text{RDMUTE}}$)
 - P2H0/POUT, P2G0/ILLUMI, P2E0/ $\overline{\text{LCD CS}}$
 - PYA13/MTL, PYA12/CDOUT, PYA11/MODE2, PYA10/MODE1,
 - PYA9/KS9-PYA0/KS0
- } (Output)

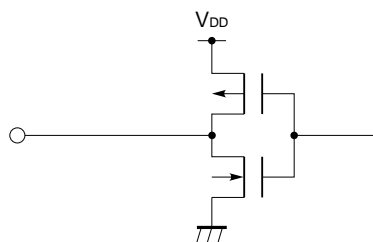

- (3) P0C (P0C3/ALARMOUT, P0C2/KEYS2 - P0C0/KEYS0) (Output)

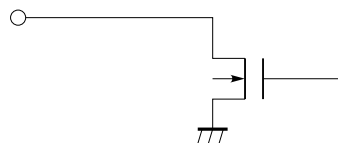

(4) P0D (P0D3/K3-P0D0/K0) (Input)

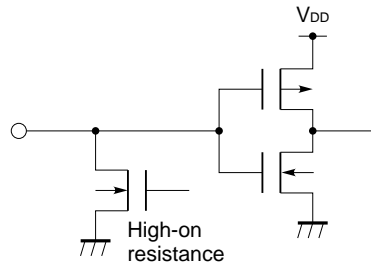

(5) P1B (P1B1/ADC1/KY-IN, P1B0/ADC0/SD) (Input)

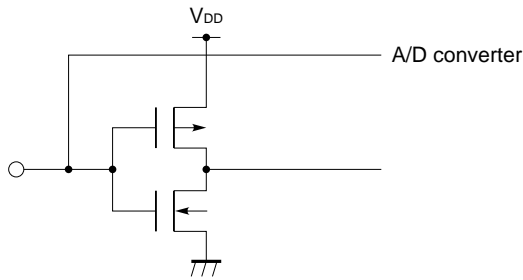

(6) P1B (P1B3/FMIFC, P1B2/AMIFC) (Input)

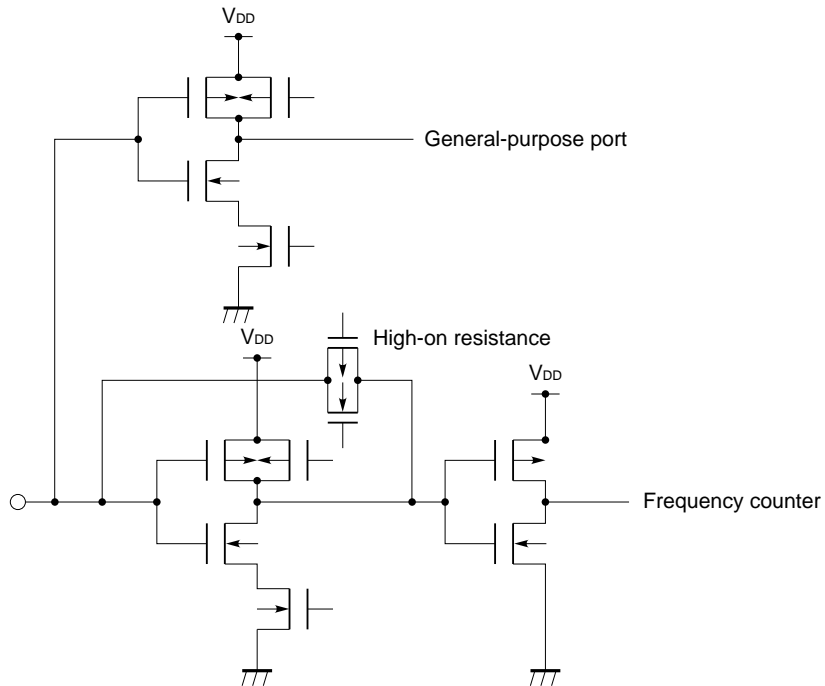

(7) CE
INT/REM } (Schmitt-triggered input)

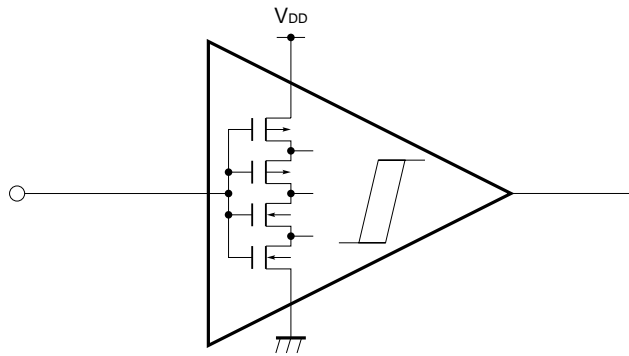

(8) X_{OUT} (Output), X_{IN} (Input)

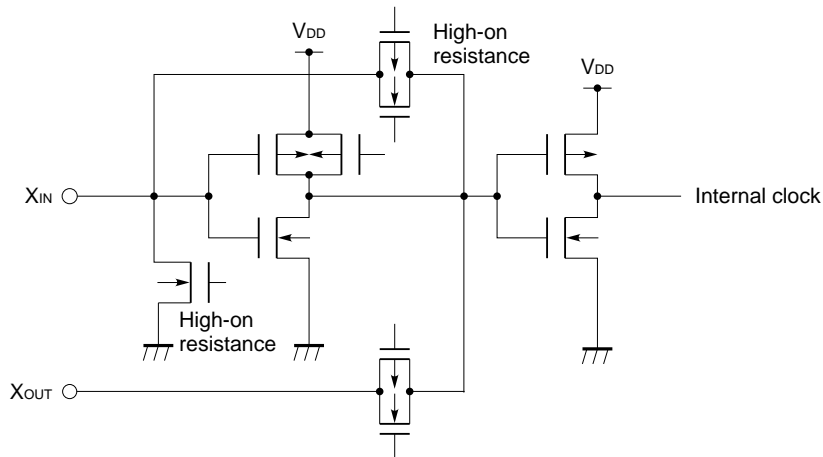

(9) EO (Output)

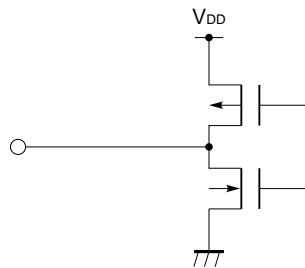

(10) VCOH } (Input)
VCOL }

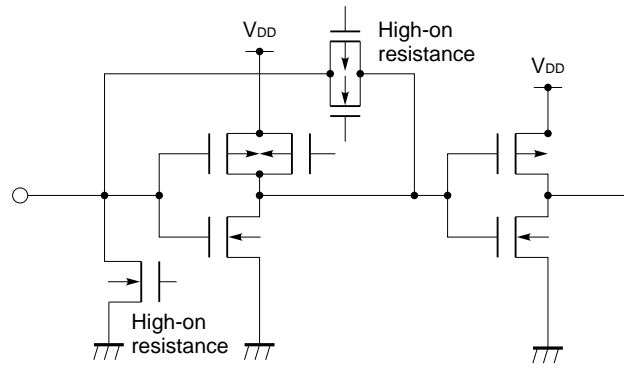

9. SAMPLE APPLICATION CIRCUITS

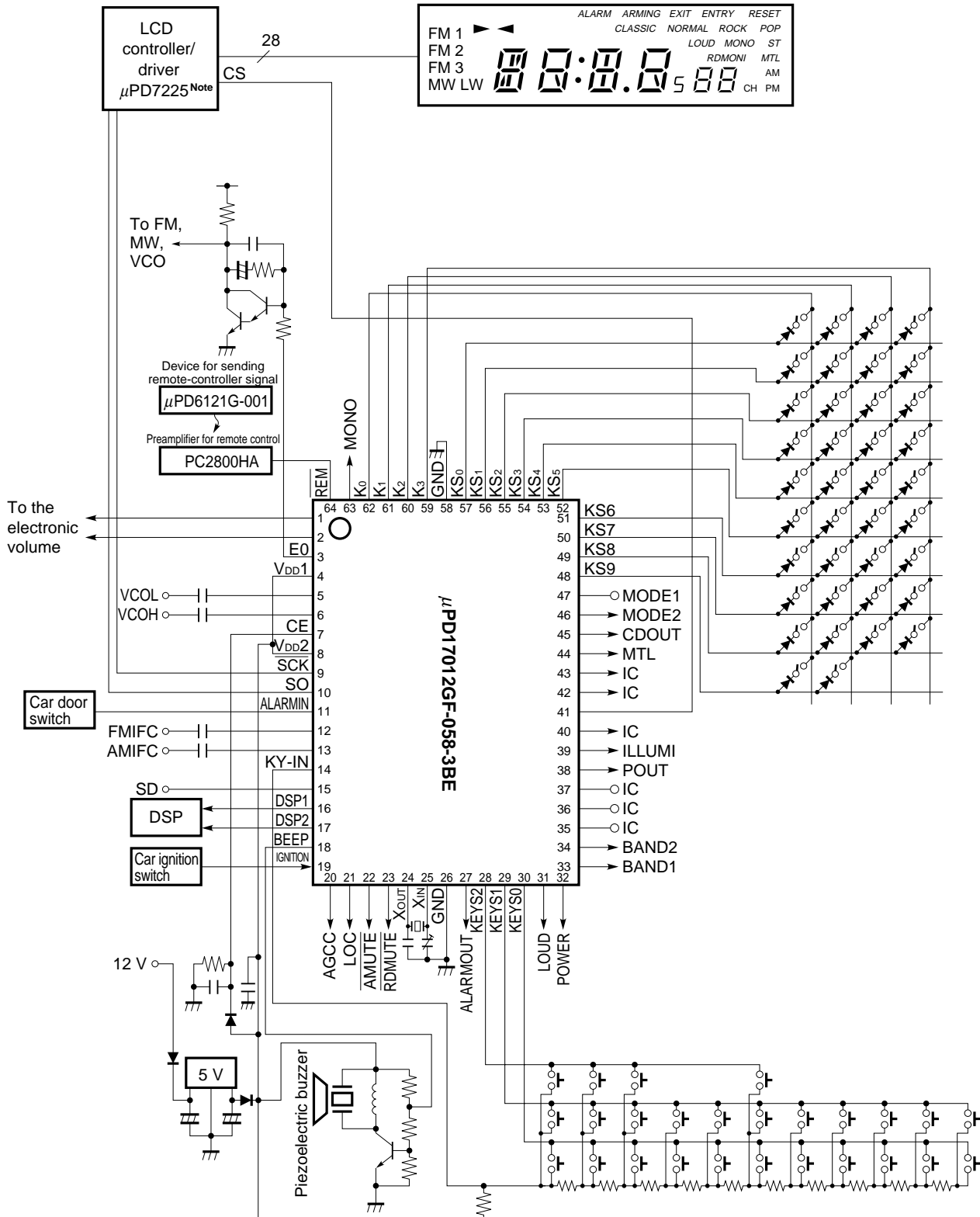

Note When the μPD7225 external LCD controller/driver is used, connect the C/D pin to the VDD pin at the μPD7225.

10. ELECTRICAL CHARACTERISTICS (PRELIMINARY)

ABSOLUTE MAXIMUM RATINGS (T_A = 25 °C)

Parameter	Symbol	Conditions	Rated value	Unit
Supply voltage	V _{DD}		-0.3 to +6.0	V
Input voltage	V _I		-0.3 to V _{DD} + 0.3	V
Output voltage	V _O	Except for P0C0 to P0C3	-0.3 to V _{DD} + 0.3	V
Output high current	I _{OH}	Each pin	-12.0	mA
		Total for all pins	-20.0	mA
Output low current	I _{OL}	Each pin	15.0	mA
		Total for all pins	30.0	mA
Output withstand voltage	V _{BDS}	P0C0 - P0C3	14.0	V
Total loss	P _t		200	mW
Operating ambient temperature	T _A		-40 to +85	°C
Storage temperature	T _{stg}		-55 to +125	°C

Caution Absolute maximum ratings are rated values beyond which physical damage will be caused to the product; if the rated value of any of the parameters in the above table is exceeded, even momentarily, the quality of the product may deteriorate. Always use the product within its rated values.

RECOMMENDED OPERATING RANGES (T_A = -40 to +85 °C)

Parameter	Symbol	Conditions	MIN.	TYP.	MAX.	Unit
Supply voltage	V _{DD1}	When the entire chip is operating	4.5	5.0	5.5	V
	V _{DD2}	When the CPU is operating, but the PLL is not	3.5	5.0	5.5	V
Data hold voltage	V _{DDR}	When the crystal oscillator is stopped	2.3		5.5	V
Output withstand voltage	V _{BDS}	P0C0 - P0C3			12.0	V
Rise time of supply voltage	t _{rise}	V _{DD} : 0 → 4.5 V			500	ms

DC CHARACTERISTICS (T_A = -40 to +85 °C, V_{DD} = 5 V ± 10 %)

Parameter	Symbol	Conditions		MIN.	TYP.	MAX.	Unit
Supply current	I _{DD1}	When the CPU is operating but the PLL is not, with a sinusoidal wave applied to the X _{IN} pin (f _{IN} = 4.5 MHz, V _{IN} = V _{DD})			1.0	2.0	mA
	I _{DD2}	When the CPU is operating but the PLL is not, with a sinusoidal wave applied to the X _{IN} pin (f _{IN} = 4.5 MHz, V _{IN} = V _{DD}) When the HALT instruction is issued			0.5	1.0	mA
Data hold voltage	V _{DDR1}	When the crystal oscillator is operating	With timer FF for interruption detection	3.5			V
	V _{DDR2}	When the crystal oscillator is stopped	With timer FF for interruption detection	2.3			V
	V _{DDR3}		For holding data memory	2.0			V
Data hold current	I _{DDR1}	When the crystal oscillator is stopped	V _{DD} = 5 V, T _A = 25 °C		2.0	4.0	μA
	I _{DDR2}				2.0	20.0	μA
	I _{DDR3}		V _{DD} = 2.3 V, T _A = 25 °C		1.0	2.0	μA
	I _{DDR4}		V _{DD} = 2.3 V		1.0	10.0	μA
Input high voltage	V _{IH1}	P0A1, P0B0 - P0B3, P1A0 - P1A2, P1B0 - P1B3, P1D0 - P1D3		0.7V _{DD}		V _{DD}	V
	V _{IH2}	P0A0, P0A2, CE, INT		0.8V _{DD}		V _{DD}	V
	V _{IH3}	P0D0 - P0D3		0.6V _{DD}		V _{DD}	V
Input low voltage	V _{IL1}	P0A1, P0B0 - P0B3, P0D0 - P0D3, P1A0 - P1A2, P1B0 - P1B3, P1D0 - P1D3				0.2V _{DD}	V
	V _{IL2}	P0A0, P0A2, CE, INT				0.2V _{DD}	V
Output high current	I _{OH1}	P0A0 - P0A2, P0B0 - P0B3, P1A0 - P1A2, P1C0 - P1C3, P1D0 - P1D3 V _{OH} = V _{DD} - 1 V		-1.0			mA
	I _{OH2}	PYA0 - PYA9, PYA11 - PYA15, P2E0, P2F0, P2G0, P2H0, EO V _{OH} = V _{DD} - 1 V		-1.0			mA
Output low current	I _{OL1}	P0A0 - P0A2, P0B0 - P0B3, P1A0 - P1A2, P1C0 - P1C3, P1D0 - P1D3 V _{OL} = 1 V		1.0			mA
	I _{OL2}	PYA0 - PYA9, PYA11 - PYA15, P2E0, P2F0, P2G0, P2H0, EO V _{OL} = 1 V		1.0			mA
	I _{OL3}	P0C0 - P0C3 V _{OL} = 1 V		10			mA
Input high current	I _{IH1}	When the VCOH pin is pulled down V _{IH} = V _{DD}		0.1			mA
	I _{IH2}	When the VCOL pin is pulled down V _{IH} = V _{DD}		0.1			mA
	I _{IH3}	When the X _{IN} pin is pulled down V _{IH} = V _{DD}		0.1			mA
	I _{IH4}	When the P0D0 to P0D3 pins are pulled down V _{IH} = V _{DD}		10		150	μA
Output-off leakage current	I _{L1}	P0C0 - P0C3 V _{OH} = 12 V				1.0	μA
	I _{L2}	EO V _{OH} = V _{DD} , V _{OL} = 0 V				±1.0	μA

AC CHARACTERISTICS (T_A = -40 to +85 °C, V_{DD} = 5 V ± 10 %)

Parameter	Symbol	Conditions	MIN.	TYP.	MAX.	Unit
Operating frequency	f _{IN1}	VCOL pin in MF mode, with a sinusoidal wave applied at V _{IN} = 0.15 V _{p-p}	0.90		30	MHz
		VCOL pin in MF mode, with a sinusoidal wave applied at V _{IN} = 0.3 V _{p-p}	0.50		20	MHz
	f _{IN2}	VCOL pin in HF mode, with a sinusoidal wave applied at V _{IN} = 0.15 V _{p-p}	5		25	MHz
		VCOL pin in HF mode, with a sinusoidal wave applied at V _{IN} = 0.3 V _{p-p}	5		40	MHz
	f _{IN3}	VCOH pin in VHF mode, with a sinusoidal wave applied at V _{IN} = 0.15 V _{p-p}	60		130	MHz
		VCOH pin in VHF mode, with a sinusoidal wave applied at V _{IN} = 0.3 V _{p-p}	30		250	MHz
	f _{IN4}	AMIFC FMIFC pin in AMIF count mode, with a sinusoidal wave applied at V _{IN} = 0.3 V _{p-p}	0.3		1.0	MHz
	f _{IN5}	AMIFC pin in AMIF count mode, with a sinusoidal wave applied at V _{IN} = 0.1 V _{p-p}	0.44		0.46	MHz
	f _{IN6}	FMIFC pin in FMIF count mode, with a sinusoidal wave applied at V _{IN} = 0.3 V _{p-p}	5		15	MHz
f _{IN7}	FMIFC pin in FMIF count mode, with a sinusoidal wave applied at V _{IN} = 0.1 V _{p-p}	10.5		10.9	MHz	

A/D CONVERTER CHARACTERISTICS (T_A = -40 to +85 °C, V_{DD} = 5 V ± 10 %)

Parameter	Symbol	Conditions	MIN.	TYP.	MAX.	Unit
Resolution of A/D conversion					6	bit
Total error in A/D conversion		T _A = -10 to +50 °C		±1.0	±1.5	LSB

OTHER CHARACTERISTICS (T_A = +25 °C, V_{DD} = 5.0 V, for reference purposes only)

Parameter	Symbol	Conditions	MIN.	TYP.	MAX.	Unit
Supply current	I _{DD3}	When the CPU and PLL are operating, with a sinusoidal wave applied to the VCOL pin (f _{IN} = 130 MHz, V _{IN} = 0.3 V _{p-p})		12		mA
	I _{DD4}	When the CPU and PLL are operating, with a sinusoidal wave applied to the VCOH pin (f _{IN} = 250 MHz, V _{IN} = 0.3 V _{p-p})		13		mA

11. PACKAGE DRAWING

64 PIN PLASTIC QFP (14×20)

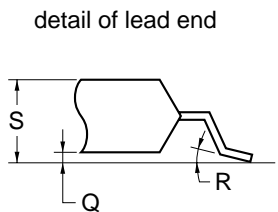
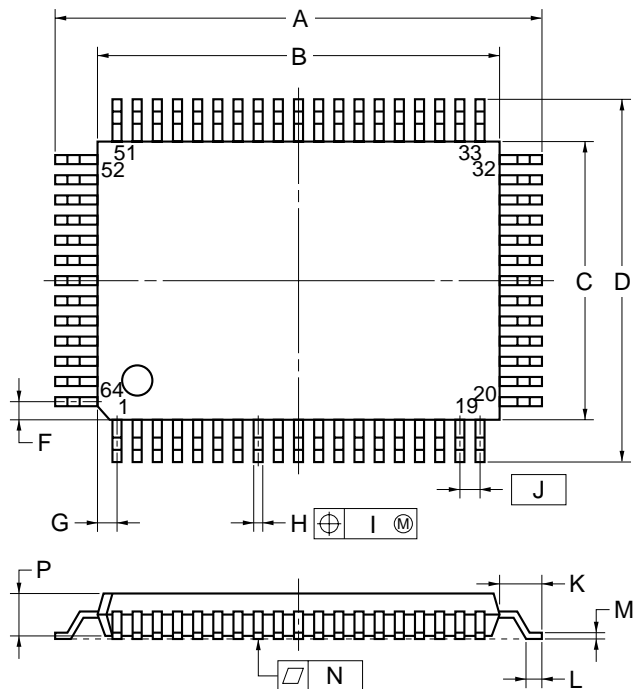

NOTE

Each lead centerline is located within 0.20 mm (0.008 inch) of its true position (T.P.) at maximum material condition.

ITEM	MILLIMETERS	INCHES
A	23.2±0.2	0.913 ^{+0.009} _{-0.008}
B	20.0±0.2	0.787 ^{+0.009} _{-0.008}
C	14.0±0.2	0.551 ^{+0.009} _{-0.008}
D	17.2±0.2	0.677±0.008
F	1.0	0.039
G	1.0	0.039
H	0.40±0.10	0.016 ^{+0.004} _{-0.005}
I	0.20	0.008
J	1.0 (T.P.)	0.039 (T.P.)
K	1.6±0.2	0.063±0.008
L	0.8±0.2	0.031 ^{+0.009} _{-0.008}
M	0.15 ^{+0.10} _{-0.05}	0.006 ^{+0.004} _{-0.003}
N	0.10	0.004
P	2.7	0.106
Q	0.125±0.075	0.005±0.003
R	5°±5°	5°±5°
S	3.0 MAX.	0.119 MAX.

S64GF-100-3B8, 3BE-3

12. RECOMMENDED SOLDERING CONDITIONS

The conditions listed below shall be met when soldering the μPD17012GF-058.

For details of the recommended soldering conditions, refer to our document *SMD Surface Mount Technology Manual* (C10535E).

Please consult with our sales offices in case any other soldering process is used, or in case soldering is done under different conditions.

Table 12-1. Soldering Conditions for Surface-Mount Devices

μPD17012GF-058-3BE: 64-pin plastic QFP (14 × 20 mm, 0.1 mm pitch)

Soldering process	Soldering conditions	Symbol
Infrared ray reflow	Peak package's surface temperature: 235 °C Reflow time: 30 seconds or less (at 210 °C or more) Maximum allowable number of reflow processes: 2 Exposure limit ^{Note} : 7 days (20 hours of pre-baking is required at 125 °C afterward.) <Cautions> Non-heat-resistant trays, such as magazine and taping trays, cannot be backed before unpacking.	IR35-207-2
VPS	Peak package's surface temperature: 215 °C Reflow time: 40 seconds or less (at 200 °C or more) Maximum allowable number of reflow processes: 2 Exposure limit ^{Note} : 7 days (20 hours of pre-baking is required at 125 °C afterward.) <Cautions> Non-heat-resistant trays, such as magazine and taping trays, cannot be backed before unpacking.	VP15-207-2
Wave soldering	Temperature in the soldering vessel: 260 °C or less Soldering time: 10 seconds or less Number of soldering processes: 1 Pre-heating temperature: 120 °C max. (package surface temperature) Exposure limit ^{Note} : 7 days (20 hours of pre-baking is required at 125 °C afterward.) <Cautions> Non-heat-resistant trays, such as magazine and taping trays, cannot be backed before unpacking.	WS60-207-1
Partial heating method	Terminal temperature: 300 °C or less Flow time: 3 seconds or less (for each side of device)	-

Note Exposure limit before soldering after dry-pack package is opened.

Storage conditions: Temperature of 25 °C and maximum relative humidity at 65 % or less

Caution Do not apply more than a single process at once, except for "Partial heating method."

APPENDIX COMMUNICATION WITH ELECTRONIC VOLUME CONTROL IC (I²C BUS INTERFACE)

The μPD17012-058 sends specified data, such as volume and balance data, to the electronic volume control IC. Two buses, the data bus and clock bus, are necessary to output data to the electronic volume control IC. Data and clock signals are output from the EVOL_DA pin (pin 2) and EVOL_SCK pin (pin 1) of the μPD17012-058.

Figure A-1. Pin Connections (Electronic Volume Control)

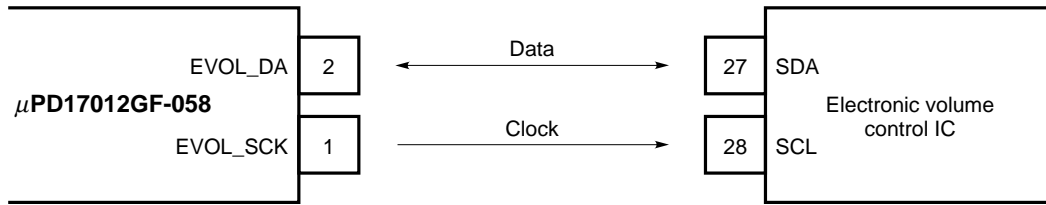

Electronic volume control data consists of nine bits (eight bits for data and a check bit). The electronic volume address (nine bits) and control data (nine bits) are sequentially transferred N times, where N is the number of transferred data items, such as the volume and balance data.

Figure A-2. Data Transfer Format (Electronic Volume Control)

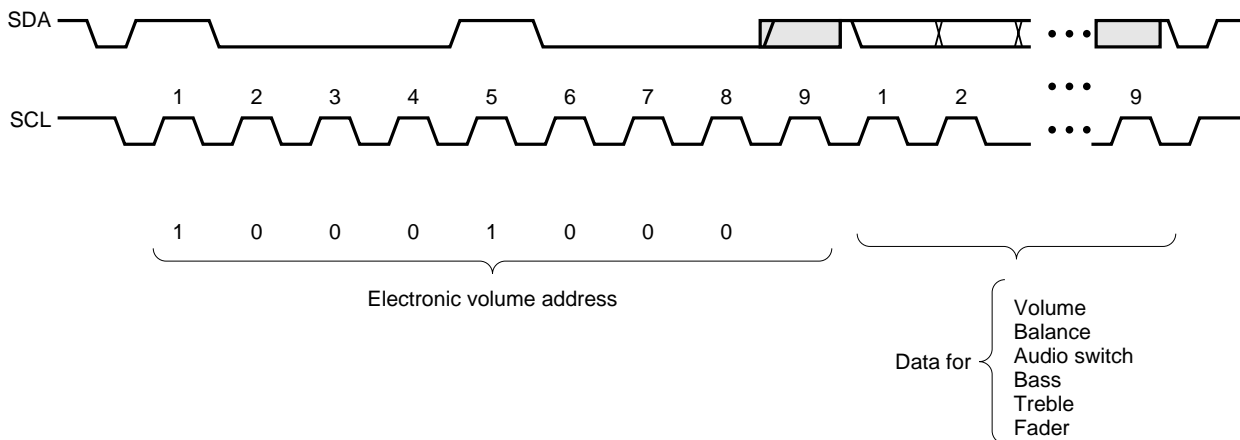

[MEMO]

NOTES FOR CMOS DEVICES

① PRECAUTION AGAINST ESD FOR SEMICONDUCTORS

Note: Strong electric field, when exposed to a MOS device, can cause destruction of the gate oxide and ultimately degrade the device operation. Steps must be taken to stop generation of static electricity as much as possible, and quickly dissipate it once, when it has occurred. Environmental control must be adequate. When it is dry, humidifier should be used. It is recommended to avoid using insulators that easily build static electricity. Semiconductor devices must be stored and transported in an anti-static container, static shielding bag or conductive material. All test and measurement tools including work bench and floor should be grounded. The operator should be grounded using wrist strap. Semiconductor devices must not be touched with bare hands. Similar precautions need to be taken for PW boards with semiconductor devices on it.

② HANDLING OF UNUSED INPUT PINS FOR CMOS

Note: No connection for CMOS device inputs can be cause of malfunction. If no connection is provided to the input pins, it is possible that an internal input level may be generated due to noise, etc., hence causing malfunction. CMOS device behave differently than Bipolar or NMOS devices. Input levels of CMOS devices must be fixed high or low by using a pull-up or pull-down circuitry. Each unused pin should be connected to V_{DD} or GND with a resistor, if it is considered to have a possibility of being an output pin. All handling related to the unused pins must be judged device by device and related specifications governing the devices.

③ STATUS BEFORE INITIALIZATION OF MOS DEVICES

Note: Power-on does not necessarily define initial status of MOS device. Production process of MOS does not define the initial operation status of the device. Immediately after the power source is turned ON, the devices with reset function have not yet been initialized. Hence, power-on does not guarantee out-pin levels, I/O settings or contents of registers. Device is not initialized until the reset signal is received. Reset operation must be executed immediately after power-on for devices having reset function.

Regional Information

Some information contained in this document may vary from country to country. Before using any NEC product in your application, please contact the NEC office in your country to obtain a list of authorized representatives and distributors. They will verify:

- Device availability
- Ordering information
- Product release schedule
- Availability of related technical literature
- Development environment specifications (for example, specifications for third-party tools and components, host computers, power plugs, AC supply voltages, and so forth)
- Network requirements

In addition, trademarks, registered trademarks, export restrictions, and other legal issues may also vary from country to country.

NEC Electronics Inc. (U.S.)

Santa Clara, California
Tel: 800-366-9782
Fax: 800-729-9288

NEC Electronics (Germany) GmbH

Duesseldorf, Germany
Tel: 0211-65 03 02
Fax: 0211-65 03 490

NEC Electronics (UK) Ltd.

Milton Keynes, UK
Tel: 01908-691-133
Fax: 01908-670-290

NEC Electronics Italiana s.r.l.

Milano, Italy
Tel: 02-66 75 41
Fax: 02-66 75 42 99

NEC Electronics (Germany) GmbH

Benelux Office
Eindhoven, The Netherlands
Tel: 040-2445845
Fax: 040-2444580

NEC Electronics (France) S.A.

Velizy-Villacoublay, France
Tel: 01-30-67 58 00
Fax: 01-30-67 58 99

NEC Electronics (France) S.A.

Spain Office
Madrid, Spain
Tel: 01-504-2787
Fax: 01-504-2860

NEC Electronics (Germany) GmbH

Scandinavia Office
Taeby, Sweden
Tel: 08-63 80 820
Fax: 08-63 80 388

NEC Electronics Hong Kong Ltd.

Hong Kong
Tel: 2886-9318
Fax: 2886-9022/9044

NEC Electronics Hong Kong Ltd.

Seoul Branch
Seoul, Korea
Tel: 02-528-0303
Fax: 02-528-4411

NEC Electronics Singapore Pte. Ltd.

United Square, Singapore 1130
Tel: 253-8311
Fax: 250-3583

NEC Electronics Taiwan Ltd.

Taipei, Taiwan
Tel: 02-719-2377
Fax: 02-719-5951

NEC do Brasil S.A.

Sao Paulo-SP, Brasil
Tel: 011-889-1680
Fax: 011-889-1689

Caution This product contains an I²C bus interface circuit.

When using the I²C bus interface, notify its use to NEC when ordering custom code. NEC can guarantee the following only when the customer informs NEC of the use of the interface:

Purchase of NEC I²C components conveys a license under the Philips I²C Patent Rights to use these components in an I²C system, provided that the system conforms to the I²C Standard Specification as defined by Philips.

The application circuits and their parameters are for reference only and are not intended for use in actual design-ins.

No part of this document may be copied or reproduced in any form or by any means without the prior written consent of NEC Corporation. NEC Corporation assumes no responsibility for any errors which may appear in this document.

NEC Corporation does not assume any liability for infringement of patents, copyrights or other intellectual property rights of third parties by or arising from use of a device described herein or any other liability arising from use of such device. No license, either express, implied or otherwise, is granted under any patents, copyrights or other intellectual property rights of NEC Corporation or others.

While NEC Corporation has been making continuous effort to enhance the reliability of its semiconductor devices, the possibility of defects cannot be eliminated entirely. To minimize risks of damage or injury to persons or property arising from a defect in an NEC semiconductor device, customers must incorporate sufficient safety measures in its design, such as redundancy, fire-containment, and anti-failure features.

NEC devices are classified into the following three quality grades:

"Standard", "Special", and "Specific". The Specific quality grade applies only to devices developed based on a customer designated "quality assurance program" for a specific application. The recommended applications of a device depend on its quality grade, as indicated below. Customers must check the quality grade of each device before using it in a particular application.

Standard: Computers, office equipment, communications equipment, test and measurement equipment, audio and visual equipment, home electronic appliances, machine tools, personal electronic equipment and industrial robots

Special: Transportation equipment (automobiles, trains, ships, etc.), traffic control systems, anti-disaster systems, anti-crime systems, safety equipment and medical equipment (not specifically designed for life support)

Specific: Aircrafts, aerospace equipment, submersible repeaters, nuclear reactor control systems, life support systems or medical equipment for life support, etc.

The quality grade of NEC devices is "Standard" unless otherwise specified in NEC's Data Sheets or Data Books. If customers intend to use NEC devices for applications other than those specified for Standard quality grade, they should contact an NEC sales representative in advance.

Anti-radioactive design is not implemented in this product.