

384-OUTPUT TFT-LCD SOURCE DRIVER (COMPATIBLE WITH 64-GRAY SCALES)

- ★ The μ PD16732 is a source driver for TFT-LCDs capable of dealing with displays with 64-gray scales. Data input is based on digital input configured as 6 bits by 6 dots (2 pixels), which can realize a full-color display of 260,000 colors by output of 64 values γ -corrected by an internal D/A converter and 5-by-2 external power modules. Because the output dynamic range is as large as $V_{SS2}+0.1$ V to $V_{DD2}-0.1$ V, level inversion operation of the LCD's common electrode is rendered unnecessary. Also, to be able to deal with dot-line inversion, n-line inversion and column line inversion when mounted on a single side, this source driver is equipped with a built-in 6-bit D/A converter circuit whose odd output pins and even output pins respectively output gray scale voltages of differing polarity. Assuring a maximum clock frequency of 40 MHz when driving at 3.0 V, this driver is applicable to XGA-standard TFT-LCD panels and SXGA TFT-LCD panels by input display signal 2 systems (Clock divide).

FEATURES

- 384 Outputs
- Capable of outputting 64 values by means of 5-by-2 external power modules (10 units) and a D/A converter
- ★ • Output dynamic range : $V_{SS2}+0.1$ V to $V_{DD2}-0.1$ V
- ★ • Logic part power supply voltage (V_{DD1}) : 3.3 ± 0.3 V
- ★ • Driver part power supply voltage (V_{DD2}) : 8.5 ± 0.5 V
- CMOS level input
- Input of 6 bits (gradation data) by 6 dots
- High-speed data transfer: $f_{MAX.} = 40$ MHz (internal data transfer speed when operating at 3.0 V)
- Apply for dot-line inversion, n-line inversion and column line inversion
- Single bank arrangement is possible (loaded with slim or bending TCP) (POL)
- Display data inversion function (POL2)

ORDERING INFORMATION

Part Number	Package
μ PD16732N-xxx	TCP (TAB package)

Remark The TCP's external shape is customized. To order your TCP's external shape, please contact a NEC salesperson.

The information in this document is subject to change without notice. Before using this document, please confirm that this is the latest version.
Not all devices/types available in every country. Please check with local NEC representative for availability and additional information.

BLOCK DIAGRAM

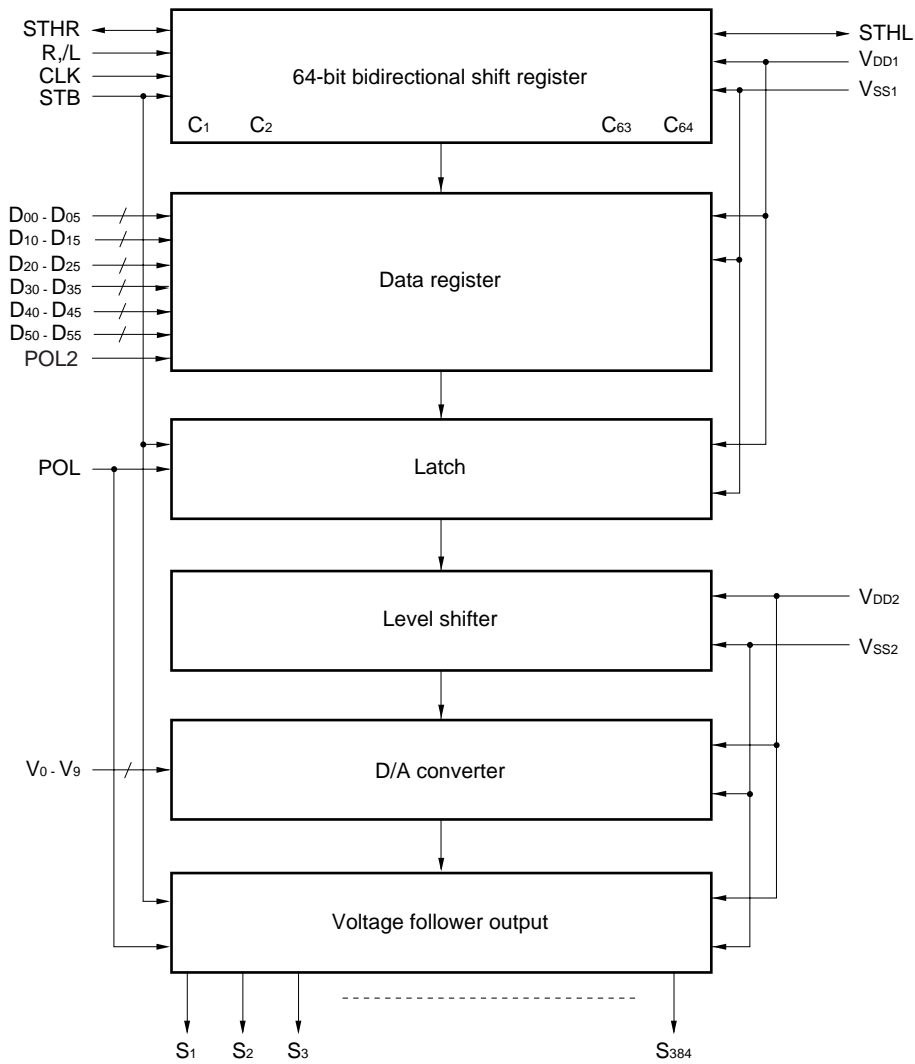

Remark /xxx indicates active low signal.

RELATIONSHIP BETWEEN OUTPUT CIRCUIT AND D/A CONVERTER

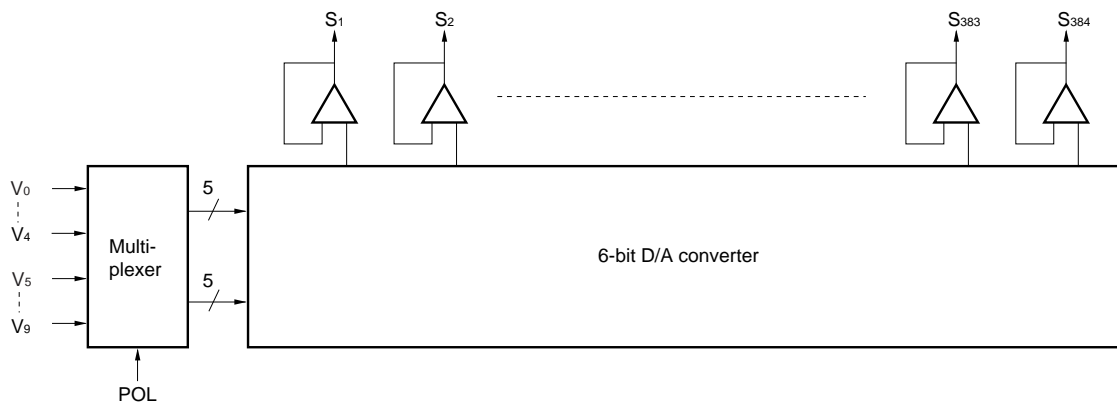

PIN CONFIGURATION (μ PD16732N-xxx)

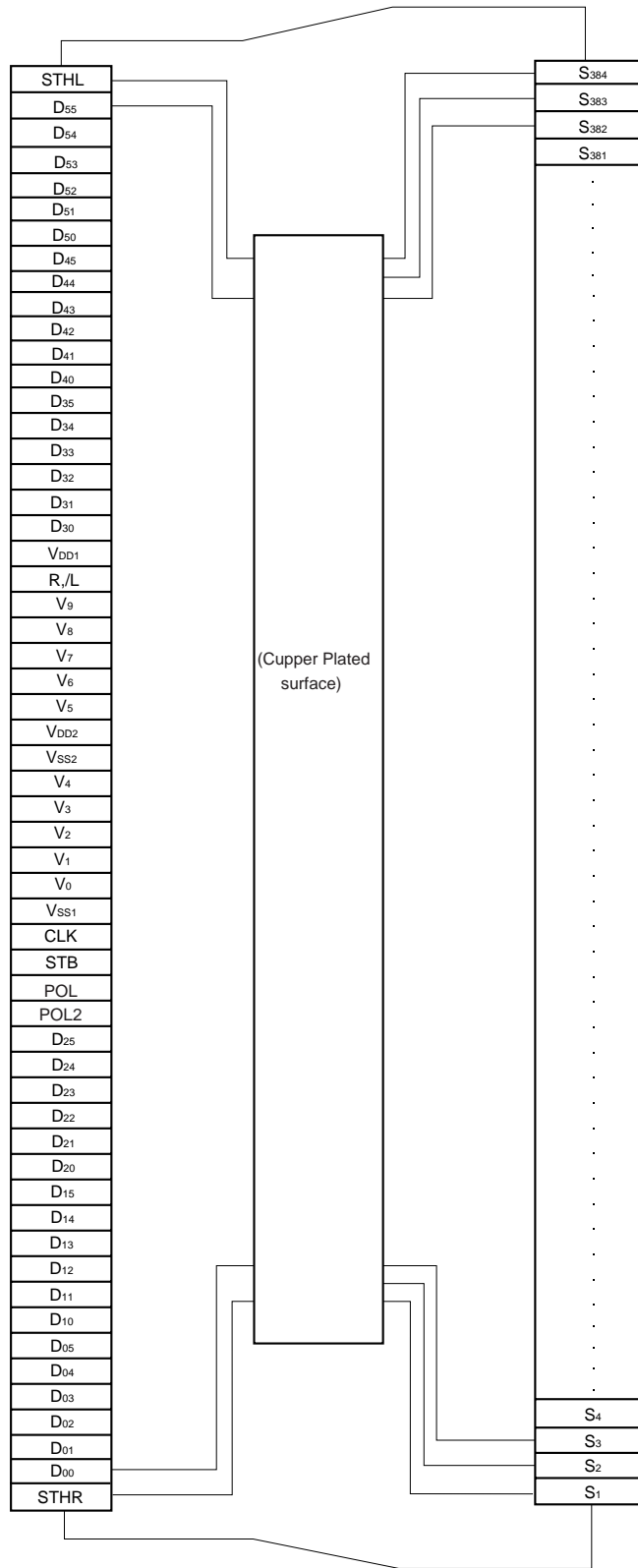

Remark This figure does not specify the TCP package.

1. PIN FUNCTIONS

Pin Symbol	Pin Name	Description
S ₁ to S ₃₈₄	Driver output	The D/A converted 64-gray-scale analog voltage is output.
D ₀₀ to D ₀₅	Display data input	The display data is input with a width of 36 bits, viz., the gray scale data (6 bits) by 6 dots (2 pixels). D _{X0} : LSB, D _{X5} : MSB
D ₁₀ to D ₁₅		
D ₂₀ to D ₂₅		
D ₃₀ to D ₃₅		
D ₄₀ to D ₄₅		
D ₅₀ to D ₅₅		
R, _/ L	Shift direction control input	These refer to the start pulse input/output pins when driver ICs are connected in cascade. The shift directions of the shift registers are as follows. R, _/ L = H : STHR input, S ₁ → S ₃₈₄ , STHL output R, _/ L = L : STHL input, S ₃₈₄ → S ₁ , STHR output
STHR	Right shift start pulse input/output	R, _/ L = H : Becomes the start pulse input pin. R, _/ L = L : Becomes the start pulse output pin.
STHL	Left shift start pulse input/output	R, _/ L = H : Becomes the start pulse output pin. R, _/ L = L : Becomes the start pulse input pin.
CLK	Shift clock input	Refers to the shift register's shift clock input. The display data is incorporated into the data register at the rising edge. At the rising edge of the 64th clock after the start pulse input, the start pulse output reaches the high level, thus becoming the start pulse of the next-level driver.
STB	Latch input	The contents of the data register are transferred to the latch circuit at the rising edge. And, at the falling edge, the gray scale voltage is supplied to the driver. It is necessary to ensure input of one pulse per horizontal period.
POL	Polarity input	POL = L : The S _{2n-1} output uses V ₀ to V ₄ as the reference supply. The S _{2n} output uses V ₅ to V ₉ as the reference supply. POL = H : The S _{2n-1} output uses V ₅ to V ₉ as the reference supply. The S _{2n} output uses V ₀ to V ₄ as the reference supply. S _{2n-1} indicates the odd output: and S _{2n} indicates the even output. Input of the POL signal is allowed the setup time(t _{POL-STB}) with respect to STB's rising edge.
POL2	Data inversion	POL2 = H : Display data is inverted. POL2 = L : Display data is not inverted.
V ₀ to V ₉	γ-corrected power supplies	Input the γ-corrected power supplies from outside by using operational amplifier. Make sure to maintain the following relationships. During the gray scale voltage output, be sure to keep the gray scale level power supply at a constant level. V _{DD2} > V ₀ > V ₁ > V ₂ > V ₃ > V ₄ > V ₅ > V ₆ > V ₇ > V ₈ > V ₉ > V _{SS2}
V _{DD1}	Logic power supply	3.3 V ± 0.3 V
★ V _{DD2}	Driver power supply	8.5 V ± 0.5 V
V _{SS1}	Logic ground	Grounding
V _{SS2}	Driver ground	Grounding

- Cautions 1. The power start sequence must be V_{DD1}, logic input, and V_{DD2} & V₀ to V₉ in that order. Reverse this sequence to shut down. (Simultaneous power application to V_{DD2} and V₀ to V₉ is possible.)**
- 2. To stabilize the supply voltage, please be sure to insert a 0.1 μF bypass capacitor between V_{DD1}-V_{SS1} and V_{DD2}-V_{SS2}. Furthermore, for increased precision of the D/A converter, insertion of a bypass capacitor of about 0.01 μF is also advised between the γ-corrected power supply terminals (V₀, V₁, V₂, ..., V₉) and V_{SS2}.**

2. RELATIONSHIP BETWEEN INPUT DATA AND OUTPUT VOLTAGE VALUE

This product incorporates a 6-bit D/A converter whose odd output pins and even output pins output respectively gray scale voltages of differing polarity with respect to the LCD's counter electrode (common electrode) voltage. The D/A converter consists of ladder resistors and switches.

Figure 2-1 shows the relationship between the driving voltages such as liquid-crystal driving voltages V_{DD2} and V_{SS2} , common electrode potential V_{COM} , and γ -corrected voltages V_0 to V_9 and the input data. Be sure to maintain the voltage relationships of $V_{DD2} > V_0 > V_1 > V_2 > V_3 > V_4 > V_5 > V_6 > V_7 > V_8 > V_9 > V_{SS2}$.

Figures 2-2 and 2-3 show the relationship between the input data and the output data. This driver IC is designed for only single-sided mounting. Therefore, please do not use it for γ -corrected power supply level inversion in double-sided mounting.

Figure 2-1. Relationship between Input Data and γ -corrected Power Supply

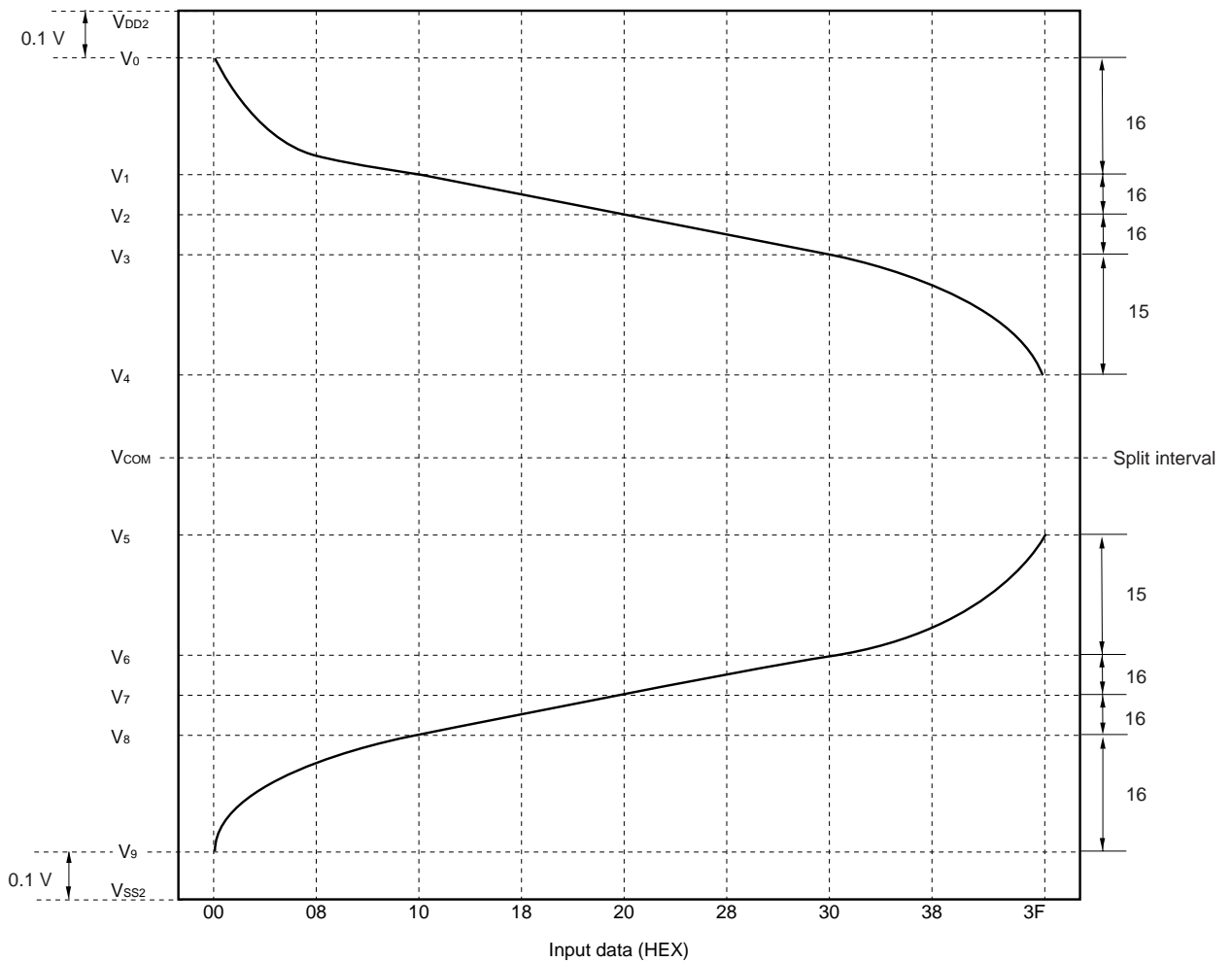
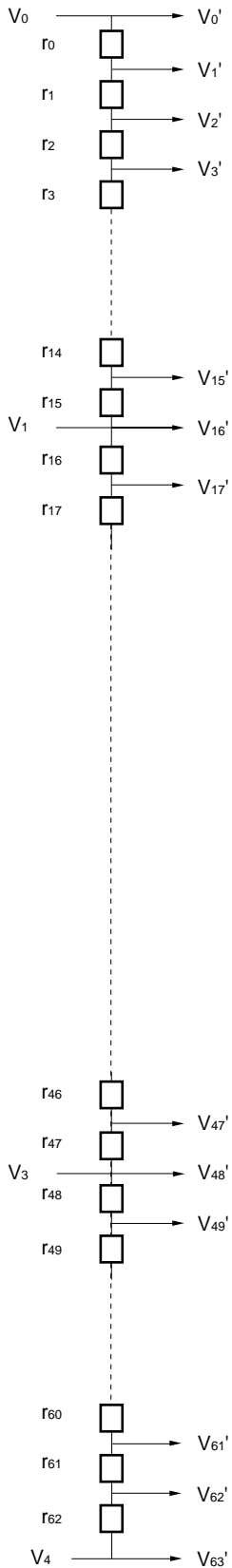

Figure 2-2. Relationship between Input Data and Output Voltage(1/2)

$$V_{DD2} > V_0 > V_1 > V_2 > V_3 > V_4 > V_5, \text{POL2} = L$$



Data	Dx5	Dx4	Dx3	Dx2	Dx1	Dx0	Output Voltage	
00H	0	0	0	0	0	0	V _{0'}	V ₀
01H	0	0	0	0	0	1	V _{1'}	V ₁ +(V ₀ -V ₁)×7250/8050
02H	0	0	0	0	1	0	V _{2'}	V ₁ +(V ₀ -V ₁)×6500/8050
03H	0	0	0	0	1	1	V _{3'}	V ₁ +(V ₀ -V ₁)×5800/8050
04H	0	0	0	1	0	0	V _{4'}	V ₁ +(V ₀ -V ₁)×5150/8050
05H	0	0	0	1	0	1	V _{5'}	V ₁ +(V ₀ -V ₁)×4550/8050
06H	0	0	0	1	1	0	V _{6'}	V ₁ +(V ₀ -V ₁)×4000/8050
07H	0	0	0	1	1	1	V _{7'}	V ₁ +(V ₀ -V ₁)×3450/8050
08H	0	0	1	0	0	0	V _{8'}	V ₁ +(V ₀ -V ₁)×2950/8050
09H	0	0	1	0	0	1	V _{9'}	V ₁ +(V ₀ -V ₁)×2450/8050
0AH	0	0	1	0	1	0	V _{10'}	V ₁ +(V ₀ -V ₁)×2050/8050
0BH	0	0	1	0	1	1	V _{11'}	V ₁ +(V ₀ -V ₁)×1650/8050
0CH	0	0	1	1	0	0	V _{12'}	V ₁ +(V ₀ -V ₁)×1300/8050
0DH	0	0	1	1	0	1	V _{13'}	V ₁ +(V ₀ -V ₁)× 950/8050
0EH	0	0	1	1	1	0	V _{14'}	V ₁ +(V ₀ -V ₁)× 600/8050
0FH	0	0	1	1	1	1	V _{15'}	V ₁ +(V ₀ -V ₁)× 300/8050
10H	0	1	0	0	0	0	V _{16'}	V ₁
11H	0	1	0	0	0	1	V _{17'}	V ₂ +(V ₁ -V ₂)×2450/2750
12H	0	1	0	0	1	0	V _{18'}	V ₂ +(V ₁ -V ₂)×2200/2750
13H	0	1	0	0	1	1	V _{19'}	V ₂ +(V ₁ -V ₂)×1950/2750
14H	0	1	0	1	0	0	V _{20'}	V ₂ +(V ₁ -V ₂)×1700/2750
15H	0	1	0	1	0	1	V _{21'}	V ₂ +(V ₁ -V ₂)×1500/2750
16H	0	1	0	1	1	0	V _{22'}	V ₂ +(V ₁ -V ₂)×1300/2750
17H	0	1	0	1	1	1	V _{23'}	V ₂ +(V ₁ -V ₂)×1100/2750
18H	0	1	1	0	0	0	V _{24'}	V ₂ +(V ₁ -V ₂)× 950/2750
19H	0	1	1	0	0	1	V _{25'}	V ₂ +(V ₁ -V ₂)× 800/2750
1AH	0	1	1	0	1	0	V _{26'}	V ₂ +(V ₁ -V ₂)× 650/2750
1BH	0	1	1	0	1	1	V _{27'}	V ₂ +(V ₁ -V ₂)× 500/2750
1CH	0	1	1	1	0	0	V _{28'}	V ₂ +(V ₁ -V ₂)× 400/2750
1DH	0	1	1	1	0	1	V _{29'}	V ₂ +(V ₁ -V ₂)× 300/2750
1EH	0	1	1	1	1	0	V _{30'}	V ₂ +(V ₁ -V ₂)× 200/2750
1FH	0	1	1	1	1	1	V _{31'}	V ₂ +(V ₁ -V ₂)× 100/2750
20H	1	0	0	0	0	0	V _{32'}	V ₂
21H	1	0	0	0	0	1	V _{33'}	V ₃ +(V ₂ -V ₃)×1500/1600
22H	1	0	0	0	1	0	V _{34'}	V ₃ +(V ₂ -V ₃)×1400/1600
23H	1	0	0	0	1	1	V _{35'}	V ₃ +(V ₂ -V ₃)×1300/1600
24H	1	0	0	1	0	0	V _{36'}	V ₃ +(V ₂ -V ₃)×1200/1600
25H	1	0	0	1	0	1	V _{37'}	V ₃ +(V ₂ -V ₃)×1100/1600
26H	1	0	0	1	1	0	V _{38'}	V ₃ +(V ₂ -V ₃)×1000/1600
27H	1	0	0	1	1	1	V _{39'}	V ₃ +(V ₂ -V ₃)× 900/1600
28H	1	0	1	0	0	0	V _{40'}	V ₃ +(V ₂ -V ₃)× 800/1600
29H	1	0	1	0	0	1	V _{41'}	V ₃ +(V ₂ -V ₃)× 700/1600
2AH	1	0	1	0	1	0	V _{42'}	V ₃ +(V ₂ -V ₃)× 600/1600
2BH	1	0	1	0	1	1	V _{43'}	V ₃ +(V ₂ -V ₃)× 500/1600
2CH	1	0	1	1	0	0	V _{44'}	V ₃ +(V ₂ -V ₃)× 400/1600
2DH	1	0	1	1	0	1	V _{45'}	V ₃ +(V ₂ -V ₃)× 300/1600
2EH	1	0	1	1	1	0	V _{46'}	V ₃ +(V ₂ -V ₃)× 200/1600
2FH	1	0	1	1	1	1	V _{47'}	V ₃ +(V ₂ -V ₃)× 100/1600
30H	1	1	0	0	0	0	V _{48'}	V ₃
31H	1	1	0	0	0	1	V _{49'}	V ₄ +(V ₃ -V ₄)×3350/3450
32H	1	1	0	0	1	0	V _{50'}	V ₄ +(V ₃ -V ₄)×3250/3450
33H	1	1	0	0	1	1	V _{51'}	V ₄ +(V ₃ -V ₄)×3150/3450
34H	1	1	0	1	0	0	V _{52'}	V ₄ +(V ₃ -V ₄)×3050/3450
35H	1	1	0	1	0	1	V _{53'}	V ₄ +(V ₃ -V ₄)×2950/3450
36H	1	1	0	1	1	0	V _{54'}	V ₄ +(V ₃ -V ₄)×2800/3450
37H	1	1	0	1	1	1	V _{55'}	V ₄ +(V ₃ -V ₄)×2650/3450
38H	1	1	1	0	0	0	V _{56'}	V ₄ +(V ₃ -V ₄)×2500/3450
39H	1	1	1	0	0	1	V _{57'}	V ₄ +(V ₃ -V ₄)×2300/3450
3AH	1	1	1	0	1	0	V _{58'}	V ₄ +(V ₃ -V ₄)×2100/3450
3BH	1	1	1	0	1	1	V _{59'}	V ₄ +(V ₃ -V ₄)×1850/3450
3CH	1	1	1	1	0	0	V _{60'}	V ₄ +(V ₃ -V ₄)×1600/3450
3DH	1	1	1	1	0	1	V _{61'}	V ₄ +(V ₃ -V ₄)×1300/3450
3EH	1	1	1	1	1	0	V _{62'}	V ₄ +(V ₃ -V ₄)× 800/3450
3FH	1	1	1	1	1	1	V _{63'}	V ₄

m	(Ω)
r ₀	800
r ₁	750
r ₂	700
r ₃	650
r ₄	600
r ₅	550
r ₆	550
r ₇	500
r ₈	500
r ₉	400
r ₁₀	400
r ₁₁	350
r ₁₂	350
r ₁₃	350
r ₁₄	300
r ₁₅	300
r ₁₆	300
r ₁₇	250
r ₁₈	250
r ₁₉	250
r ₂₀	200
r ₂₁	200
r ₂₂	200
r ₂₃	150
r ₂₄	150
r ₂₅	150
r ₂₆	150
r ₂₇	100
r ₂₈	100
r ₂₉	100
r ₃₀	100
r ₃₁	100
r ₃₂	100
r ₃₃	100
r ₃₄	100
r ₃₅	100
r ₃₆	100
r ₃₇	100
r ₃₈	100
r ₃₉	100
r ₄₀	100
r ₄₁	100
r ₄₂	100
r ₄₃	100
r ₄₄	100
r ₄₅	100
r ₄₆	100
r ₄₇	100
r ₄₈	100
r ₄₉	100
r ₅₀	100
r ₅₁	100
r ₅₂	100
r ₅₃	150
r ₅₄	150
r ₅₅	150
r ₅₆	200
r ₅₇	200
r ₅₈	250
r ₅₉	250
r ₆₀	300
r ₆₁	500
r ₆₂	800
r _{total}	15850

Caution Between V₄ and V₅ terminal is not connected in the chip.

Figure 2-3. Relationship between Input Data and Output Voltage(2/2)

$$V_4 > V_5 > V_6 > V_7 > V_8 > V_9 > V_{SS2}, POL2 = L$$

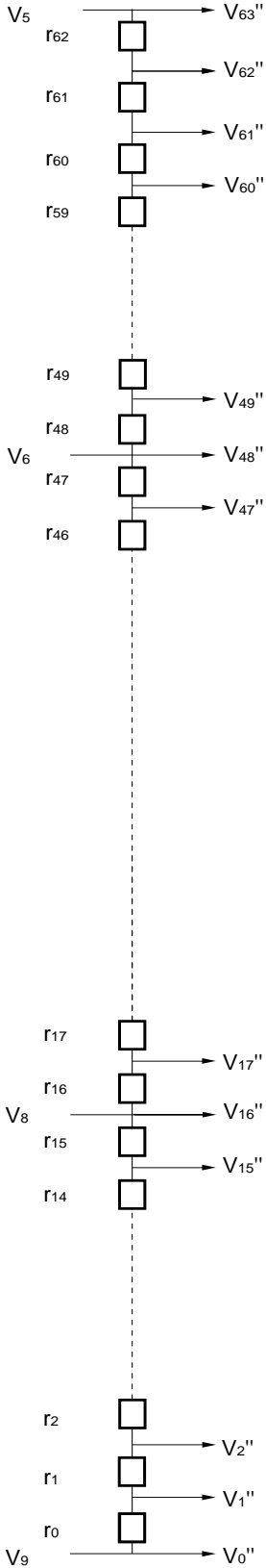

Data	Dx5	Dx4	Dx3	Dx2	Dx1	Dx0	Output Voltage	
3F _H	1	1	1	1	1	1	V ₆₃ ''	V ₅
3E _H	1	1	1	1	1	0	V ₆₂ ''	$V_6+(V_5-V_6) \times 2650/3450$
3D _H	1	1	1	1	0	1	V ₆₁ ''	$V_6+(V_5-V_6) \times 2150/3450$
3C _H	1	1	1	1	0	0	V ₆₀ ''	$V_6+(V_5-V_6) \times 1850/3450$
3B _H	1	1	1	0	1	1	V ₅₉ ''	$V_6+(V_5-V_6) \times 1600/3450$
3A _H	1	1	1	0	1	0	V ₅₈ ''	$V_6+(V_5-V_6) \times 1350/3450$
39 _H	1	1	1	0	0	1	V ₅₇ ''	$V_6+(V_5-V_6) \times 1150/3450$
38 _H	1	1	1	0	0	0	V ₅₆ ''	$V_6+(V_5-V_6) \times 950/3450$
37 _H	1	1	0	1	1	1	V ₅₅ ''	$V_6+(V_5-V_6) \times 800/3450$
36 _H	1	1	0	1	1	0	V ₅₄ ''	$V_6+(V_5-V_6) \times 650/3450$
35 _H	1	1	0	1	0	1	V ₅₃ ''	$V_6+(V_5-V_6) \times 500/3450$
34 _H	1	1	0	1	0	0	V ₅₂ ''	$V_6+(V_5-V_6) \times 400/3450$
33 _H	1	1	0	0	1	1	V ₅₁ ''	$V_6+(V_5-V_6) \times 300/3450$
32 _H	1	1	0	0	1	0	V ₅₀ ''	$V_6+(V_5-V_6) \times 200/3450$
31 _H	1	1	0	0	0	1	V ₄₉ ''	$V_6+(V_5-V_6) \times 100/3450$
30 _H	1	1	0	0	0	0	V ₄₈ ''	V ₆
2F _H	1	0	1	1	1	1	V ₄₇ ''	$V_7+(V_6-V_7) \times 1500/1600$
2E _H	1	0	1	1	1	0	V ₄₆ ''	$V_7+(V_6-V_7) \times 1400/1600$
2D _H	1	0	1	1	0	1	V ₄₅ ''	$V_7+(V_6-V_7) \times 1300/1600$
2C _H	1	0	1	1	0	0	V ₄₄ ''	$V_7+(V_6-V_7) \times 1200/1600$
2B _H	1	0	1	0	1	1	V ₄₃ ''	$V_7+(V_6-V_7) \times 1100/1600$
2A _H	1	0	1	0	1	0	V ₄₂ ''	$V_7+(V_6-V_7) \times 1000/1600$
29 _H	1	0	1	0	0	1	V ₄₁ ''	$V_7+(V_6-V_7) \times 900/1600$
28 _H	1	0	1	0	0	0	V ₄₀ ''	$V_7+(V_6-V_7) \times 800/1600$
27 _H	1	0	0	1	1	1	V ₃₉ ''	$V_7+(V_6-V_7) \times 700/1600$
26 _H	1	0	0	1	1	0	V ₃₈ ''	$V_7+(V_6-V_7) \times 600/1600$
25 _H	1	0	0	1	0	1	V ₃₇ ''	$V_7+(V_6-V_7) \times 500/1600$
24 _H	1	0	0	1	0	0	V ₃₆ ''	$V_7+(V_6-V_7) \times 400/1600$
23 _H	1	0	0	0	1	1	V ₃₅ ''	$V_7+(V_6-V_7) \times 300/1600$
22 _H	1	0	0	0	1	0	V ₃₄ ''	$V_7+(V_6-V_7) \times 200/1600$
21 _H	1	0	0	0	0	1	V ₃₃ ''	$V_7+(V_6-V_7) \times 100/1600$
20 _H	1	0	0	0	0	0	V ₃₂ ''	V ₇
1F _H	0	1	1	1	1	1	V ₃₁ ''	$V_8+(V_7-V_8) \times 2650/2750$
1E _H	0	1	1	1	1	0	V ₃₀ ''	$V_8+(V_7-V_8) \times 2550/2750$
1D _H	0	1	1	1	0	1	V ₂₉ ''	$V_8+(V_7-V_8) \times 2450/2750$
1C _H	0	1	1	1	0	0	V ₂₈ ''	$V_8+(V_7-V_8) \times 2350/2750$
1B _H	0	1	1	0	1	1	V ₂₇ ''	$V_8+(V_7-V_8) \times 2250/2750$
1A _H	0	1	1	0	1	0	V ₂₆ ''	$V_8+(V_7-V_8) \times 2100/2750$
19 _H	0	1	1	0	0	1	V ₂₅ ''	$V_8+(V_7-V_8) \times 1950/2750$
18 _H	0	1	1	0	0	0	V ₂₄ ''	$V_8+(V_7-V_8) \times 1800/2750$
17 _H	0	1	0	1	1	1	V ₂₃ ''	$V_8+(V_7-V_8) \times 1650/2750$
16 _H	0	1	0	1	1	0	V ₂₂ ''	$V_8+(V_7-V_8) \times 1450/2750$
15 _H	0	1	0	1	0	1	V ₂₁ ''	$V_8+(V_7-V_8) \times 1250/2750$
14 _H	0	1	0	1	0	0	V ₂₀ ''	$V_8+(V_7-V_8) \times 1050/2750$
13 _H	0	1	0	0	1	1	V ₁₉ ''	$V_8+(V_7-V_8) \times 800/2750$
12 _H	0	1	0	0	1	0	V ₁₈ ''	$V_8+(V_7-V_8) \times 500/2750$
11 _H	0	1	0	0	0	1	V ₁₇ ''	$V_8+(V_7-V_8) \times 300/2750$
10 _H	0	1	0	0	0	0	V ₁₆ ''	V ₈
0F _H	0	0	1	1	1	1	V ₁₅ ''	$V_9+(V_8-V_9) \times 7750/8050$
0E _H	0	0	1	1	1	0	V ₁₄ ''	$V_9+(V_8-V_9) \times 7450/8050$
0D _H	0	0	1	1	0	1	V ₁₃ ''	$V_9+(V_8-V_9) \times 7100/8050$
0C _H	0	0	1	1	0	0	V ₁₂ ''	$V_9+(V_8-V_9) \times 6750/8050$
0B _H	0	0	1	0	1	1	V ₁₁ ''	$V_9+(V_8-V_9) \times 6400/8050$
0A _H	0	0	1	0	1	0	V ₁₀ ''	$V_9+(V_8-V_9) \times 6000/8050$
09 _H	0	0	1	0	0	1	V ₉ ''	$V_9+(V_8-V_9) \times 5600/8050$
08 _H	0	0	1	0	0	0	V ₈ ''	$V_9+(V_8-V_9) \times 5100/8050$
07 _H	0	0	0	1	1	1	V ₇ ''	$V_9+(V_8-V_9) \times 4600/8050$
06 _H	0	0	0	1	1	0	V ₆ ''	$V_9+(V_8-V_9) \times 4050/8050$
05 _H	0	0	0	1	0	1	V ₅ ''	$V_9+(V_8-V_9) \times 3500/8050$
04 _H	0	0	0	1	0	0	V ₄ ''	$V_9+(V_8-V_9) \times 2900/8050$
03 _H	0	0	0	0	1	1	V ₃ ''	$V_9+(V_8-V_9) \times 2250/8050$
02 _H	0	0	0	0	1	0	V ₂ ''	$V_9+(V_8-V_9) \times 1550/8050$
01 _H	0	0	0	0	0	1	V ₁ ''	$V_9+(V_8-V_9) \times 800/8050$
00 _H	0	0	0	0	0	0	V ₀ ''	V ₉

m	(Ω)
r ₆₂	800
r ₆₁	500
r ₆₀	300
r ₅₉	250
r ₅₈	250
r ₅₇	200
r ₅₆	200
r ₅₅	150
r ₅₄	150
r ₅₃	150
r ₅₂	100
r ₅₁	100
r ₅₀	100
r ₄₉	100
r ₄₈	100
r ₄₇	100
r ₄₆	100
r ₄₅	100
r ₄₄	100
r ₄₃	100
r ₄₂	100
r ₄₁	100
r ₄₀	100
r ₃₉	100
r ₃₈	100
r ₃₇	100
r ₃₆	100
r ₃₅	100
r ₃₄	100
r ₃₃	100
r ₃₂	100
r ₃₁	100
r ₃₀	100
r ₂₉	100
r ₂₈	100
r ₂₇	100
r ₂₆	150
r ₂₅	150
r ₂₄	150
r ₂₃	150
r ₂₂	200
r ₂₁	200
r ₂₀	200
r ₁₉	250
r ₁₈	250
r ₁₇	250
r ₁₆	300
r ₁₅	300
r ₁₄	300
r ₁₃	350
r ₁₂	350
r ₁₁	350
r ₁₀	400
r ₉	400
r ₈	500
r ₇	500
r ₆	550
r ₅	550
r ₄	600
r ₃	650
r ₂	700
r ₁	750
r ₀	800
r _{total}	15850

Caution Between V₄ and V₅ terminal is not connected in the chip.

3. RELATIONSHIP BETWEEN INPUT DATA AND OUTPUT PIN

Data format: 6 bits × 2 RGBs (6 dots)

Input width : 36 bits (2-pixel data)

R,/L = H (Right shift)

Output	S ₁	S ₂	S ₃	S ₄	...	S ₃₈₃	S ₃₈₄
Data	D ₀₀ to D ₀₅	D ₁₀ to D ₁₅	D ₂₀ to D ₂₅	D ₃₀ to D ₃₅	...	D ₄₀ to D ₄₅	D ₅₀ to D ₅₅

R,/L = L (Left shift)

Output	S ₁	S ₂	S ₃	S ₄	...	S ₃₈₃	S ₃₈₄
Data	D ₀₀ to D ₀₅	D ₁₀ to D ₁₅	D ₂₀ to D ₂₅	D ₃₀ to D ₃₅	...	D ₄₀ to D ₄₅	D ₅₀ to D ₅₅

POL	S _{2n-1} ^{Note}	S _{2n} ^{Note}
L	V ₀ to V ₄	V ₅ to V ₉
H	V ₅ to V ₉	V ₀ to V ₄

Note S_{2n-1} (Odd output), S_{2n} (Even output)

4. RELATIONSHIP BETWEEN STB, POL, AND OUTPUT WAVEFORM

The output voltage is written to the LCD panel synchronized with the STB falling edge.

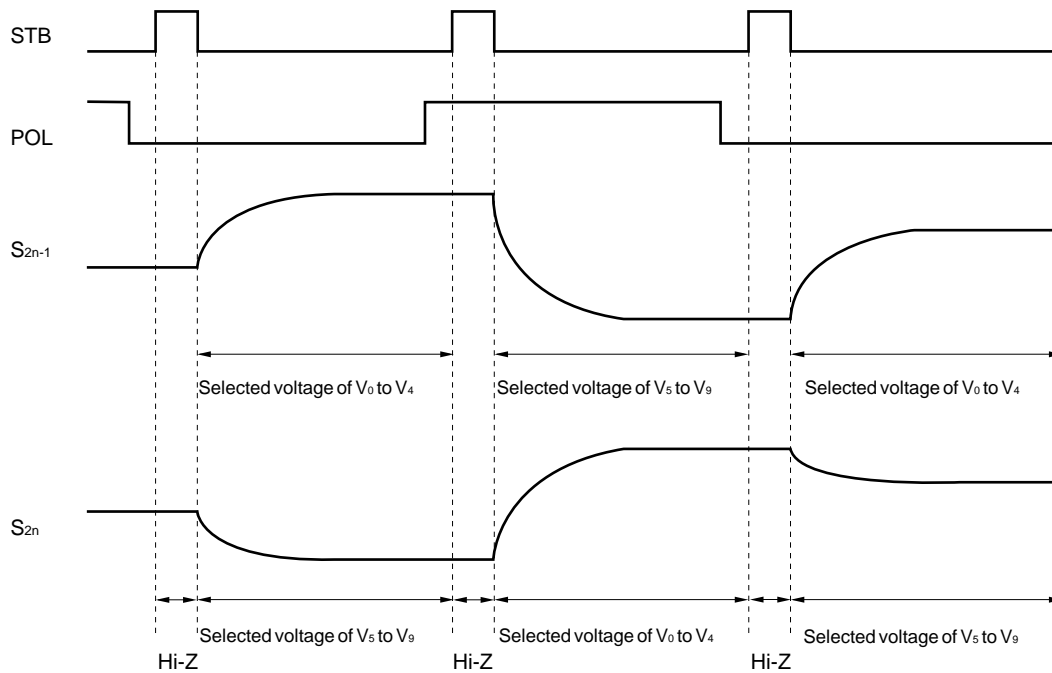

5. ELECTRICAL SPECIFICATION

Absolute Maximum Ratings ($T_A = +25\text{ }^\circ\text{C}$, $V_{SS1} = V_{SS2} = 0\text{ V}$)

Parameter	Symbol	Rating	Unit
Logic Part Supply Voltage	V_{DD1}	-0.5 to +5.0	V
Driver Part Supply Voltage	V_{DD2}	-0.5 to +10.0	V
Logic Part Input Voltage	V_{I1}	-0.5 to $V_{DD1} + 0.5$	V
Driver Part Input Voltage	V_{I2}	-0.5 to $V_{DD2} + 0.5$	V
Logic Part Output Voltage	V_{O1}	-0.5 to $V_{DD1} + 0.5$	V
Driver Part Output Voltage	V_{O2}	-0.5 to $V_{DD2} + 0.5$	V
Operating Temperature Range	T_A	-10 to +75	°C
Storage Temperature Range	T_{stg}	-55 to +125	°C

Caution If the absolute maximum rating of even one of the above parameters is exceeded even momentarily, the quality of the product may be degraded. Absolute maximum ratings, therefore, specify the values exceeding which the product may be physically damaged. Be sure to use the product within the range of the absolute maximum ratings.

Recommended Operating Range ($T_A = -10\text{ to }+75\text{ }^\circ\text{C}$, $V_{SS1} = V_{SS2} = 0\text{ V}$)

Parameter	Symbol	MIN.	TYP.	MAX.	Unit
Logic Part Supply Voltage	V_{DD1}	3.0	3.3	3.6	V
Driver Part Supply Voltage	V_{DD2}	8.0	8.5	9.0	V
High-Level Input Voltage	V_{IH}	$0.7 V_{DD1}$		V_{DD1}	V
Low-Level Input Voltage	V_{IL}	0		$0.3 V_{DD1}$	V
γ -Corrected Voltage	V_0 to V_9	V_{SS2}		V_{DD2}	V
Driver Part Output Voltage	V_O	$V_{SS2} + 0.1$		$V_{DD2} - 0.1$	V
Maximum Clock Frequency	f_{MAX}	40			MHz

Electrical Specifications (T_A = -10 to +75 °C, V_{DD1} = 3.3 V ±0.3 V, V_{DD2} = 8.5 V ±0.5 V, V_{SS1} = V_{SS2} = 0 V)

Parameter	Symbol	Condition	MIN.	TYP.	MAX.	Unit	
Input Leak Current	I _{IL}				±1.0	μ A	
High-Level Output Voltage	V _{OH}	STHR (STHL), I _{OH} = 0 mA	V _{DD1} - 0.1			V	
Low-Level Output Voltage	V _{OL}	STHR (STHL), I _{OL} = 0 mA			0.1	V	
γ-Corrected Supply Current	I _γ	V ₀ to V ₄ = V ₅ to V ₉ = 4.0 V	V ₀ pin, V ₄ pin	126	252	504	μ A
			V ₅ pin, V ₉ pin	-504	-252	-126	μ A
Driver Output Current	I _{VOH}	V _X = 7.0 V, V _{OUT} = 6.5 V ^{Note}			-30	μ A	
	I _{VOL}	V _X = 1.0 V, V _{OUT} = 1.5 V ^{Note}	30			μ A	
Output Voltage Deviation	ΔV _O	V _{DD1} = 3.3 V, V _{DD2} = 8.5 V, V _{OUT} = 2.0 V, 4.25 V, 6.5 V		±7	±20	mV	
Output swing difference deviation	ΔV _{P-P}			±2	±15	mV	
Output Voltage Range	V _O	Input data	0.1		V _{DD2} - 0.1	V	
Logic Part Dynamic Current Consumption	I _{DD1}	V _{DD1} , with no load		2.0	10	mA	
Driver Part Dynamic Current Consumption	I _{DD2}	V _{DD2} , with no load		3.0	10	mA	

Note V_X refers to the output voltage of analog output pins S₁ to S₃₈₄.
V_{OUT} refers to the voltage applied to analog output pins S₁ to S₃₈₄.

- Cautions**
1. The STB cycle is defined to be 20 μs at f_{CLK} = 40 MHz.
 2. The TYP. values refer to an all black or all white input pattern. The MAX. value refers to the measured values in the dot checkerboard input pattern.
 3. Refers to the current consumption per driver when cascades are connected under the assumption of XGA single-sided mounting (8 units).

Switching Characteristics (T_A = -10 to +75 °C, V_{DD1} = 3.3 V ±0.3 V, V_{DD2} = 8.5 V ±0.5 V, V_{SS1} = V_{SS2} = 0 V)

Parameter	Symbol	Condition	MIN.	TYP.	MAX.	Unit
Start Pulse Delay Time	t _{PLH1}	C _L = 10 pF		10	20	ns
Driver Output Delay Time	t _{PLH2}	C _L = 75 pF, R _L = 5 kΩ, V _{DD1} = 3.3 V, V _{DD2} = 9.0 V		2.5	4	μ s
	t _{PLH3}			5	7	μ s
	t _{PHL2}			2.5	4	μ s
	t _{PHL3}			5	7	μ s
Input Capacitance	C _{I1}	STHR (STHL) excluded, T _A = 25°C		5	10	pF
	C _{I2}	STHR (STHL), T _A = 25°C		5	10	pF

Measurement Condition

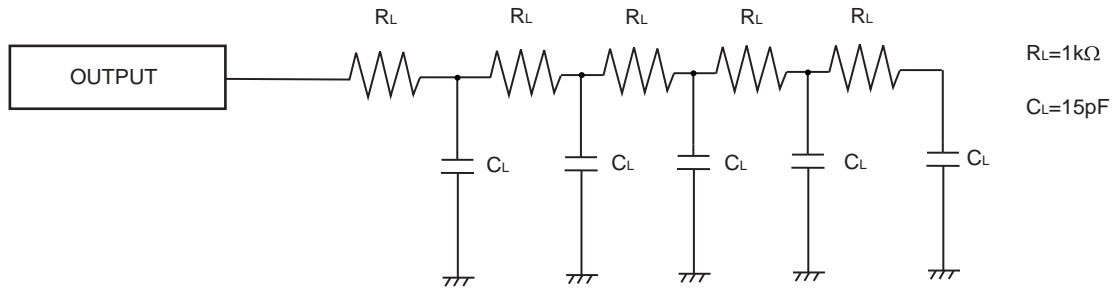

Timing Requirement ($T_A = -10$ to $+75$ °C, $V_{DD1} = 3.3$ V ± 0.3 V, $V_{SS1} = V_{SS2} = 0$ V)

Parameter	Symbol	Condition	MIN.	TYP.	MAX.	Unit
Clock Pulse Width	PW_{CLK}		25			ns
Clock Pulse High Period	$PW_{CLK(H)}$		4			ns
Clock Pulse Low Period	$PW_{CLK(L)}$		4			ns
Data Setup Time	t_{SETUP1}		4			ns
Data Hold Time	t_{HOLD1}		0			ns
Start Pulse Setup Time	t_{SETUP2}		4			ns
Start Pulse Hold Time	t_{HOLD2}		0			ns
POL2 Setup Time	t_{SETUP3}		4			ns
POL2 Hold Time	t_{HOLD3}		0			ns
Start Pulse Low Period	t_{SPL}		6			ns
STB Pulse Width	PW_{STB}		2			CLK
					4	μs
Data Invalid Period	t_{INV}		1			CLK
Last Data Timing	t_{LDT}		2			CLK
★ CLK-STB Time	$t_{CLK-STB}$	CLK \uparrow \rightarrow STB \uparrow	6			ns
★ STB-CLK Time	$t_{STB-CLK}$	STB \uparrow \rightarrow CLK \uparrow	6			ns
Time Between STB and Start Pulse	$t_{STB-STH}$	STB \uparrow \rightarrow STHR(STHL) \uparrow	2			CLK
POL-STB Time	$t_{POL-STB}$	POL \uparrow or \downarrow \rightarrow STB \uparrow	-5			ns
STB-POL Time	$t_{STB-POL}$	STB \downarrow \rightarrow POL \downarrow or \uparrow	6			ns

*** 6. SWITCHING CHARACTERISTICS WAVEFORM (R_s/L = H)**

(Unless otherwise specified, the input level is defined to be $V_{IH} = 0.7 V_{DD1}$, $V_{IL} = 0.3 V_{DD1}$.)

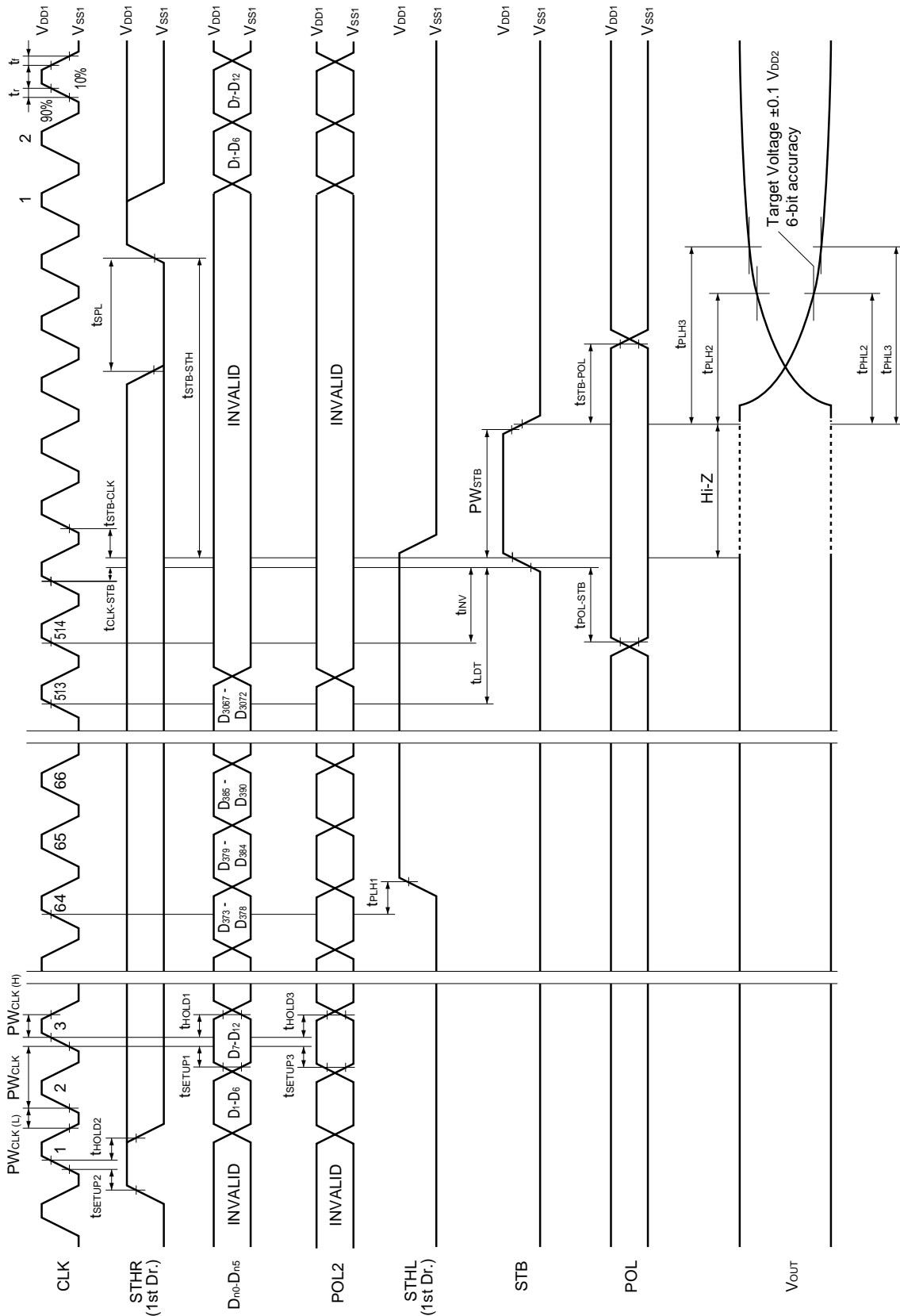

7. RECOMMENDED SOLDERING CONDITIONS

The following conditions must be met for soldering conditions of the μ PD16732.

For more details, refer to the **Semiconductor Device Mounting Technology Manual (C10535E)**.

Please consult with our sales offices in case other soldering process is used, or in case the soldering is done under different conditions.

Type of Surface Mount Device

μ PD16732N-xxx : TCP (TAB package)

Mounting Condition	Mounting Method	Condition
Thermocompression	Soldering	Heating tool 300 to 350°C: heating for 2 to 3 seconds: pressure 100g (per solder)
	ACF (Adhesive Conductive Film)	Temporary bonding 70 to 100°C: pressure 3 to 8 kg/cm ² : time 3 to 5 secs. Real bonding 165 to 180°C: pressure 25 to 45 kg/cm ² : time 30 to 40 secs. (When using the anisotropy conductive film SUMIZAC1003 of Sumitomo Bakelite, Ltd.)

Caution To find out the detailed conditions for packaging the ACF part, please contact the ACF manufacturing company. Be sure to avoid using two or more packaging methods at a time.

[MEMO]

NOTES FOR CMOS DEVICES**① PRECAUTION AGAINST ESD FOR SEMICONDUCTORS**

Note:

Strong electric field, when exposed to a MOS device, can cause destruction of the gate oxide and ultimately degrade the device operation. Steps must be taken to stop generation of static electricity as much as possible, and quickly dissipate it once, when it has occurred. Environmental control must be adequate. When it is dry, humidifier should be used. It is recommended to avoid using insulators that easily build static electricity. Semiconductor devices must be stored and transported in an anti-static container, static shielding bag or conductive material. All test and measurement tools including work bench and floor should be grounded. The operator should be grounded using wrist strap. Semiconductor devices must not be touched with bare hands. Similar precautions need to be taken for PW boards with semiconductor devices on it.

② HANDLING OF UNUSED INPUT PINS FOR CMOS

Note:

No connection for CMOS device inputs can be cause of malfunction. If no connection is provided to the input pins, it is possible that an internal input level may be generated due to noise, etc., hence causing malfunction. CMOS devices behave differently than Bipolar or NMOS devices. Input levels of CMOS devices must be fixed high or low by using a pull-up or pull-down circuitry. Each unused pin should be connected to V_{DD} or GND with a resistor, if it is considered to have a possibility of being an output pin. All handling related to the unused pins must be judged device by device and related specifications governing the devices.

③ STATUS BEFORE INITIALIZATION OF MOS DEVICES

Note:

Power-on does not necessarily define initial status of MOS device. Production process of MOS does not define the initial operation status of the device. Immediately after the power source is turned ON, the devices with reset function have not yet been initialized. Hence, power-on does not guarantee out-pin levels, I/O settings or contents of registers. Device is not initialized until the reset signal is received. Reset operation must be executed immediately after power-on for devices having reset function.

Reference Documents**NEC Semiconductor Device Reliability / Quality Control System (C10983E)****Quality Grades to NEC's Semiconductor Devices (C11531E)**

- **The information in this document is subject to change without notice. Before using this document, please confirm that this is the latest version.**
 - No part of this document may be copied or reproduced in any form or by any means without the prior written consent of NEC Corporation. NEC Corporation assumes no responsibility for any errors which may appear in this document.
 - NEC Corporation does not assume any liability for infringement of patents, copyrights or other intellectual property rights of third parties by or arising from use of a device described herein or any other liability arising from use of such device. No license, either express, implied or otherwise, is granted under any patents, copyrights or other intellectual property rights of NEC Corporation or others.
 - Descriptions of circuits, software, and other related information in this document are provided for illustrative purposes in semiconductor product operation and application examples. The incorporation of these circuits, software, and information in the design of the customer's equipment shall be done under the full responsibility of the customer. NEC Corporation assumes no responsibility for any losses incurred by the customer or third parties arising from the use of these circuits, software, and information.
 - While NEC Corporation has been making continuous effort to enhance the reliability of its semiconductor devices, the possibility of defects cannot be eliminated entirely. To minimize risks of damage or injury to persons or property arising from a defect in an NEC semiconductor device, customers must incorporate sufficient safety measures in its design, such as redundancy, fire-containment, and anti-failure features.
 - NEC devices are classified into the following three quality grades:
"Standard", "Special", and "Specific". The Specific quality grade applies only to devices developed based on a customer designated "quality assurance program" for a specific application. The recommended applications of a device depend on its quality grade, as indicated below. Customers must check the quality grade of each device before using it in a particular application.
 - Standard: Computers, office equipment, communications equipment, test and measurement equipment, audio and visual equipment, home electronic appliances, machine tools, personal electronic equipment and industrial robots
 - Special: Transportation equipment (automobiles, trains, ships, etc.), traffic control systems, anti-disaster systems, anti-crime systems, safety equipment and medical equipment (not specifically designed for life support)
 - Specific: Aircraft, aerospace equipment, submersible repeaters, nuclear reactor control systems, life support systems or medical equipment for life support, etc.
- The quality grade of NEC devices is "Standard" unless otherwise specified in NEC's Data Sheets or Data Books. If customers intend to use NEC devices for applications other than those specified for Standard quality grade, they should contact an NEC sales representative in advance.