

# BIPOLAR ANALOG INTEGRATED CIRCUITS

# $\mu$ PC2757T, $\mu$ PC2758T

## SILICON MMIC 1st FREQUENCY DOWN-CONVERTER FOR MOBILE COMMUNICATIONS

### DESCRIPTION

The  $\mu$ PC2757T and  $\mu$ PC2758T are silicon monolithic integrated circuits designed as 1st down-converters for L band mobile communications. The ICs consist of mixer and local amplifier. The  $\mu$ PC2757T features low current consumption and the  $\mu$ PC2758T features improved intermodulation. From these two version, you can chose either IC corresponding to your system design.

The  $\mu$ PC2757T and  $\mu$ PC2758T are manufactured using NEC's 20 GHz fr NESAT™ III silicon bipolar process. This process uses silicon nitride passivation film and gold electrodes. These materials can protect chip surface from external pollution and prevent corrosion and migration. Thus, these products have excellent performance, uniformity and reliability.

### FEATURES

- Wide band operation :  $f_{RFin} = 0.1 \text{ GHz to } 2.0 \text{ GHz}$
- High-density surface mounting : 6-pin minimold
- Low voltage operation : Supply voltage 3.0 V TYP.
- Low power consumption 15 mW:  $\mu$ PC2757T
- Power-save function :  $\mu$ PC2757T,  $\mu$ PC2758T

### ORDERING INFORMATION

Part Number	Markings	Product Type	Package	Supplying Form
$\mu$ PC2757T-E3	C1X	Low power consumption	6-pin minimold	Embossed tape 8-mm wide. Pin 1, 2, 3 face to perforation side of the tape. QTY 3 kp/Reel.
$\mu$ PC2758T-E3	C1Y	High output IP <sub>3</sub>		

**Note** To order evaluation samples, please contact local NEC sales office. (Part number for sample order:  $\mu$ PC2757T,  $\mu$ PC2758T)

### Caution Electro-static sensitive devices

The information in this document is subject to change without notice. Before using this document, please confirm that this is the latest version.  
Not all devices/types available in every country. Please check with local NEC representative for availability and additional information.

**PIN CONNECTIONS**

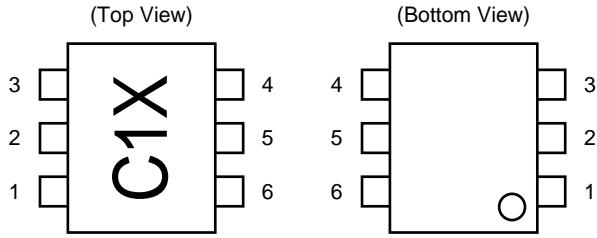

Example marking is for  $\mu$ PC2757T

Pin No.	Pin Name
1	RF input
2	GND
3	LO input
4	PS
5	V <sub>cc</sub>
6	IF output

★ **PRODUCT LINE-UP** (T<sub>A</sub> = +25 °C, V<sub>cc</sub> = 3.0 V, Z<sub>L</sub> = Z<sub>s</sub> = 50 Ω)

Part No.	Items	No RF I <sub>cc</sub> (mA)	900 MHz SSB NF (dB)	1.5 GHz SSB NF (dB)	1.9 GHz SSB NF (dB)	900 MHz CG (dB)	1.5 GHz CG (dB)	1.9 GHz CG (dB)	900 MHz IIP <sub>3</sub> (dBm)	1.5 GHz IIP <sub>3</sub> (dBm)	1.9 GHz IIP <sub>3</sub> (dBm)
$\mu$ PC2757T		5.6	10	10	13	15	15	13	-14	-14	-12
$\mu$ PC2757TB											
$\mu$ PC2758T		11	9	10	13	19	18	17	-13	-12	-11
$\mu$ PC2758TB											
$\mu$ PC8112T		8.5	9	11	11	15	13	13	-10	-9	-7
$\mu$ PC8112TB											

Part No.	Items	900 MHz P <sub>O(sat)</sub> (dBm)	1.5 GHz P <sub>O(sat)</sub> (dBm)	1.9 GHz P <sub>O(sat)</sub> (dBm)	900 MHz RF <sub>lo</sub> (dB)	1.5 GHz RF <sub>lo</sub> (dB)	1.9 GHz RF <sub>lo</sub> (dB)	IF Output Configuration	Packages
$\mu$ PC2757T		-3	-	-8	-	-	-	Emitter follower	6-pin minimold
$\mu$ PC2757TB									6-pin super minimold
$\mu$ PC2758T	+1	-	-4	-	-	-	6-pin minimold		
$\mu$ PC2758TB							6-pin super minimold		
$\mu$ PC8112T		-2.5	-3	-3	-80	-57	-55	Open collector	6-pin minimold
$\mu$ PC8112TB									6-pin super minimold

**Remark** Typical performance. Please refer to ELECTRICAL CHARACTERISTICS in detail.  
To know the associated product, please refer to each latest data sheet.

**Notice**  $\mu$ PC2757 and  $\mu$ PC2758's IIP<sub>3</sub> are calculated with  $\Delta$ IM<sub>3</sub> = 3 which is the same IM<sub>3</sub> inclination as  $\mu$ PC8112. On the other hand, OIP<sub>3</sub> of Standard characteristics in page 4 is cross point IP.

INTERNAL BLOCK DIAGRAM ( $\mu$ PC2757T,  $\mu$ PC2758T IN COMMON)

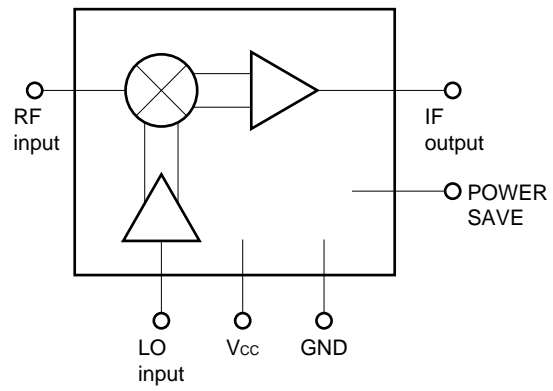

To know the detail in associated product, please refer to its latest data sheet.

**PIN EXPLANATION (BOTH  $\mu$ PC2757T, 2758T)**

Pin No.	Pin Name	Applied Voltage (V)	Pin Voltage (V) <sup>Note</sup>	Function and Application	Equivalent Circuit								
1	RF input	–	1.2	This pin is RF input for mixer designed as double balance type. This circuit contributes to suppress spurious signal with minimum LO and bias power consumption. Also this symmetrical circuit can keep specified performance insensitive to process-condition distribution.									
2	GND	GND	–	This pin is ground of IC. Must be connected to the system ground with minimum inductance. Ground pattern on the board should be formed as wide as possible. (Track length should be kept as short as possible.)	–								
3	LO input	–	1.3	This pin is LO input for local buffer designed as differential amplifier. Recommendable input level is –15 to –0 dBm. Also this symmetrical circuit can keep specified performance insensitive to process-condition distribution.									
4	PS	V <sub>cc</sub> /GND	–	This pin is for power-save function. This pin can control ON/OFF operation with bias as follows; <table border="1" style="margin: 10px auto;"> <thead> <tr> <th></th> <th>Bias: V</th> <th>Operation</th> </tr> </thead> <tbody> <tr> <td rowspan="2">V<sub>PS</sub></td> <td>≥ 2.5</td> <td>ON</td> </tr> <tr> <td>0 to 0.5</td> <td>OFF</td> </tr> </tbody> </table> Rise time/fall time using this pin are approximately 10 $\mu$ s.		Bias: V	Operation	V <sub>PS</sub>	≥ 2.5	ON	0 to 0.5	OFF	
	Bias: V	Operation											
V <sub>PS</sub>	≥ 2.5	ON											
	0 to 0.5	OFF											
5	V <sub>cc</sub>	2.7 to 3.3	–	Supply voltage 3.0 $\pm$ 0.3 V for operation. Must be connected bypass capacitor. (example: 1 000 pF) to minimize ground impedance.	–								
6	IF output	–	1.7	This pin is output from IF buffer amplifier designed as single-ended push-pull type. This pin is assigned for emitter follower output with low-impedance. In the case of connecting to high-impedance stage, please attach external matching circuit.									

**Note** Each pin voltage is measured with V<sub>cc</sub> = 3.0 V

**ABSOLUTE MAXIMUM RATINGS**

Parameter	Symbol	Conditions	Ratings	Unit
Supply Voltage	V <sub>CC</sub>	T <sub>A</sub> = +25 °C	5.5	V
PS Pin Voltage	V <sub>PS</sub>	T <sub>A</sub> = +25 °C	5.5	V
Power Dissipation of Package Allowance	P <sub>D</sub>	Mounted on 50 × 50 × 1.6 mm double sided copper clad epoxy glass board at T <sub>A</sub> = +85 °C	280	mW
Operating Ambient Temperature	T <sub>A</sub>		-40 to +85	°C
Storage Temperature	T <sub>stg</sub>		-55 to +150	°C

**RECOMMENDED OPERATING RANGE**

Parameters	Symbol	MIN.	TYP.	MAX.	Unit
Supply Voltage	V <sub>CC</sub>	2.7	3.0	3.3	V
Operating Ambient Temperature	T <sub>A</sub>	-40	+25	+85	°C
LO Input Level	P <sub>LOin</sub>	-15	-10	0	dBm

**ELECTRICAL CHARACTERISTICS (T<sub>A</sub> = +25°C, V<sub>CC</sub> = V<sub>PS</sub> = 3.0 V, P<sub>LOin</sub> = -10 dBm, Z<sub>L</sub> = Z<sub>S</sub> = 50 Ω)**

Parameters	Symbol	Conditions	μPC2757T			μPC2758T			Unit
			MIN.	TYP.	MAX.	MIN.	TYP.	MAX.	
Circuit Current	I <sub>CC</sub>	No input signal	3.7	5.6	7.7	6.6	11	14.8	dB
RF Frequency Response	f <sub>RFIn</sub>	CG ≥ (CG1 -3 dB) f <sub>IFout</sub> = 130 MHz constant	0.1		2.0	0.1		2.0	GHz
IF Frequency Response	f <sub>IFout</sub>	CG ≥ (CG1 -3 dB) f <sub>RFIn</sub> = 0.8 GHz constant	20		300	20		300	MHz
Conversion Gain 1	CG1	f <sub>RFIn</sub> = 0.8 GHz, f <sub>IFout</sub> = 130 MHz P <sub>RFIn</sub> = -40 dBm, Upper local	12	15	18	16	19	22	dB
Conversion Gain 2	CG2	f <sub>RFIn</sub> = 2.0 GHz, f <sub>IFout</sub> = 250 MHz P <sub>RFIn</sub> = -40 dBm, Lower local	10	13	16	14	17	20	dB
Single Sideband Noise Figure 1	SSB NF1	f <sub>RFIn</sub> = 0.8 GHz, f <sub>IFout</sub> = 130 MHz, Upper local		10	13		9	12	dB
Single Sideband Noise Figure 2	SSB NF2	f <sub>RFIn</sub> = 2.0 GHz, f <sub>IFout</sub> = 250 MHz, Lower local		13	16		13	15	dB
Maximum IF Output Level 1	P <sub>O(sat) 1</sub>	f <sub>RFIn</sub> = 0.8 GHz, f <sub>IFout</sub> = 130 MHz P <sub>RFIn</sub> = -10 dBm, Upper local	-11	-3		-7	+1		dBm
Maximum IF Output Level 2	P <sub>O(sat) 2</sub>	f <sub>RFIn</sub> = 2.0 GHz, f <sub>IFout</sub> = 250 MHz P <sub>RFIn</sub> = -10 dBm, Lower local	-11	-8		-7	-4		dBm

**STANDARD CHARACTERISTICS FOR REFERENCE**

(Unless otherwise specified: T<sub>A</sub> = +25°C, V<sub>CC</sub> = V<sub>PS</sub> = 3.0 V, P<sub>LOin</sub> = -10 dBm, Z<sub>L</sub> = Z<sub>S</sub> = 50 Ω)

Parameters	Symbol	Conditions	Reference Value		Unit
			μPC2757T	μPC2758T	
Output 3rd intercept point	OIP <sub>3</sub>	f <sub>RFIn</sub> = 0.8 to 2.0 GHz, f <sub>IFout</sub> = 0.1 GHz, Cross point IP	+5	+11	dBm
LO leakage at RF pin	LO <sub>rf</sub>	f <sub>LOin</sub> = 0.8 to 2.0 GHz	-35	-30	dBm
LO leakage at IF pin	LO <sub>if</sub>	f <sub>LOin</sub> = 0.8 to 2.0 GHz	-23	-15	dBm
Power-saving current	I <sub>PS</sub>	V <sub>PS</sub> = 0.5 V	0.1	0.1	μA

**Remark** IIP<sub>3</sub> is determined by comparing two method; theoretical calculation and cross point of IM<sub>3</sub> curve.

$$IIP_3 = (\Delta IM_3 \times P_{in} + CG - IM_3) \div (\Delta IM_3 - 1) \text{ (dBm)} \quad [\Delta IM_3: IM_3 \text{ curve inclination in linear range}]$$

**SCHEMATIC SUPPLEMENT FOR RF, IF SPECIFICATIONS**

**Note**

	$\mu$ PC2757T			$\mu$ PC2758T			Unit
	MIN.	TYP.	MAX.	MIN.	TYP.	MAX.	
CG1	12	15	18	16	19	22	dB
CG1 - 3 dB	9	12	15	13	16	19	dB

**RF FREQUENCY RESPONSE**

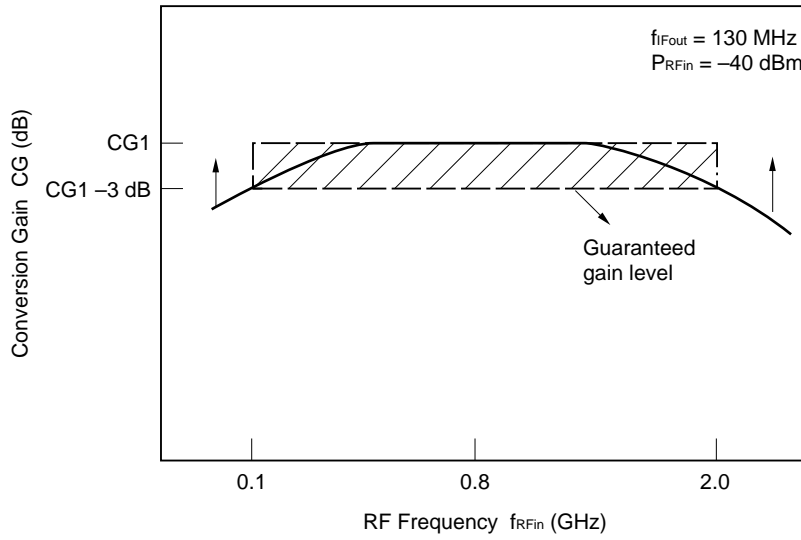

**IF FREQUENCY RESPONSE**

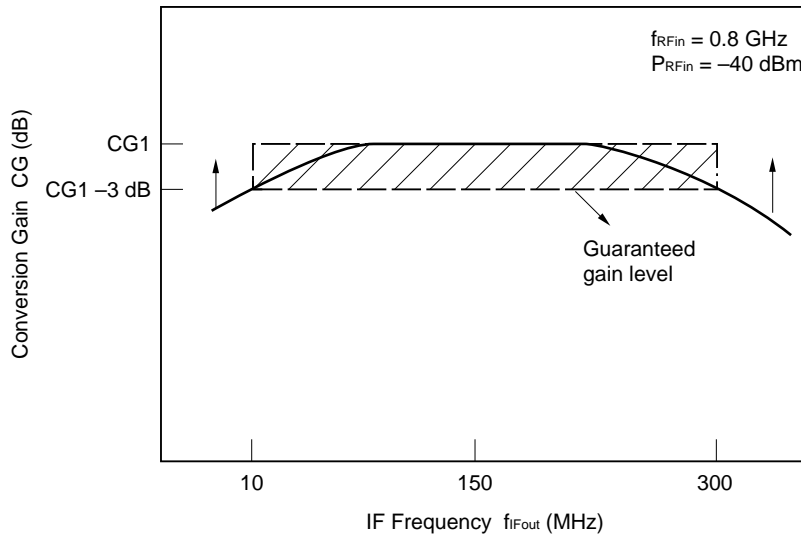

TEST CIRCUIT

$\mu$ PC2757T,  $\mu$ PC2758T

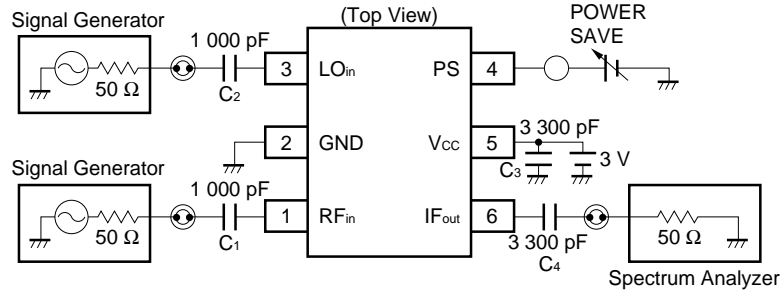

★ ILLUSTRATION OF THE TEST CIRCUIT ASSEMBLED ON EVALUATION BOARD

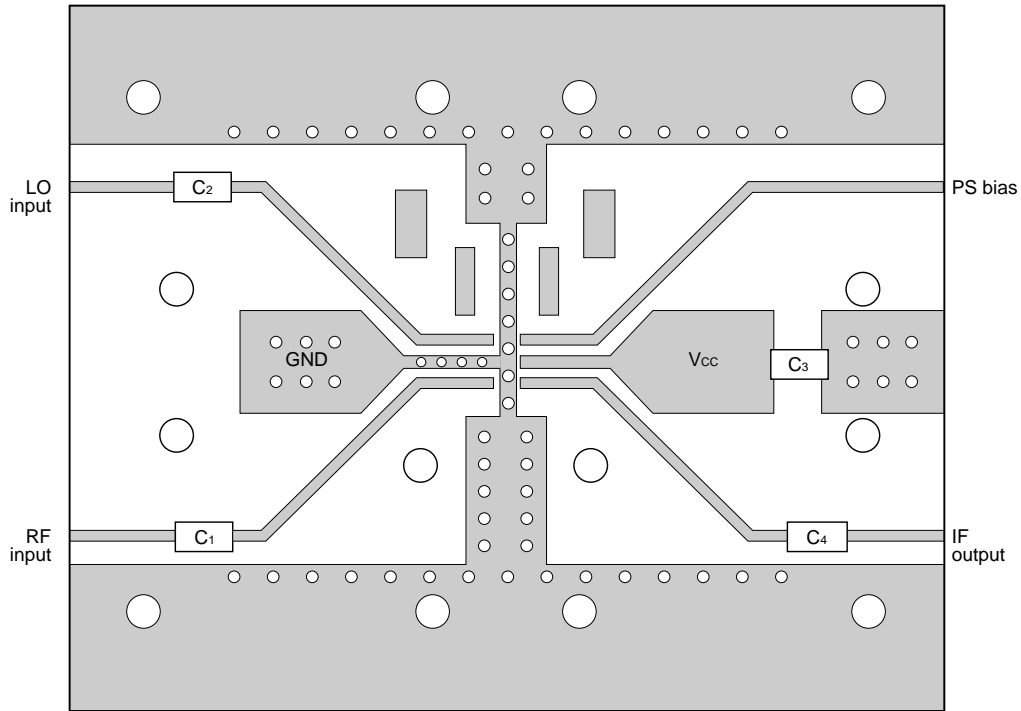

COMPONENT LIST

No.	Value
C <sub>1</sub> , C <sub>2</sub>	1 000 pF
C <sub>3</sub> to C <sub>5</sub>	3 300 pF

- Notes**
- 35 × 42 × 0.4 mm double sided copper clad polyimide board.
  - Back side: GND pattern
  - Solder plated on pattern
  - °O: Through holes

APPLICATION

This IC is guaranteed on the test circuit constructed with 50 Ω equipment and transmission line.

This IC, however, does not have 50 Ω input/output impedance, but electrical characteristics such as conversion gain and intermodulation distortion are described herein on these conditions without impedance matching. So, you should understand that conversion gain and intermodulation distortion at input level will vary when you improve VS of RF input with external circuit (50 Ω termination or impedance matching).

External circuits of the IC can be referred to following application notes.

- To RF and IF port:  $\mu$ PC2757,  $\mu$ PC2758,  $\mu$ PC8112 application note (Document No. P11997E)

TYPICAL CHARACTERISTICS (T<sub>A</sub> = +25 °C)

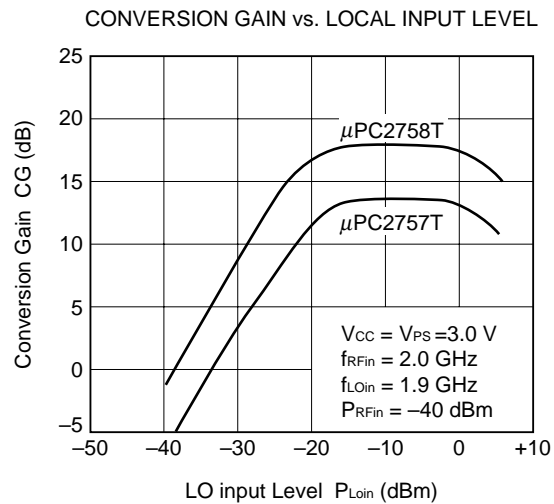
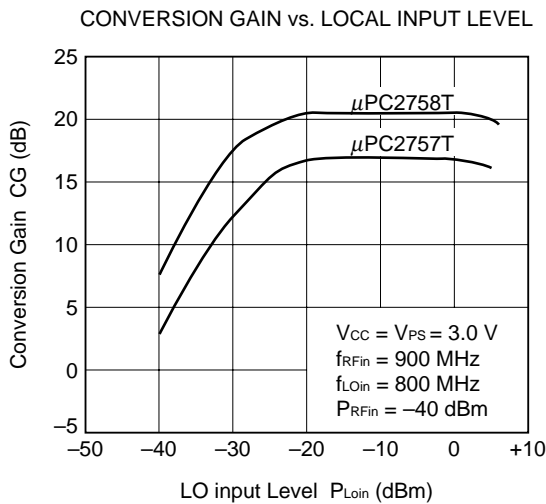
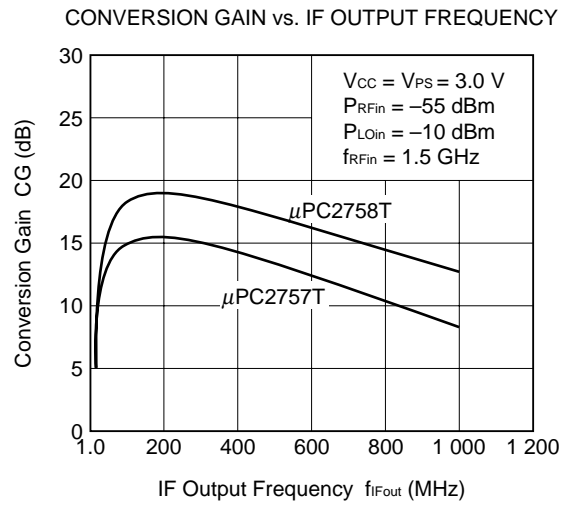
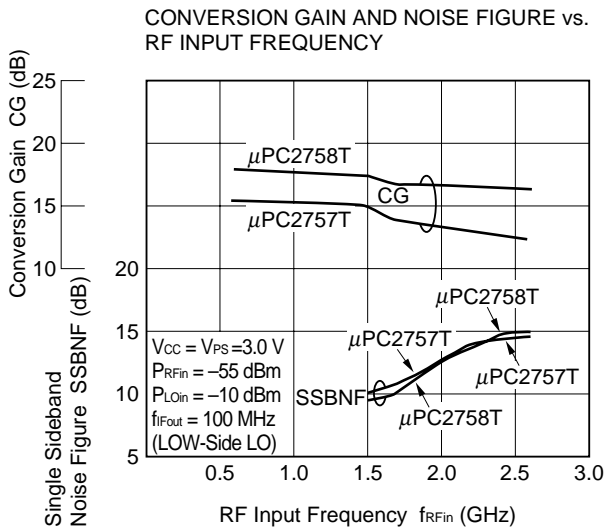
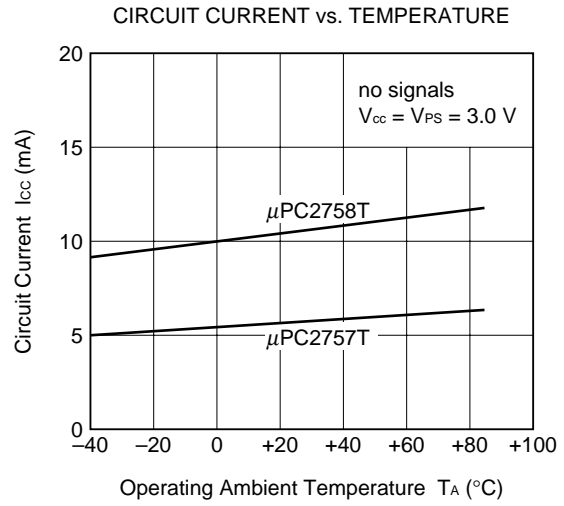
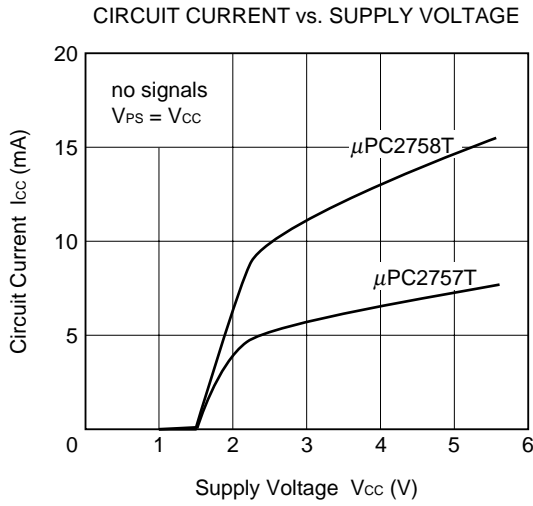



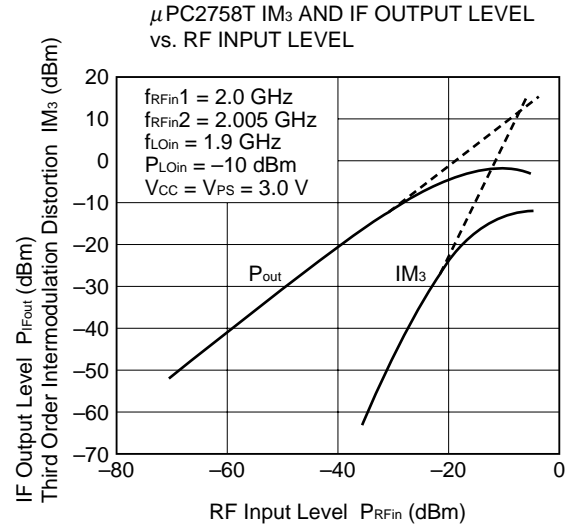
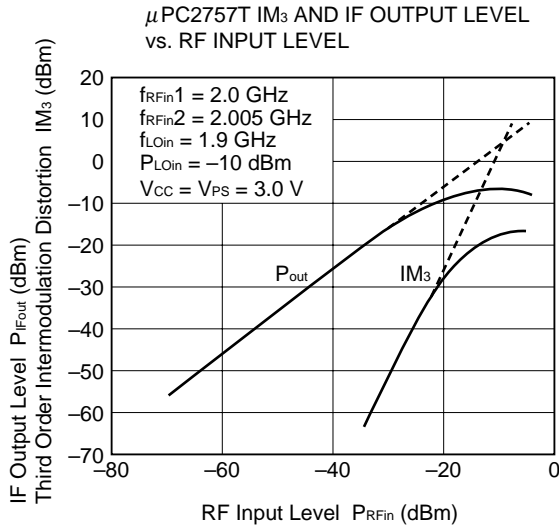
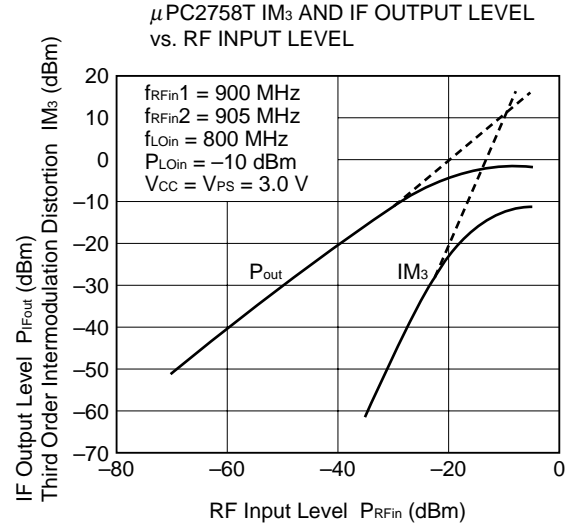
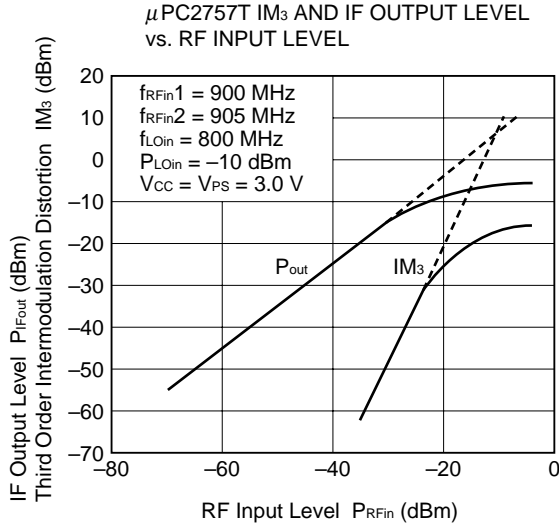

$\mu$ PC2757T LO LEAKAGE AT IF PIN  
vs. LOCAL INPUT FREQUENCY

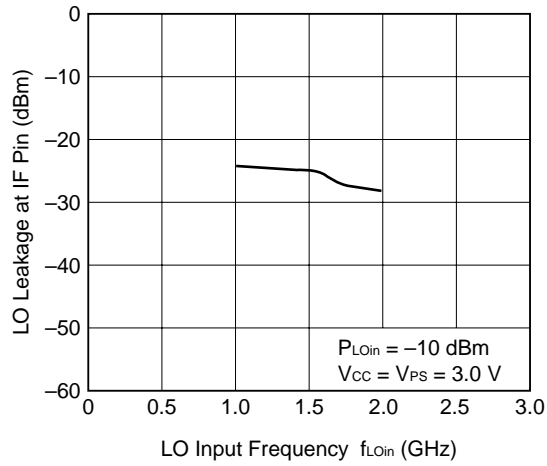

$\mu$ PC2758T LO LEAKAGE AT IF PIN  
vs. LOCAL INPUT FREQUENCY

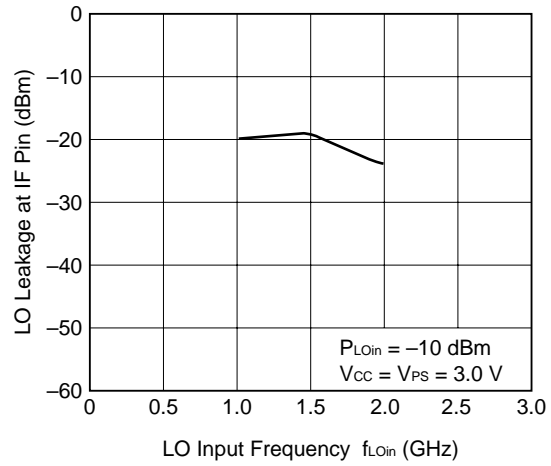

$\mu$ PC2757T LO LEAKAGE AT RF PIN  
vs. LOCAL INPUT FREQUENCY

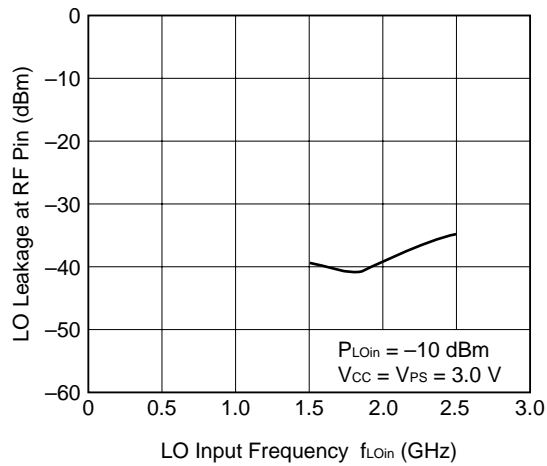

$\mu$ PC2758T LO LEAKAGE AT RF PIN  
vs. LOCAL INPUT FREQUENCY

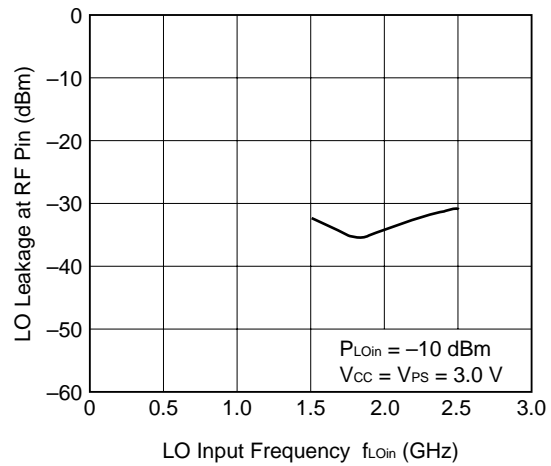

★ S-PARAMETERS  
-  $\mu$ PC2757T -

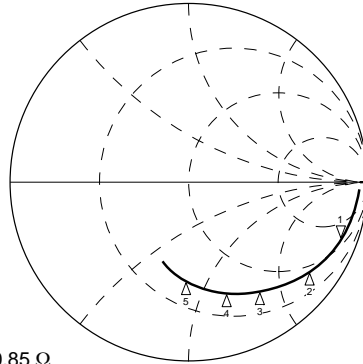

RF port  
V<sub>CC</sub>=V<sub>PS</sub>=3.0V  
1:500MHz 64.273  $\Omega$ -j250.85  $\Omega$   
2:900MHz 40.93  $\Omega$ -j141.55  $\Omega$   
3:1500MHz 31.09  $\Omega$ -j82.902  $\Omega$   
4:1900MHz 27.545  $\Omega$ -j62.115  $\Omega$   
5:2500MHz 26.459  $\Omega$ -j41.922  $\Omega$

START 0.050000000 GHz  
STOP 3.000000000 GHz

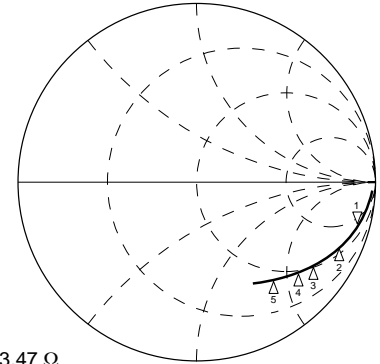

RF port  
V<sub>CC</sub>=3.0V V<sub>PS</sub>=GND  
1:500MHz 109.98  $\Omega$ -j363.47  $\Omega$   
2:900MHz 79.687  $\Omega$ -j214.84  $\Omega$   
3:1500MHz 60.195  $\Omega$ -j141.38  $\Omega$   
4:1900MHz 50.621  $\Omega$ -j114.52  $\Omega$   
5:2500MHz 42.488  $\Omega$ -j87.531  $\Omega$

START 0.050000000 GHz  
STOP 3.000000000 GHz

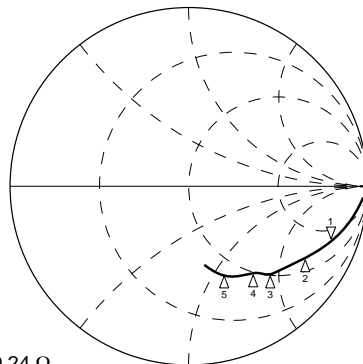

LO port  
V<sub>CC</sub>=V<sub>PS</sub>=3.0V  
1:500MHz 99.852  $\Omega$ -j220.24  $\Omega$   
2:900MHz 73.133  $\Omega$ -j139.53  $\Omega$   
3:1500MHz 52.672  $\Omega$ -j91.57  $\Omega$   
4:1900MHz 48.867  $\Omega$ -j74.281  $\Omega$   
5:2500MHz 40.842  $\Omega$ -j55.199  $\Omega$

START 0.050000000 GHz  
STOP 3.000000000 GHz

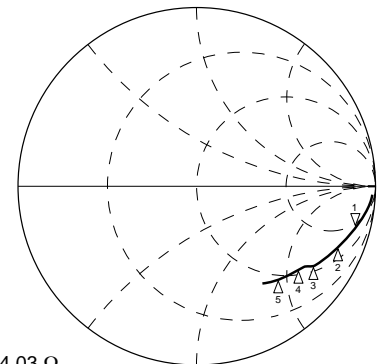

LO port  
V<sub>CC</sub>=3.0V V<sub>PS</sub>=GND  
1:500MHz 128.02  $\Omega$ -j354.03  $\Omega$   
2:900MHz 88.133  $\Omega$ -j222.33  $\Omega$   
3:1500MHz 62.516  $\Omega$ -j140.97  $\Omega$   
4:1900MHz 58.312  $\Omega$ -j117.96  $\Omega$   
5:2500MHz 45.59  $\Omega$ -j93.238  $\Omega$

START 0.050000000 GHz  
STOP 3.000000000 GHz

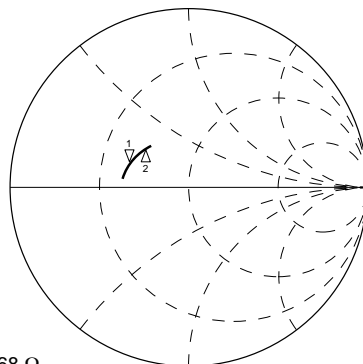

IF port  
V<sub>CC</sub>=V<sub>PS</sub>=3.0V  
1:130MHz 24.197  $\Omega$ -j7.668  $\Omega$   
2:250MHz 28.207  $\Omega$ -j13.525  $\Omega$

START 0.050000000 GHz  
STOP 0.300000000 GHz

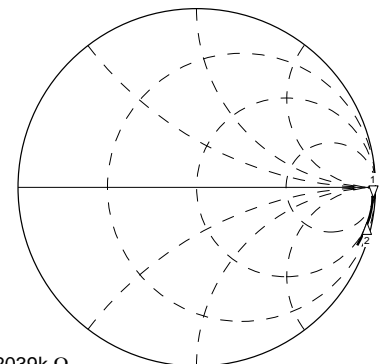

IF port  
V<sub>CC</sub>=3.0V V<sub>PS</sub>=GND  
1:130MHz 168.88  $\Omega$ -j1.2039k  $\Omega$   
2:250MHz 120.56  $\Omega$ -j652.25  $\Omega$

START 0.050000000 GHz  
STOP 0.300000000 GHz

-  $\mu$ PC2758T -

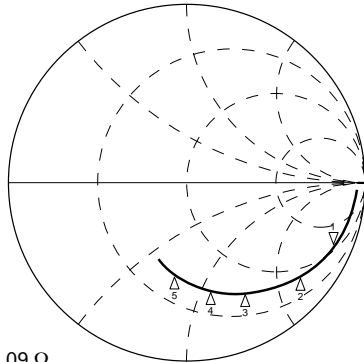

RF port

$V_{CC}=V_{PS}=3.0V$

1:500MHz	59.633 $\Omega$ -j235.09 $\Omega$
2:900MHz	37.609 $\Omega$ -j131.38 $\Omega$
3:1500MHz	29.121 $\Omega$ -j76.48 $\Omega$
4:1900MHz	26.992 $\Omega$ -j56.742 $\Omega$
5:2500MHz	26.697 $\Omega$ -j37.975 $\Omega$

START 0.050000000 GHz  
STOP 3.000000000 GHz

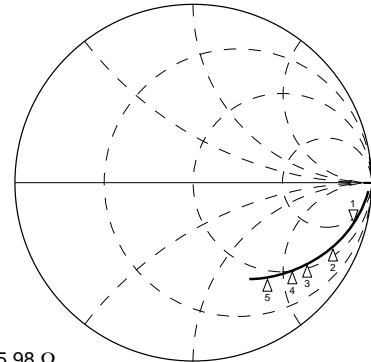

RF port

$V_{CC}=3.0V$   $V_{PS}=GND$

1:500MHz	105.94 $\Omega$ -j355.98 $\Omega$
2:900MHz	79.336 $\Omega$ -j214.39 $\Omega$
3:1500MHz	61.398 $\Omega$ -j139.99 $\Omega$
4:1900MHz	51.539 $\Omega$ -j113.45 $\Omega$
5:2500MHz	42.875 $\Omega$ -j87.09 $\Omega$

START 0.050000000 GHz  
STOP 3.000000000 GHz

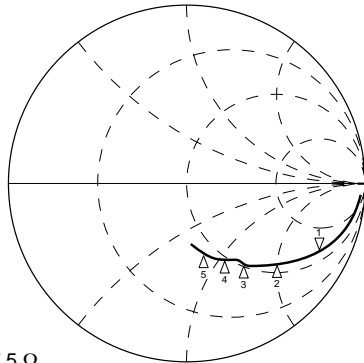

LO port

$V_{CC}=V_{PS}=3.0V$

1:500MHz	69.883 $\Omega$ -j177.5 $\Omega$
2:900MHz	59.047 $\Omega$ -j102.83 $\Omega$
3:1500MHz	49.656 $\Omega$ -j67.445 $\Omega$
4:1900MHz	46.871 $\Omega$ -j53.65 $\Omega$
5:2500MHz	42.143 $\Omega$ -j40.105 $\Omega$

START 0.050000000 GHz  
STOP 3.000000000 GHz

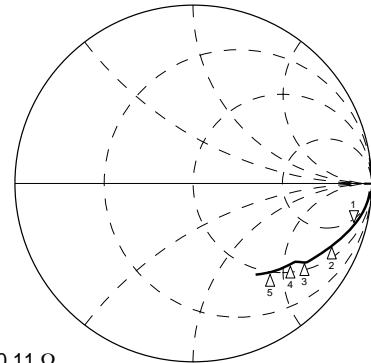

LO port

$V_{CC}=3.0V$   $V_{PS}=GND$

1:500MHz	102.48 $\Omega$ -j330.11 $\Omega$
2:900MHz	79.703 $\Omega$ -j199.25 $\Omega$
3:1500MHz	60.961 $\Omega$ -j128.63 $\Omega$
4:1900MHz	59.211 $\Omega$ -j107.32 $\Omega$
5:2500MHz	48.105 $\Omega$ -j86.215 $\Omega$

START 0.050000000 GHz  
STOP 3.000000000 GHz

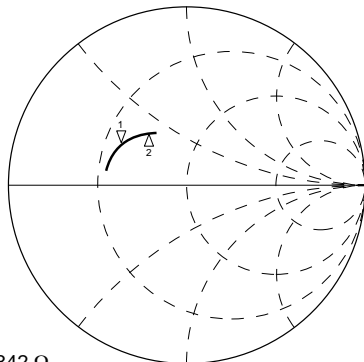

IF port

$V_{CC}=V_{PS}=3.0V$

1:130MHz	20.784 $\Omega$ -j10.842 $\Omega$
2:250MHz	27.586 $\Omega$ -j18.538 $\Omega$

START 0.050000000 GHz  
STOP 0.300000000 GHz

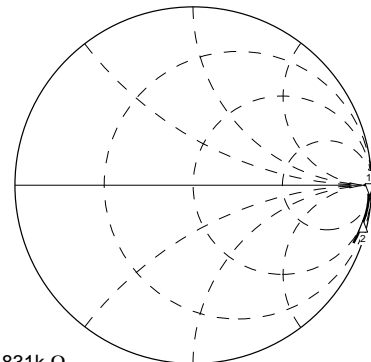

IF port

$V_{CC}=3.0V$   $V_{PS}=GND$

1:130MHz	182.06 $\Omega$ -j1.1831k $\Omega$
2:250MHz	117.16 $\Omega$ -j631.63 $\Omega$

START 0.050000000 GHz  
STOP 0.300000000 GHz

SYSTEM APPLICATION EXAMPLE

ANALOG CELLULAR TELEPHONE

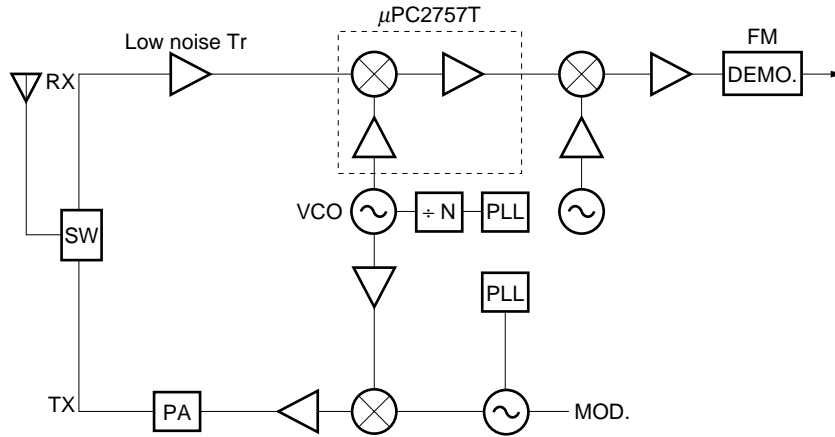

DIGITAL CELLULAR TELEPHONE

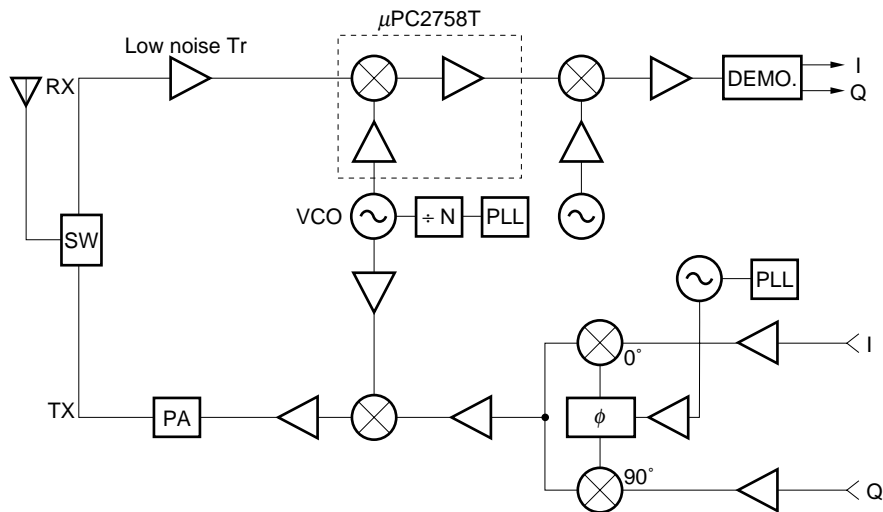

These examples show only IC's location on the system use schematically, do not present or recommend the actual application circuit in detail.

PACKAGE DIMENSIONS

6 PIN MINIMOLD (Unit: mm)

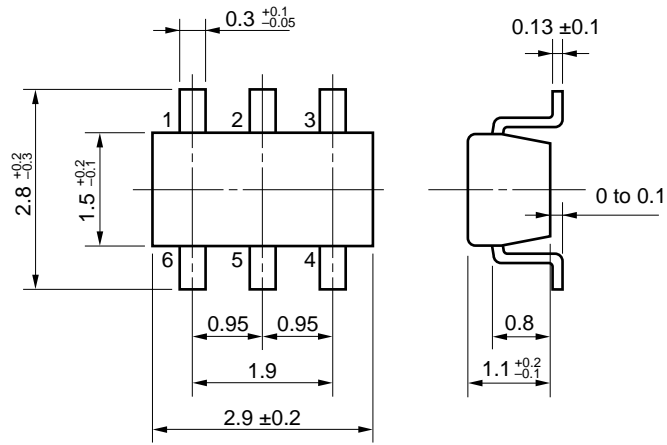

**NOTE ON CORRECT USE**

- (1) Observe precautions for handling because of electrostatic sensitive devices.
- (2) Form a ground pattern as wide as possible to minimize ground impedance (to prevent undesired oscillation).
- (3) Keep the track length of the ground pins as short as possible.
- (4) Connect a bypass capacitor (example: 1 000 pF) to the Vcc pin.

**RECOMMENDED SOLDERING CONDITIONS**

This product should be soldered under the following recommended conditions. For soldering methods and conditions other than those recommended below, contact your NEC sales representative.

Soldering Method	Soldering Conditions	Recommended Condition Symbol
Infrared Reflow	Package peak temperature: 235 °C or below Time: 30 seconds or less (at 210 °C) Count: 3, Exposure limit: None <sup>Note</sup>	IR35-00-3
VPS	Package peak temperature: 215 °C or below Time: 40 seconds or less (at 200 °C) Count: 3, Exposure limit: None <sup>Note</sup>	VP15-00-3
Wave Soldering	Soldering bath temperature: 260 °C or below Time: 10 seconds or less Count: 1, Exposure limit: None <sup>Note</sup>	WS60-00-1
Partial Heating	Pin temperature: 300 °C Time: 3 seconds or less (per side of device) Exposure limit: None <sup>Note</sup>	—

**Note** After opening the dry pack, keep it in a place below 25 °C and 65 % RH for the allowable storage period.

**Caution** Do not use different soldering methods together (except for partial heating).

For details of recommended soldering conditions for surface mounting, refer to information document SEMICONDUCTOR DEVICE MOUNTING TECHNOLOGY MANUAL (C10535E).

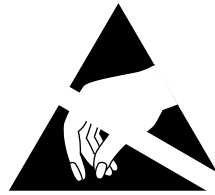

## ATTENTION

OBSERVE PRECAUTIONS  
FOR HANDLING  
ELECTROSTATIC  
SENSITIVE  
DEVICES

**NESAT (NEC Silicon Advanced Technology) is a trademark of NEC Corporation.**

- **The information in this document is subject to change without notice. Before using this document, please confirm that this is the latest version.**
- No part of this document may be copied or reproduced in any form or by any means without the prior written consent of NEC Corporation. NEC Corporation assumes no responsibility for any errors which may appear in this document.
- NEC Corporation does not assume any liability for infringement of patents, copyrights or other intellectual property rights of third parties by or arising from use of a device described herein or any other liability arising from use of such device. No license, either express, implied or otherwise, is granted under any patents, copyrights or other intellectual property rights of NEC Corporation or others.
- Descriptions of circuits, software, and other related information in this document are provided for illustrative purposes in semiconductor product operation and application examples. The incorporation of these circuits, software, and information in the design of the customer's equipment shall be done under the full responsibility of the customer. NEC Corporation assumes no responsibility for any losses incurred by the customer or third parties arising from the use of these circuits, software, and information.
- While NEC Corporation has been making continuous effort to enhance the reliability of its semiconductor devices, the possibility of defects cannot be eliminated entirely. To minimize risks of damage or injury to persons or property arising from a defect in an NEC semiconductor device, customers must incorporate sufficient safety measures in its design, such as redundancy, fire-containment, and anti-failure features.
- NEC devices are classified into the following three quality grades:  
"Standard", "Special", and "Specific". The Specific quality grade applies only to devices developed based on a customer designated "quality assurance program" for a specific application. The recommended applications of a device depend on its quality grade, as indicated below. Customers must check the quality grade of each device before using it in a particular application.

Standard: Computers, office equipment, communications equipment, test and measurement equipment, audio and visual equipment, home electronic appliances, machine tools, personal electronic equipment and industrial robots

Special: Transportation equipment (automobiles, trains, ships, etc.), traffic control systems, anti-disaster systems, anti-crime systems, safety equipment and medical equipment (not specifically designed for life support)

Specific: Aircraft, aerospace equipment, submersible repeaters, nuclear reactor control systems, life support systems or medical equipment for life support, etc.

The quality grade of NEC devices is "Standard" unless otherwise specified in NEC's Data Sheets or Data Books. If customers intend to use NEC devices for applications other than those specified for Standard quality grade, they should contact an NEC sales representative in advance.