

NPN SILICON EPITAXIAL TRANSISTOR
(WITH BUILT-IN 2 \times 2SC5006)
FLAT-LEAD 6-PIN THIN-TYPE ULTRA SUPER MINIMOLD

DESCRIPTION

The μ PA801TC has built-in low-voltage two transistors which are designed to amplify low noise in the VHF band to the UHF band.

FEATURES

- Low noise: NF = 1.2 dB TYP. @ f = 1 GHz, $V_{CE} = 3$ V, $I_c = 7$ mA
- High gain: $|S_{21e}|^2 = 9.0$ dB TYP. @ f = 1 GHz, $V_{CE} = 3$ V, $I_c = 7$ mA
- Flat-lead 6-pin thin-type ultra super minimold package
- Built-in 2 transistors (2 \times 2SC5006)

ORDERING INFORMATION

Part Number	Package	Quantity	Supplying Form
μ PA801TC	Flat-lead 6-pin thin-type ultra super minimold	Loose products (50 pcs)	Embossed tape 8 mm wide. Pin 6 (Q1 Base), Pin 5 (Q2 Base), Pin 4 (Q2 Emitter) face to perforation side of the tape.
μ PA801TC-T1		Taping products (3 kp/reel)	

Remark To order evaluation samples, please contact your local NEC sales office. (Part number for sample order: μ PA801TC. Unit sample quantity is 50 pcs.)

ABSOLUTE MAXIMUM RATINGS ($T_A = +25^\circ\text{C}$)

Parameter	Symbol	Ratings	Unit
Collector to Base Voltage	V_{CBO}	20	V
Collector to Emitter Voltage	V_{CEO}	12	V
Emitter to Base Voltage	V_{EBO}	3	V
Collector Current	I_c	100	mA
Total Power Dissipation	P_T Note	200 in 1 element 230 in 2 elements	mW
Junction Temperature	T_j	150	$^\circ\text{C}$
Storage Temperature	T_{stg}	-65 to +150	$^\circ\text{C}$

Note Mounted on 1.08 cm² \times 1.0 mm glass epoxy substrate.

Caution Electro-static sensitive devices

The information in this document is subject to change without notice. Before using this document, please confirm that this is the latest version.
Not all devices/types available in every country. Please check with local NEC representative for availability and additional information.

ELECTRICAL CHARACTERISTICS (T_A = +25 °C)

Parameter	Symbol	Conditions	MIN.	TYP.	MAX.	Unit
Collector Cutoff Current	I _{CB0}	V _{CB} = 10 V, I _E = 0	–	–	1.0	μA
Emitter Cutoff Current	I _{EB0}	V _{EB} = 1 V, I _C = 0	–	–	1.0	μA
DC Current Gain	h _{FE}	V _{CE} = 3 V, I _C = 7 mA ^{Note 1}	70	–	250	
Gain Bandwidth Product	f _T	V _{CE} = 3 V, I _C = 7 mA, f = 1 GHz	3.0	4.5	–	GHz
Feedback Capacitance	C _{re}	V _{CB} = 3 V, I _E = 0, f = 1 MHz ^{Note 2}	–	0.7	1.5	pF
Insertion Power Gain	S _{21e} ²	V _{CE} = 3 V, I _C = 7 mA, f = 1 GHz	7.0	9.0	–	dB
Noise Figure	NF	V _{CE} = 3 V, I _C = 7 mA, f = 1 GHz	–	1.2	2.5	dB

Notes 1. Pulse Measurement: PW ≤ 350 μs, Duty Cycle ≤ 2 %

2. Measured with 3-pin bridge, emitter and case should be connected to guard pin of bridge.

h_{FE} CLASSIFICATION

Rank	FB	GB
Marking	70	71
h _{FE} Value	70 to 140	125 to 250

TYPICAL CHARACTERISTICS ($T_A = +25\text{ }^\circ\text{C}$)

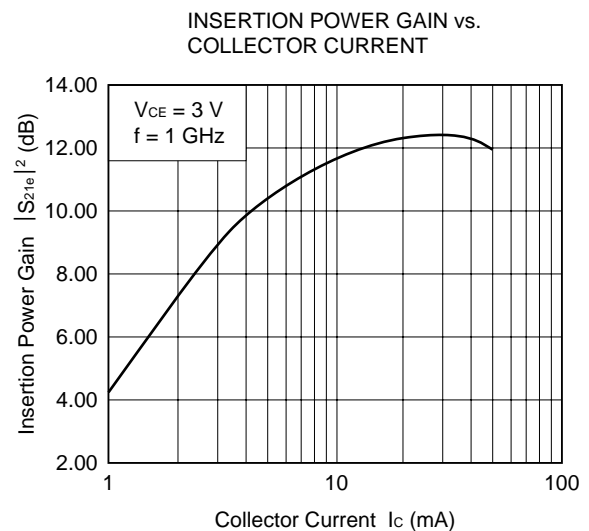
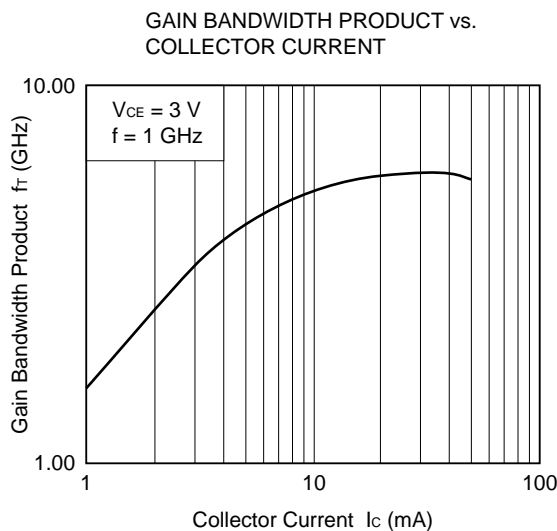
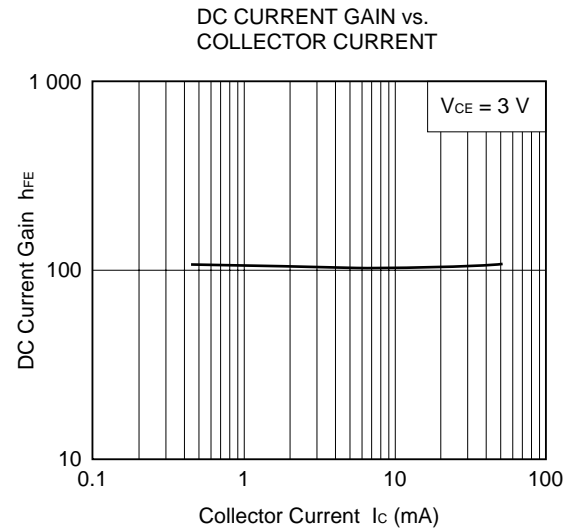
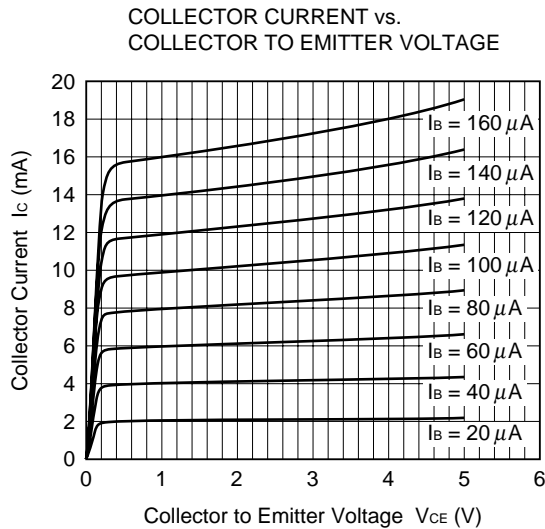
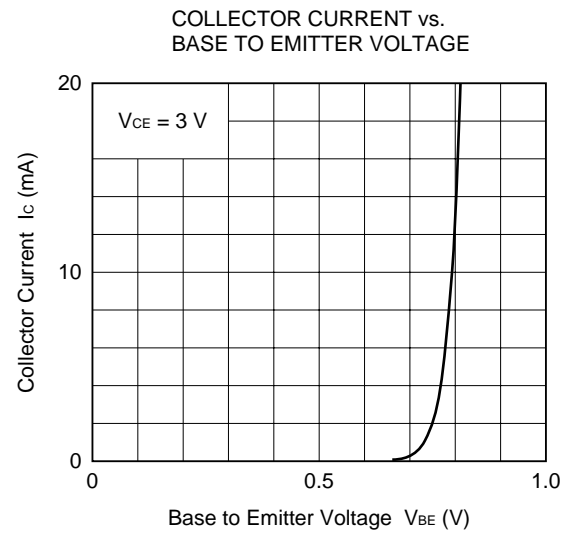
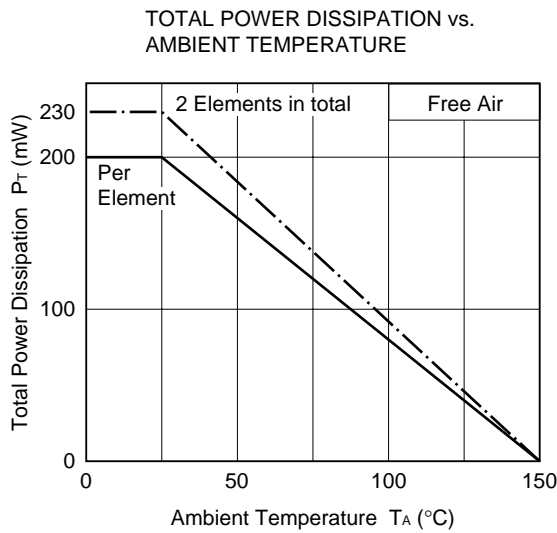

NOISE FIGURE vs. COLLECTOR CURRENT

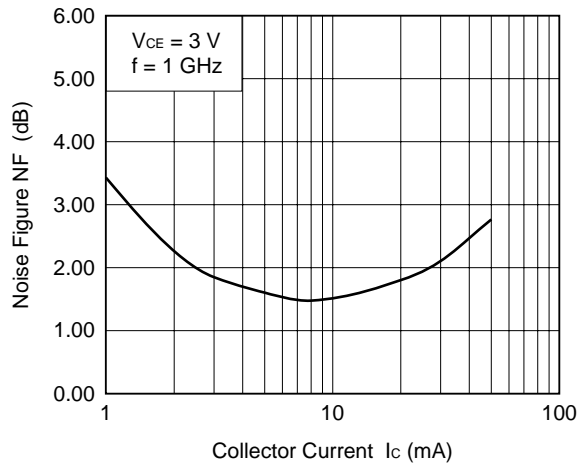

INSERTION POWER GAIN vs. FREQUENCY

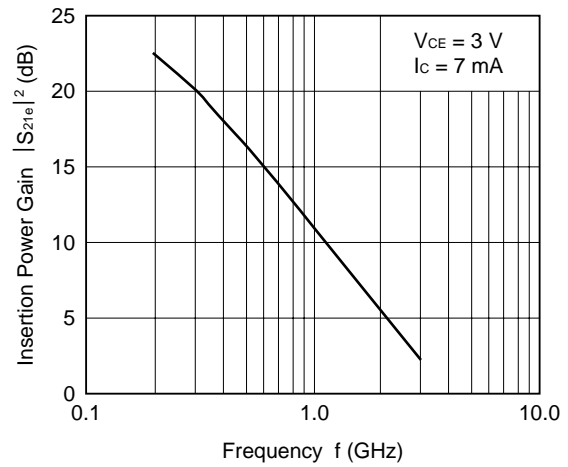

FEEDBACK CAPACITANCE vs. COLLECTOR TO BASE VOLTAGE

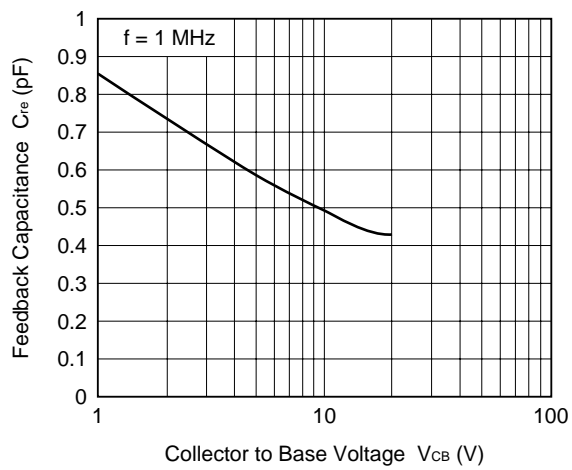

S-PARAMETERS Q1

V_{CE} = 3 V, I_c = 1 mA

FREQUENCY GHz	S ₁₁		S ₂₁		S ₁₂		S ₂₂	
	MAG.	ANG.	MAG.	ANG.	MAG.	ANG.	MAG.	ANG.
0.1	0.935	-30.6	4.001	157.5	0.033	52.0	0.979	-12.9
0.2	0.917	-58.7	3.602	137.5	0.082	54.2	0.938	-25.9
0.3	0.885	-83.8	3.244	119.5	0.109	38.9	0.894	-37.9
0.4	0.852	-107.8	2.910	101.9	0.129	21.3	0.834	-48.3
0.5	0.824	-128.9	2.622	86.4	0.140	6.9	0.785	-57.6
0.6	0.799	-148.1	2.351	71.6	0.149	-3.0	0.746	-66.3
0.7	0.781	-165.3	2.118	58.4	0.154	-15.2	0.708	-74.4
0.8	0.766	178.7	1.928	45.7	0.153	-24.2	0.680	-82.4
0.9	0.760	163.9	1.761	33.9	0.152	-34.4	0.662	-90.4
1.0	0.759	150.0	1.625	22.6	0.150	-42.1	0.647	-98.4
1.1	0.756	136.9	1.506	11.6	0.149	-51.0	0.633	-106.7
1.2	0.752	124.4	1.405	1.1	0.148	-58.9	0.620	-114.7
1.3	0.756	112.6	1.311	-9.2	0.141	-65.3	0.614	-123.0
1.4	0.755	100.9	1.233	-19.3	0.133	-72.1	0.605	-131.2
1.5	0.762	90.0	1.157	-29.1	0.129	-76.6	0.599	-139.6
1.6	0.764	79.3	1.094	-38.9	0.122	-84.1	0.593	-148.1
1.7	0.770	69.1	1.038	-48.3	0.119	-88.3	0.592	-157.1
1.8	0.771	58.7	0.981	-57.7	0.113	-91.8	0.589	-165.9
1.9	0.775	49.3	0.934	-66.4	0.105	-95.5	0.585	-174.6
2.0	0.780	39.4	0.885	-75.1	0.103	-96.9	0.585	176.4
2.1	0.783	29.9	0.846	-84.0	0.098	-99.6	0.585	167.0
2.2	0.787	20.9	0.803	-93.0	0.099	-101.5	0.580	157.7
2.3	0.791	11.9	0.770	-101.0	0.097	-100.6	0.580	147.9
2.4	0.790	2.8	0.732	-109.1	0.101	-101.3	0.581	138.2
2.5	0.790	-6.0	0.698	-116.8	0.106	-102.6	0.579	128.5
2.6	0.790	-14.2	0.669	-124.3	0.110	-104.2	0.580	118.5
2.7	0.791	-22.1	0.641	-131.7	0.116	-105.4	0.583	108.7
2.8	0.797	-30.1	0.619	-138.9	0.125	-109.3	0.584	98.7
2.9	0.804	-38.1	0.601	-146.4	0.133	-110.7	0.585	88.8
3.0	0.812	-46.0	0.574	-153.7	0.148	-117.1	0.590	78.7

V_{CE} = 3 V, I_c = 3 mA

FREQUENCY GHz	S ₁₁		S ₂₁		S ₁₂		S ₂₂	
	MAG.	ANG.	MAG.	ANG.	MAG.	ANG.	MAG.	ANG.
0.1	0.857	-42.7	9.861	150.3	0.038	65.3	0.945	-21.7
0.2	0.803	-78.7	8.253	127.1	0.072	39.2	0.826	-39.0
0.3	0.754	-108.0	6.931	107.8	0.087	27.5	0.719	-52.7
0.4	0.711	-133.4	5.798	90.7	0.093	18.6	0.622	-62.5
0.5	0.687	-154.4	4.995	76.6	0.103	7.4	0.555	-71.8
0.6	0.680	-172.0	4.317	63.2	0.110	-2.7	0.501	-79.9
0.7	0.663	172.2	3.797	51.6	0.104	-11.0	0.467	-87.0
0.8	0.658	157.8	3.376	40.7	0.110	-17.9	0.435	-93.9
0.9	0.658	144.8	3.038	30.1	0.109	-22.5	0.417	-101.6
1.0	0.656	132.2	2.769	20.0	0.108	-28.4	0.400	-108.5
1.1	0.663	120.8	2.543	10.1	0.111	-34.1	0.382	-116.4
1.2	0.658	109.9	2.347	0.6	0.112	-40.1	0.374	-123.9
1.3	0.670	99.2	2.178	-8.8	0.111	-44.2	0.364	-131.8
1.4	0.672	88.7	2.037	-18.0	0.110	-48.1	0.359	-139.7
1.5	0.679	79.0	1.906	-27.2	0.114	-52.5	0.350	-148.5
1.6	0.684	69.2	1.801	-36.4	0.118	-57.6	0.342	-156.6
1.7	0.690	60.0	1.702	-45.2	0.119	-61.6	0.339	-165.2
1.8	0.695	50.4	1.609	-53.9	0.121	-66.0	0.335	-173.8
1.9	0.700	41.6	1.524	-62.6	0.124	-70.1	0.331	177.1
2.0	0.701	32.5	1.448	-71.2	0.128	-74.6	0.329	168.2
2.1	0.711	23.4	1.384	-79.6	0.130	-79.2	0.328	159.0
2.2	0.713	14.9	1.314	-88.2	0.134	-82.6	0.324	149.8
2.3	0.723	6.6	1.261	-96.2	0.139	-86.5	0.323	139.7
2.4	0.725	-1.7	1.204	-104.4	0.146	-92.3	0.323	130.4
2.5	0.729	-10.3	1.151	-112.3	0.150	-96.8	0.324	119.9
2.6	0.732	-18.0	1.105	-120.1	0.158	-102.0	0.326	110.3
2.7	0.728	-25.4	1.067	-127.1	0.164	-106.7	0.329	100.2
2.8	0.739	-33.1	1.029	-135.4	0.171	-112.3	0.335	90.5
2.9	0.746	-40.7	1.004	-143.2	0.177	-116.4	0.337	80.2
3.0	0.756	-48.1	0.958	-150.7	0.186	-122.7	0.344	70.1

V_{CE} = 3 V, I_c = 5 mA

FREQUENCY GHz	S ₁₁		S ₂₁		S ₁₂		S ₂₂	
	MAG.	ANG.	MAG.	ANG.	MAG.	ANG.	MAG.	ANG.
0.1	0.783	-51.7	14.007	145.2	0.034	42.3	0.908	-27.8
0.2	0.723	-93.1	11.108	120.2	0.063	42.5	0.733	-46.9
0.3	0.685	-122.8	8.897	100.9	0.076	28.2	0.603	-61.7
0.4	0.650	-148.0	7.192	84.7	0.078	19.6	0.506	-71.0
0.5	0.641	-167.0	6.076	71.3	0.083	5.9	0.444	-80.2
0.6	0.621	175.9	5.181	59.2	0.086	4.9	0.390	-87.2
0.7	0.622	161.7	4.506	48.3	0.091	-3.0	0.359	-94.7
0.8	0.620	148.3	3.989	38.0	0.092	-7.8	0.333	-101.4
0.9	0.617	136.2	3.576	27.9	0.098	-15.3	0.310	-109.2
1.0	0.623	124.7	3.247	18.5	0.099	-19.1	0.299	-116.2
1.1	0.629	113.7	2.972	8.9	0.100	-24.7	0.282	-124.2
1.2	0.628	103.2	2.735	-0.2	0.107	-28.2	0.271	-131.4
1.3	0.639	93.3	2.537	-9.3	0.109	-35.2	0.264	-139.9
1.4	0.639	83.5	2.367	-18.0	0.113	-38.4	0.255	-146.9
1.5	0.648	74.2	2.209	-26.9	0.118	-43.5	0.248	-156.2
1.6	0.653	64.5	2.081	-35.8	0.122	-48.1	0.244	-164.9
1.7	0.661	55.7	1.970	-44.2	0.127	-51.6	0.242	-174.5
1.8	0.667	46.8	1.858	-53.2	0.130	-57.0	0.235	177.5
1.9	0.672	38.2	1.768	-61.3	0.135	-62.9	0.235	167.7
2.0	0.674	29.4	1.677	-69.7	0.143	-66.9	0.230	159.0
2.1	0.683	21.1	1.596	-78.1	0.145	-73.8	0.227	148.8
2.2	0.688	12.6	1.520	-86.7	0.153	-79.1	0.226	139.4
2.3	0.693	4.3	1.460	-94.5	0.158	-83.6	0.227	128.7
2.4	0.701	-3.8	1.393	-102.6	0.163	-89.5	0.229	118.7
2.5	0.704	-11.9	1.333	-110.3	0.170	-95.0	0.230	108.1
2.6	0.709	-20.2	1.273	-118.3	0.176	-100.3	0.232	98.2
2.7	0.707	-27.4	1.233	-125.5	0.184	-105.5	0.237	87.9
2.8	0.716	-34.6	1.194	-133.2	0.191	-111.8	0.244	78.2
2.9	0.724	-42.3	1.158	-141.0	0.197	-117.8	0.250	68.2
3.0	0.731	-49.5	1.113	-148.6	0.204	-123.7	0.257	57.8

V_{CE} = 3 V, I_c = 7 mA

FREQUENCY GHz	S ₁₁		S ₂₁		S ₁₂		S ₂₂	
	MAG.	ANG.	MAG.	ANG.	MAG.	ANG.	MAG.	ANG.
0.1	0.757	-59.4	17.566	141.1	0.052	28.0	0.894	-32.9
0.2	0.674	-105.0	13.237	114.8	0.055	39.5	0.660	-54.2
0.3	0.636	-134.6	10.240	96.1	0.065	26.5	0.528	-68.3
0.4	0.605	-159.0	8.099	80.8	0.067	19.9	0.429	-78.4
0.5	0.604	-176.4	6.754	67.9	0.073	13.9	0.363	-86.8
0.6	0.599	167.7	5.730	56.5	0.079	6.6	0.320	-93.8
0.7	0.593	154.1	4.957	46.0	0.078	4.0	0.287	-100.9
0.8	0.599	141.8	4.368	36.2	0.085	-4.0	0.265	-108.5
0.9	0.600	130.4	3.911	26.6	0.092	-7.4	0.247	-115.7
1.0	0.600	119.6	3.542	17.4	0.093	-11.2	0.232	-122.7
1.1	0.610	109.2	3.242	8.1	0.099	-16.7	0.220	-131.6
1.2	0.611	99.1	2.985	-0.8	0.103	-21.9	0.211	-138.9
1.3	0.619	89.4	2.757	-9.5	0.111	-27.5	0.205	-147.6
1.4	0.624	80.2	2.580	-18.2	0.116	-31.0	0.198	-156.5
1.5	0.632	71.0	2.411	-27.0	0.121	-36.4	0.193	-165.6
1.6	0.637	61.9	2.264	-35.5	0.128	-43.4	0.185	-174.8
1.7	0.644	53.4	2.144	-44.0	0.133	-47.9	0.186	175.7
1.8	0.650	44.4	2.018	-52.7	0.137	-53.5	0.179	167.3
1.9	0.659	36.1	1.913	-60.5	0.143	-58.8	0.180	156.3
2.0	0.659	27.4	1.816	-69.1	0.151	-64.1	0.176	147.7
2.1	0.669	18.9	1.732	-77.2	0.156	-70.6	0.176	136.8
2.2	0.674	10.8	1.646	-85.6	0.162	-76.7	0.178	126.0
2.3	0.679	2.8	1.579	-93.6	0.167	-81.9	0.178	115.3
2.4	0.685	-5.2	1.510	-101.3	0.174	-88.1	0.180	104.9
2.5	0.693	-13.3	1.448	-109.2	0.181	-94.5	0.183	94.2
2.6	0.696	-21.3	1.387	-117.1	0.186	-100.3	0.187	83.6
2.7	0.695	-28.2	1.342	-124.0	0.195	-105.7	0.192	74.2
2.8	0.701	-35.7	1.296	-132.0	0.202	-112.5	0.201	65.5
2.9	0.709	-43.1	1.256	-139.8	0.208	-118.0	0.207	54.1
3.0	0.719	-50.4	1.208	-147.4	0.214	-124.3	0.218	44.5

S-PARAMETERS Q2

V_{CE} = 3 V, I_c = 1 mA

FREQUENCY GHz	S ₁₁		S ₂₁		S ₁₂		S ₂₂	
	MAG.	ANG.	MAG.	ANG.	MAG.	ANG.	MAG.	ANG.
0.1	0.940	-31.2	3.801	156.2	0.043	43.7	1.001	-13.7
0.2	0.918	-58.6	3.406	136.0	0.083	51.6	0.942	-27.2
0.3	0.871	-83.6	3.051	117.4	0.107	36.1	0.888	-38.6
0.4	0.831	-107.6	2.711	99.6	0.124	19.3	0.838	-48.9
0.5	0.807	-128.4	2.453	83.9	0.135	7.3	0.791	-58.6
0.6	0.779	-146.8	2.184	69.7	0.142	-2.1	0.753	-67.3
0.7	0.759	-164.1	1.971	55.9	0.147	-16.0	0.727	-76.1
0.8	0.746	-179.3	1.802	43.7	0.146	-23.4	0.697	-84.5
0.9	0.736	166.5	1.651	32.0	0.147	-32.1	0.681	-92.9
1.0	0.731	153.2	1.526	20.5	0.140	-39.8	0.667	-101.0
1.1	0.723	140.5	1.414	9.4	0.137	-48.4	0.658	-109.8
1.2	0.722	128.7	1.327	-1.1	0.133	-54.4	0.643	-118.1
1.3	0.722	116.7	1.242	-11.2	0.127	-60.2	0.641	-126.8
1.4	0.721	105.8	1.177	-21.2	0.123	-65.3	0.634	-135.6
1.5	0.727	95.2	1.116	-30.9	0.118	-69.9	0.626	-144.6
1.6	0.725	84.2	1.056	-40.9	0.114	-73.0	0.622	-153.5
1.7	0.725	74.3	1.005	-49.9	0.110	-75.5	0.619	-162.7
1.8	0.726	64.0	0.956	-59.5	0.105	-77.3	0.615	-172.1
1.9	0.730	54.7	0.918	-68.0	0.109	-77.4	0.611	178.5
2.0	0.728	44.5	0.878	-76.9	0.110	-76.3	0.608	169.1
2.1	0.733	35.2	0.841	-85.5	0.111	-77.9	0.606	159.3
2.2	0.730	25.8	0.807	-94.4	0.120	-79.5	0.602	149.3
2.3	0.731	16.5	0.781	-102.3	0.128	-80.0	0.598	139.2
2.4	0.734	7.4	0.750	-110.4	0.141	-82.6	0.590	129.1
2.5	0.733	-1.2	0.724	-118.2	0.156	-87.3	0.586	119.0
2.6	0.738	-10.2	0.698	-125.9	0.170	-92.0	0.574	109.6
2.7	0.740	-19.0	0.671	-133.2	0.184	-96.9	0.572	100.7
2.8	0.741	-27.9	0.652	-140.1	0.193	-101.9	0.584	91.3
2.9	0.736	-36.5	0.639	-147.2	0.214	-106.9	0.589	81.0
3.0	0.736	-44.7	0.619	-154.0	0.236	-112.4	0.594	70.3

V_{CE} = 3 V, I_c = 3 mA

FREQUENCY GHz	S ₁₁		S ₂₁		S ₁₂		S ₂₂	
	MAG.	ANG.	MAG.	ANG.	MAG.	ANG.	MAG.	ANG.
0.1	0.859	-41.8	9.399	149.0	0.040	52.8	0.952	-21.0
0.2	0.786	-78.1	7.841	125.3	0.072	43.0	0.828	-38.2
0.3	0.730	-106.6	6.534	105.8	0.085	28.3	0.721	-51.8
0.4	0.681	-131.0	5.449	88.9	0.093	16.7	0.631	-61.4
0.5	0.645	-151.5	4.687	74.3	0.096	9.5	0.568	-69.9
0.6	0.630	-168.6	4.043	61.3	0.100	1.8	0.519	-77.6
0.7	0.615	176.0	3.570	49.7	0.109	-6.0	0.488	-85.1
0.8	0.607	161.8	3.179	38.5	0.108	-12.5	0.466	-92.2
0.9	0.604	149.3	2.862	27.9	0.110	-17.2	0.445	-99.8
1.0	0.598	137.2	2.618	17.6	0.112	-23.3	0.431	-107.7
1.1	0.598	126.1	2.413	7.8	0.114	-27.9	0.413	-115.7
1.2	0.598	114.8	2.233	-2.0	0.117	-32.0	0.405	-123.2
1.3	0.599	104.9	2.088	-11.2	0.122	-36.9	0.398	-131.5
1.4	0.598	94.7	1.956	-20.5	0.125	-41.1	0.394	-139.5
1.5	0.604	84.9	1.838	-29.8	0.129	-44.7	0.386	-148.1
1.6	0.604	75.1	1.744	-39.0	0.133	-48.5	0.378	-157.0
1.7	0.610	66.0	1.658	-48.0	0.139	-53.2	0.376	-165.8
1.8	0.609	56.6	1.573	-56.8	0.144	-57.0	0.370	-174.4
1.9	0.613	47.8	1.512	-65.5	0.154	-63.1	0.366	176.1
2.0	0.613	38.9	1.438	-74.1	0.160	-65.5	0.364	167.7
2.1	0.618	29.9	1.386	-82.8	0.169	-72.3	0.359	158.0
2.2	0.617	21.1	1.328	-91.6	0.178	-77.2	0.356	148.6
2.3	0.624	12.6	1.280	-100.0	0.188	-82.0	0.352	138.5
2.4	0.622	4.1	1.231	-108.2	0.199	-87.0	0.349	128.5
2.5	0.626	-4.5	1.186	-116.2	0.211	-93.2	0.345	118.4
2.6	0.635	-13.0	1.144	-124.7	0.221	-99.9	0.337	109.3
2.7	0.638	-21.2	1.105	-132.1	0.232	-106.5	0.337	101.0
2.8	0.635	-29.4	1.072	-139.7	0.241	-112.0	0.347	91.9
2.9	0.635	-37.6	1.045	-147.6	0.251	-118.3	0.352	81.5
3.0	0.639	-45.6	1.023	-155.3	0.265	-124.6	0.355	71.2

V_{CE} = 3 V, I_c = 5 mA

FREQUENCY GHz	S ₁₁		S ₂₁		S ₁₂		S ₂₂	
	MAG.	ANG.	MAG.	ANG.	MAG.	ANG.	MAG.	ANG.
0.1	0.781	-51.3	14.135	143.2	0.051	51.1	0.894	-27.2
0.2	0.688	-93.4	10.958	117.3	0.064	43.0	0.722	-46.9
0.3	0.637	-122.8	8.655	98.1	0.068	28.4	0.594	-60.1
0.4	0.592	-146.1	6.978	82.3	0.076	20.3	0.500	-69.4
0.5	0.572	-165.5	5.847	68.7	0.080	14.1	0.435	-77.1
0.6	0.556	178.5	4.984	56.8	0.084	11.2	0.395	-83.4
0.7	0.545	164.5	4.330	45.6	0.091	4.9	0.364	-89.8
0.8	0.542	151.4	3.848	35.6	0.097	-3.9	0.345	-97.3
0.9	0.541	139.6	3.453	25.6	0.099	-6.8	0.329	-104.1
1.0	0.541	128.6	3.142	15.8	0.108	-11.6	0.315	-111.6
1.1	0.542	118.3	2.886	6.4	0.114	-15.6	0.301	-119.0
1.2	0.541	107.9	2.666	-2.8	0.119	-22.1	0.294	-127.0
1.3	0.547	98.4	2.476	-12.0	0.128	-25.6	0.289	-134.9
1.4	0.548	88.5	2.321	-20.8	0.133	-31.5	0.279	-142.5
1.5	0.551	79.8	2.184	-29.7	0.140	-36.8	0.272	-151.2
1.6	0.554	70.5	2.067	-38.6	0.149	-41.8	0.268	-159.4
1.7	0.557	61.4	1.959	-47.3	0.157	-47.1	0.264	-169.4
1.8	0.561	52.5	1.856	-56.2	0.167	-52.5	0.258	-177.0
1.9	0.563	44.2	1.783	-64.5	0.173	-58.1	0.256	172.7
2.0	0.564	35.5	1.698	-73.1	0.183	-63.6	0.253	164.0
2.1	0.571	26.9	1.630	-81.6	0.192	-70.6	0.247	154.6
2.2	0.572	18.4	1.566	-90.3	0.204	-76.0	0.245	144.2
2.3	0.573	10.1	1.510	-98.3	0.213	-82.0	0.240	134.3
2.4	0.575	2.0	1.454	-106.6	0.226	-89.0	0.240	124.5
2.5	0.578	-6.3	1.407	-114.8	0.236	-95.5	0.234	113.3
2.6	0.585	-14.4	1.351	-123.1	0.248	-102.1	0.226	104.2
2.7	0.589	-22.7	1.303	-130.6	0.254	-108.9	0.222	96.8
2.8	0.591	-30.9	1.273	-138.3	0.263	-115.2	0.236	88.4
2.9	0.589	-39.0	1.240	-146.2	0.274	-121.3	0.242	77.7
3.0	0.594	-46.6	1.204	-153.9	0.287	-127.5	0.247	66.9

V_{CE} = 3 V, I_c = 7 mA

FREQUENCY GHz	S ₁₁		S ₂₁		S ₁₂		S ₂₂	
	MAG.	ANG.	MAG.	ANG.	MAG.	ANG.	MAG.	ANG.
0.1	0.716	-59.5	17.531	138.7	0.041	39.9	0.858	-33.8
0.2	0.624	-104.0	12.884	112.1	0.056	44.5	0.646	-53.1
0.3	0.565	-133.6	9.834	93.5	0.059	35.1	0.513	-65.0
0.4	0.540	-156.9	7.746	78.3	0.066	22.5	0.421	-73.6
0.5	0.522	-173.9	6.422	65.9	0.071	19.6	0.367	-80.3
0.6	0.516	170.6	5.451	54.8	0.080	15.8	0.331	-87.4
0.7	0.516	157.5	4.723	44.0	0.084	7.2	0.301	-93.6
0.8	0.515	145.5	4.200	33.9	0.091	3.9	0.280	-99.5
0.9	0.512	134.4	3.754	24.3	0.100	-0.4	0.267	-107.3
1.0	0.515	124.0	3.404	15.0	0.108	-4.6	0.255	-114.1
1.1	0.518	113.5	3.124	5.7	0.116	-10.2	0.243	-121.6
1.2	0.516	104.0	2.875	-3.4	0.124	-16.1	0.233	-129.8
1.3	0.522	95.0	2.683	-12.1	0.132	-20.6	0.228	-138.1
1.4	0.520	85.4	2.510	-20.9	0.140	-26.7	0.219	-146.0
1.5	0.527	76.6	2.361	-29.9	0.150	-32.7	0.216	-155.1
1.6	0.531	67.8	2.221	-38.6	0.159	-39.1	0.209	-163.4
1.7	0.532	59.2	2.111	-47.1	0.169	-44.3	0.209	-172.8
1.8	0.536	50.4	2.004	-55.6	0.178	-49.6	0.201	179.6
1.9	0.537	42.2	1.916	-64.1	0.187	-56.4	0.199	169.0
2.0	0.542	33.1	1.829	-72.5	0.196	-62.8	0.194	160.6
2.1	0.546	25.1	1.757	-80.8	0.206	-69.4	0.191	151.0
2.2	0.551	16.6	1.684	-89.5	0.217	-75.6	0.188	140.7
2.3	0.553	8.9	1.623	-97.4	0.227	-82.7	0.185	130.1
2.4	0.553	0.7	1.563	-105.7	0.237	-88.8	0.185	119.5
2.5	0.559	-7.5	1.515	-113.9	0.251	-95.8	0.181	108.6
2.6	0.566	-15.6	1.455	-122.3	0.259	-102.7	0.173	97.9
2.7	0.569	-23.8	1.399	-129.7	0.265	-110.4	0.171	91.3
2.8	0.567	-31.7	1.368	-137.4	0.276	-116.8	0.183	83.4
2.9	0.568	-39.8	1.337	-145.1	0.286	-122.5	0.188	71.9
3.0	0.571	-47.4	1.301	-153.0	0.298	-129.1	0.194	61.8

PACKAGE DIMENSIONS

FLAT-LEAD 6 PIN THIN-TYPE ULTRA SUPER MINIMOLD (UNIT: mm)

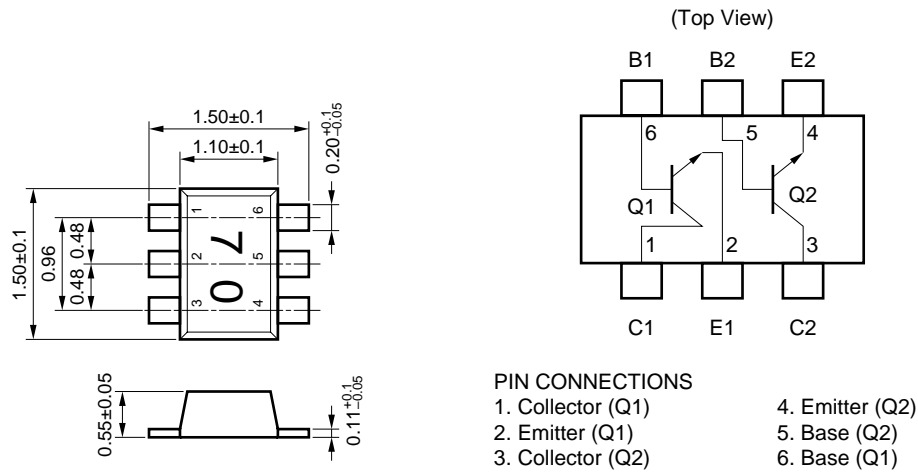

[MEMO]

[MEMO]

- **The information in this document is subject to change without notice. Before using this document, please confirm that this is the latest version.**
 - No part of this document may be copied or reproduced in any form or by any means without the prior written consent of NEC Corporation. NEC Corporation assumes no responsibility for any errors which may appear in this document.
 - NEC Corporation does not assume any liability for infringement of patents, copyrights or other intellectual property rights of third parties by or arising from use of a device described herein or any other liability arising from use of such device. No license, either express, implied or otherwise, is granted under any patents, copyrights or other intellectual property rights of NEC Corporation or others.
 - Descriptions of circuits, software, and other related information in this document are provided for illustrative purposes in semiconductor product operation and application examples. The incorporation of these circuits, software, and information in the design of the customer's equipment shall be done under the full responsibility of the customer. NEC Corporation assumes no responsibility for any losses incurred by the customer or third parties arising from the use of these circuits, software, and information.
 - While NEC Corporation has been making continuous effort to enhance the reliability of its semiconductor devices, the possibility of defects cannot be eliminated entirely. To minimize risks of damage or injury to persons or property arising from a defect in an NEC semiconductor device, customers must incorporate sufficient safety measures in its design, such as redundancy, fire-containment, and anti-failure features.
 - NEC devices are classified into the following three quality grades:
"Standard", "Special", and "Specific". The Specific quality grade applies only to devices developed based on a customer designated "quality assurance program" for a specific application. The recommended applications of a device depend on its quality grade, as indicated below. Customers must check the quality grade of each device before using it in a particular application.
 - Standard: Computers, office equipment, communications equipment, test and measurement equipment, audio and visual equipment, home electronic appliances, machine tools, personal electronic equipment and industrial robots
 - Special: Transportation equipment (automobiles, trains, ships, etc.), traffic control systems, anti-disaster systems, anti-crime systems, safety equipment and medical equipment (not specifically designed for life support)
 - Specific: Aircraft, aerospace equipment, submersible repeaters, nuclear reactor control systems, life support systems or medical equipment for life support, etc.
- The quality grade of NEC devices is "Standard" unless otherwise specified in NEC's Data Sheets or Data Books. If customers intend to use NEC devices for applications other than those specified for Standard quality grade, they should contact an NEC sales representative in advance.