



UM82C284-10/-12

Clock Generator and Ready Interface

Features

- Generates system clock for 80286 processors
- Uses crystal or TTL signal for frequency source
- Provides local READY and Multibus* READY synchronization
- Single +5V power supply
- Generates system reset output from Schmitt Trigger input
- 10 MHz and 12.5 MHz versions

General Description

UM82C284-10/12 is a clock generator/driver which provides clock signals for 80286 processors and support components. It also contains logic to supply READY to the

CPU from either asynchronous or synchronous sources and synchronous RESET from an asynchronous input with hysteresis. It is fabricated using the Si-Gate CMOS process.

Pin Configuration

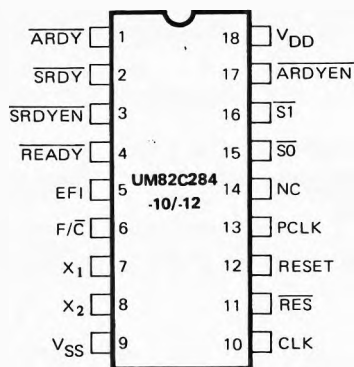

* Multibus is an Intel Trademark

Block Diagram

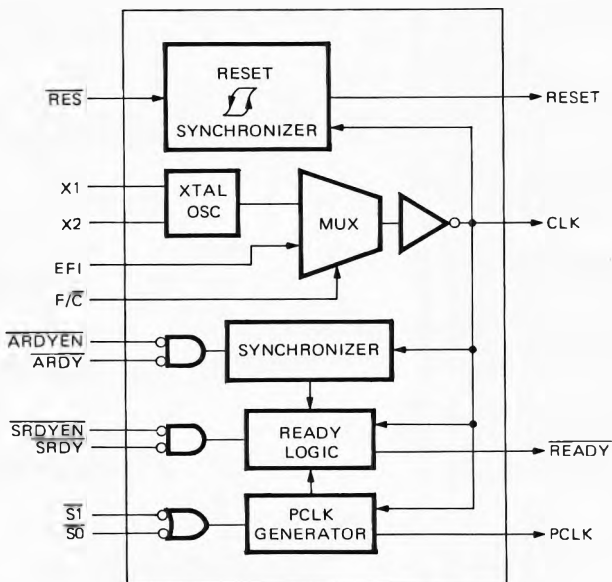

Absolute Maximum Ratings*

Temperature Under Bias	0°C to 70°C
Storage Temperature	-65°C to +150°C
All Output and Supply Voltages	-0.5V to +7V
All Input Voltages	-1.0V to +5.5V
Power Dissipation	1 Watt

***Comments**

Stresses above those listed under "Absolute Maximum Ratings" may cause permanent damage to the device. These are stress ratings only. Functional operation of this device at these or any other conditions above those indicated in the operational sections of this specification is not implied and exposure to absolute maximum rating conditions for extended periods may affect device reliability.

Pin Description

Symbol	I/O	Description
CLK	O	System Clock is the signal used by the processor and support devices which must be synchronous with the processor. The frequency of the CLK output is twice the desired internal processor clock frequency. CLK can drive both TTL and MOS level inputs.
F/C	I	Frequency/Crystal Select is a strapping option to select the source for the CLK output. When F/C is strapped LOW, the internal crystal oscillator drives CLK. When F/C is strapped HIGH, the EFI input drives the CLK output.
X1, X2	I	Crystal In are the pins to which a parallel resonant fundamental mode crystal is attached for the internal oscillator. When F/C is LOW, the internal oscillator will drive the CLK output at the crystal frequency. The crystal frequency must be twice the desired internal processor clock frequency.
EFI	I	External Frequency In drives CLK when the F/C input is strapped HIGH. The EFI input frequency must be twice the desired internal processor clock frequency.
PCLK	O	Peripheral Clock is an output which provides a 50% duty cycle clock with 1/2 the frequency of CLK. PCLK will be in phase with the internal processor clock following the first bus cycle after the processor has been reset.
ARDYEN	I	Asynchronous Ready Enable is an active LOW input which qualifies the ARDY input. ARDYEN selects ARDY as the source of ready for the current bus cycle. Inputs to ARDYEN may be applied asynchronously to CLK. Setup and hold times are given to assure a guaranteed response to synchronous inputs.
ARDY	I	Asynchronous Ready is an active LOW input used to terminate the current bus cycle. The ARDY input is qualified by ARDYEN. Inputs to ARDY may be applied asynchronously to CLK. Setup and hold times are given to assure a guaranteed response to synchronous inputs.
SRDYEN	I	Synchronous Ready Enable is an active LOW input which qualifies SRDY. SRDYEN selects SRDY as the source for READY to the CPU for the current bus cycle. Setup and hold times must be satisfied for proper operation.
SRDY	I	Synchronous Ready is an active LOW input used to terminate the current bus cycle. The SRDY input is qualified by the SRDYEN input. Setup and hold times must be satisfied for proper operation.
READY	O	Ready is an active LOW output which signals that the current bus cycle is to be completed. The SRDY, SRDYEN, ARDY, ARDYEN, S1, S0 and RES inputs which control READY are explained later in the READY generator section. READY is an open collector output requiring an external 300 ohm pullup resistor.
S0, S1	I	Status inputs prepare the UM82C284-10/-12 for a subsequent bus cycle. S0 and S1 synchronize PCLK to the internal processor clock and control READY. These inputs have pullup resistors to keep them HIGH if nothing is driving them. Setup and hold times must be satisfied for proper operation.
RESET	O	Reset is an active HIGH output which is derived from the RES input. RESET is used to force the system into an initial state. When RESET is active, READY will be active (LOW).
RES	I	Reset In is an active LOW input which generates the system reset signal, RESET. Signals to RES may be applied asynchronously to CLK. A Schmitt trigger input is provided on RES, so that an RC circuit can be used to provide a time delay. Setup and hold times are given to assure a guaranteed response to synchronous inputs.
V _{DD}		System Power: +5V power supply.
V _{SS}		System Ground: 0 volts.

Functional Description

Introduction

The UM82C284-10/-12 generates the clock, ready, and reset signals required for 80286 processors and support components. The UM82C284-10/-12 is packaged in an 18-pin DIP and contains a crystal controlled oscillator, MOS clock generator, peripheral clock generator, Multibus ready synchronization logic and system reset generation logic.

Clock Generator

The CLK output provides the basic timing control for an 80286 system. CLK has output characteristics sufficient to drive MOS devices. CLK is generated by either an internal crystal oscillator or an external source as selected by the F/\overline{C} strapping option. When F/\overline{C} is LOW, the crystal oscillator drives the CLK output. When F/\overline{C} is HIGH, the $E\overline{F}1$ input drives the CLK output.

The UM82C284-10/-12 provides a second clock output (PCLK) for peripheral devices. PCLK is CLK divided by two. PCLK has a duty cycle of 50% and TTL-output drive characteristics. PCLK is normally synchronized to the internal processor clock.

After reset, the PCLK signal may be out of phase with the internal processor clock. The $\overline{S}1$ and $\overline{S}0$ signals of the first bus cycle are used to synchronize PCLK to the internal processor clock. The phase of the PCLK output changes by extending its HIGH time beyond one system clock (see waveforms). PCLK is forced HIGH whenever either $\overline{S}0$ or $\overline{S}1$ were active (LOW) for the two previous CLK cycles. PCLK continues to oscillate when both $\overline{S}0$ and $\overline{S}1$ are HIGH.

Since the phase of the internal processor clock will not change, except during reset, the phase of PCLK will not change, except during the first bus cycle after reset.

Oscillator

The oscillator circuit of the UM82C284-10/-12 is a linear Pierce Oscillator which requires an external parallel resonant, fundamental mode & crystal. The output of the oscillator is internally buffered. The crystal frequency chosen should be twice the required internal processor clock frequency. The crystal should have a typical load capacitance of 32 pF.

X1 and X2 are the oscillator crystal connections. For stable operation of the oscillator, two loading capacitors are recommended, as shown in Figure 1. The sum of the board capacitance and loading capacitance should equal the values shown. It is advisable to limit stray board capacitances (not including the effect of the loading capacitors or crystal capacitance) to less than 10 pF between the X1 and X2 pins. Decouple V_{DD} and V_{SS} as close to the UM82C284/-10/-12 as possible.

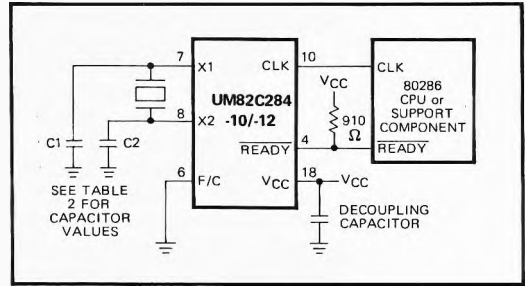

Figure 1. Recommended Crystal and READY Connections

Reset Operation

The reset logic provides the RESET output to force the system into a known, initial state. When the \overline{RES} input is active (LOW), the RESET output becomes active (HIGH). \overline{RES} is synchronized internally at the falling edge of CLK before generating the RESET output (see waveforms). Synchronization of the \overline{RES} input introduces a one or two CLK delay before affecting the RESET output.

At power up, a system does not have a stable V_{DD} and CLK. To prevent spurious activity, \overline{RES} should be asserted until V_{CC} and CLK stabilize at their operating values. 80286 processors and support components also require their RESET inputs to be HIGH a minimum of 16 CLK cycles. An RC network, as shown in Figure 2, will keep \overline{RES} LOW long enough to satisfy both needs.

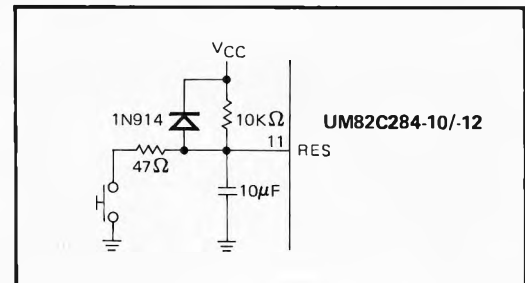

Figure 2. Typical RC \overline{RES} Timing Circuit

A Schmitt Trigger input with hysteresis on \overline{RES} assures a single transition of RESET with an RC circuit on \overline{RES} . The hysteresis separates the input voltage level at which the circuit output switches from HIGH to LOW from the input voltage level at which the circuit output switches from LOW to HIGH. The \overline{RES} HIGH to LOW input transition voltage is lower than the \overline{RES} LOW to HIGH input transition voltage. As long as the slope of the \overline{RES}

input voltage remains in the same direction (increasing or decreasing) around the $\overline{\text{RES}}$ input transition voltage, the RESET output will make a single transition.

Ready Operation

The UM82C284-10/-12 accepts two ready sources for the system ready signal which terminates the current bus cycle. Either a synchronous ($\overline{\text{SRDY}}$) or asynchronous ready ($\overline{\text{ARDY}}$) source may be used. Each ready input has an enable ($\overline{\text{SRDYEN}}$ and $\overline{\text{ARDYEN}}$) for selecting the type of ready source required to terminate the current bus cycle. An address decoder would normally select one of the enable inputs.

$\overline{\text{READY}}$ is enabled (LOW), if either $\overline{\text{SRDY}} + \overline{\text{SRDYEN}} = "0"$ or $\overline{\text{ARDY}} + \overline{\text{ARDYEN}} = "0"$ when sampled by the UM82C284-10/-12 $\overline{\text{READY}}$ generation logic. $\overline{\text{READY}}$ will remain active for at least two CLK cycles.

The $\overline{\text{READY}}$ output has an open-collector driver allowing other ready circuits to be wire-ORed with it, as shown in Figure 1. The $\overline{\text{READY}}$ signal of an 80286 system requires an external 910 ohm $\pm 5\%$ pull-up resistor. To

force the $\overline{\text{READY}}$ signal inactive (HIGH) at the start of a bus cycle, the $\overline{\text{READY}}$ output floats when either $\overline{\text{S1}}$ or $\overline{\text{S0}}$ are sampled LOW at the falling edge of CLK. Two system clock periods are allowed for the pull-up resistor to pull the $\overline{\text{READY}}$ signal to V_{IH} . When RESET is active, $\overline{\text{READY}}$ is forced active one CLK later (see waveforms).

Figure 3 illustrates the operation of $\overline{\text{SRDY}}$ and $\overline{\text{SRDYEN}}$. These inputs are sampled on the falling edge of CLK when $\overline{\text{S1}}$ and $\overline{\text{S0}}$ are inactive and PCLK is HIGH. $\overline{\text{READY}}$ is forced active when both $\overline{\text{SRDY}}$ and $\overline{\text{SRDYEN}}$ are sampled as LOW.

Figure 4 shows the operation of $\overline{\text{ARDY}}$ and $\overline{\text{ARDYEN}}$. These inputs are sampled by an internal synchronizer at each falling edge of CLK. The output of the synchronizer is then sampled when PCLK is HIGH. If the synchronizer finds both the $\overline{\text{ARDY}}$ and $\overline{\text{ARDYEN}}$ have been resolved as active, the $\overline{\text{SRDY}}$ and $\overline{\text{SRDYEN}}$ inputs are ignored. Either $\overline{\text{ARDY}}$ or $\overline{\text{ARDYEN}}$ must be HIGH at the end of T_s (see figure 4).

$\overline{\text{READY}}$ remains active until either $\overline{\text{S1}}$ or $\overline{\text{S0}}$ are sampled LOW, or the ready inputs are sampled as inactive.

Table 2. UM82C284-10/-12 Crystal Loading Capacitance Values

Crystal Frequency	C1 Capacitance (pin 7)	C2 Capacitance (pin 8)
1 to 8 MHz	60 pF	40 pF
8 to 25 MHz	25 pF	15 pF

Note: Capacitance values must include stray board capacitance.

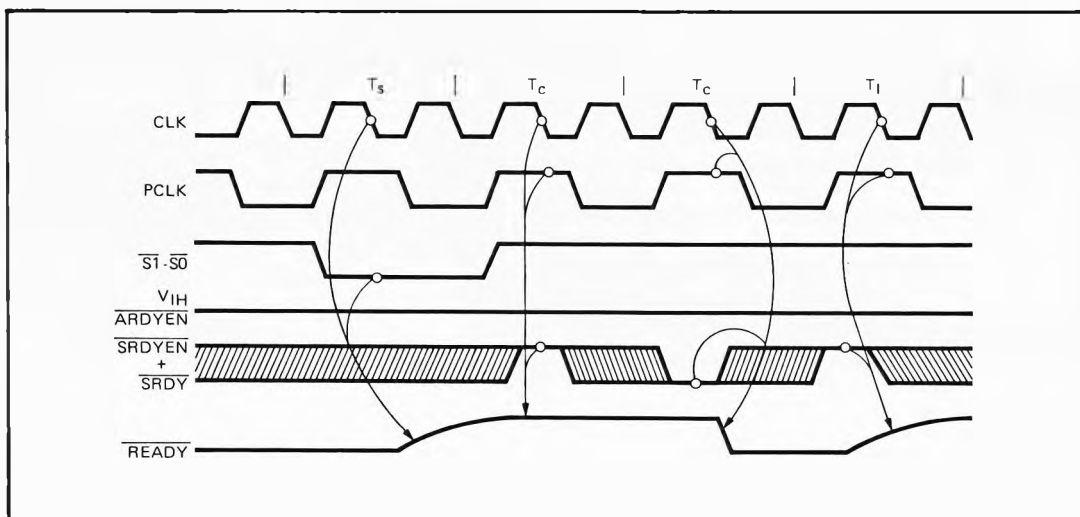
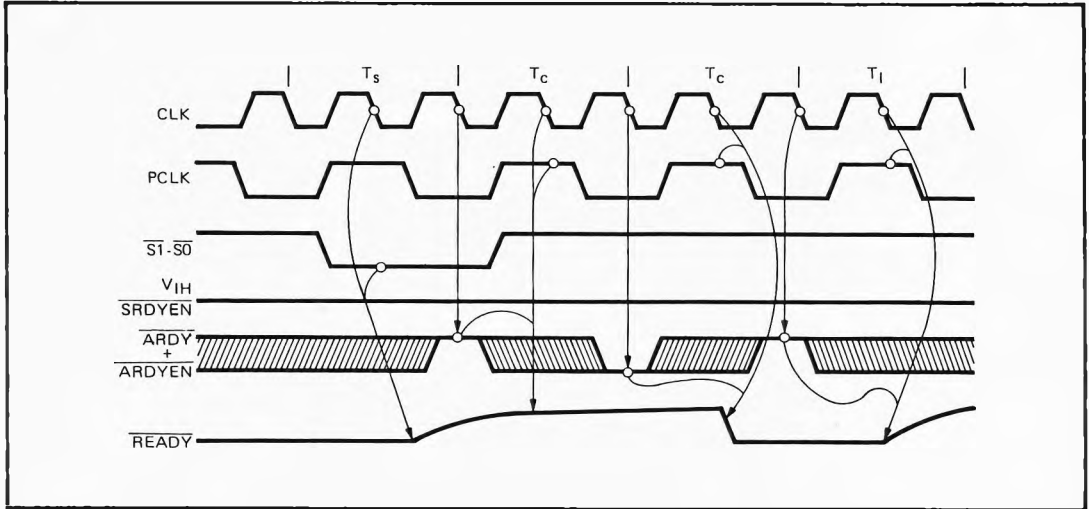

Figure 3. Synchronous Ready Operation

Figure 4. Asynchronous Ready Operation
D.C. Electrical Characteristics
 $(T_A = 0^{\circ}\text{C to } 70^{\circ}\text{C}, V_{DD} = 5\text{V}, \pm 10\%)$

Symbol	Parameter	10 MHz		12.5 MHz		Unit	Test Condition
		Min.	Max.	Min.	Max.		
V_{IL}	Input LOW Voltage		0.8		0.8	V	
V_{IH}	Input HIGH Voltage	2.0		2.0		V	
V_{IHR}	$\overline{\text{RES}}$ and EFI Input HIGH Voltage	2.6		2.6		V	
V_{HYS}	$\overline{\text{RES}}$ Input Hysteresis	0.25		0.25		V	
V_{OL}	RESET, PCLK Output LOW Voltage		0.45		0.45	V	$I_{OL} = 5\text{ mA}$
V_{OH}	RESET, PCLK Output HIGH Voltage	2.4		2.4		V	$I_{OH} = -1\text{ mA}$
V_{OLR}	$\overline{\text{READY}}$, Output LOW Voltage		0.45		0.45	V	$I_{OL} = 9\text{ mA}$
V_{OLC}	CLK Output LOW Voltage		0.45		0.45	V	$I_{OL} = 5\text{ mA}$
V_{OHC}	CLK Output HIGH Voltage	4.0		4.0		V	$I_{OH} = -800\mu\text{A}$
I_{CC}	Power Supply Current		75.0		75.0	mA	at 25 MHz Output CLK Frequency
I_{LI}	Input Leakage Current		± 10.0		± 10.0	μA	$0 \leq V_{IN} \leq V_{CC}$
C_I	Input Capacitance		10.0		10.0	pF	$F_C = 1\text{ MHz}$

A.C. Characteristics
 $(T_A = 0^{\circ}\text{C to } 70^{\circ}\text{C}, V_{DD} = 5\text{V}, \pm 10\%)$

AC timings are referenced to 0.8V and 2.0V points of signals as illustrated in data sheet waveforms, unless otherwise noted.

Symbol	Parameter	10 MHz		12.5 MHz		Unit	Test Condition
		Min.	Max.	Min.	Max.		
1	EFI to CLK Delay		25		25	ns	at 1.5V Note 1
2	EFI LOW Time	22.5		14		ns	at 0.8V Note 1
3	EFI HIGH Time	22.5		22		ns	at 2.0V Note 1
4	CLK Period	50	500	40	500	ns	
5	CLK LOW Time	12		11		ns	at 0.6V Note 1, Note 2
6	CLK HIGH Time	16		13		ns	at 3.8V Note 1, Note 2
7	CLK Rise Time		8		8	ns	1.0V to 3.5V Note 1
8	CLK Fall Time		8		8	ns	3.5 V to 1.0V Note 1
9	Status Setup Time for Status Going Active	20		22		ns	Note 1
	Status Setup Time for Status Going Inactive	20		20			
10	Status Hold Time	1		3		ns	Note 1
11	$\overline{\text{SRDY}}$ or $\overline{\text{SRDYEN}}$ Setup Time	15		15		ns	Note 1
12	$\overline{\text{SRDY}}$ or $\overline{\text{SRDYEN}}$ Hold Time	2		2		ns	Note 1
13	$\overline{\text{ARDY}}$ or $\overline{\text{ARDYEN}}$ Setup Time	0		0		ns	Note 1, Note 3
14	$\overline{\text{ARDY}}$ or $\overline{\text{ARDYEN}}$ Hold Time	30		25		ns	Note 1, Note 3
15	$\overline{\text{RES}}$ Setup Time	20		18		ns	Note 1, Note 3
16	$\overline{\text{RES}}$ Hold Time	10		8		ns	Note 1, Note 3
17	$\overline{\text{READY}}$ Active Delay	5		5		ns	at 0.8V Note 4
18	$\overline{\text{READY}}$ Active Delay	0	24	0	18	ns	at 0.8V Note 4
19	PCLK Delay	0	35	0	23	ns	Note 5
20	RESET Delay	5	27	3	22	ns	Note 5
21	PCLK LOW Time	t4-20		t4-20		ns	Note 5, Note 6
22	PCLK HIGH Time	t4-20		t4-20		ns	Note 5, Note 6

 Note 1: CLK Loading: $C_L = 100\text{pF}$.

 Note 2: With the internal crystal oscillator using recommended crystal and capacitive loading, or with the EFI input meeting specifications t2, and t3. Use a parallel-resonant, fundamental mode crystal. The recommended crystal loading for CLK frequencies of 8-25 MHz are 25pF from pin X₁ to ground, and 15pF from pin X₂ to ground. These recommended values are $\pm 5\text{pF}$ and include all stray capacitance. Decouple V_{DD} and V_{SS} as close to the UM82C284-10/-12 as possible.

Note 3: This is an asynchronous input. This specification is given for testing purposes only, to assure recognition at specific CLK edge.

 Note 4: $\overline{\text{READY}}$ loading: $I_{OL} = 7\text{ mA}$, $C_L = 150\text{pF}$. In system application, use 910 ohm $\pm 5\%$ pullup resistor to meet 80286, 80286-6 and 80286-4 timing requirements.

 Note 5: PCLK and RESET loading: $C_L = 75\text{pF}$.

Note 6: t4 refers to any allowable CLK period.

 $\overline{\text{READY}}$ loading:

CPU Frequency	10 MHz	12.5 MHz
Resistor	700 Ω	600 Ω
CL	150 pF	150 pF
I_{OL}	7 mA	9 mA

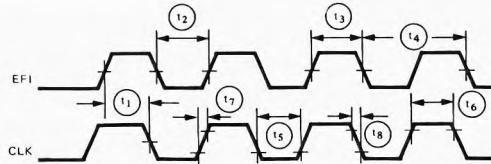
Timing Waveforms
CLK as a FUNCTION of EFI

Note: The EFI input LOW and HIGH times as shown are required to guarantee the CLK LOW and HIGH times shown.

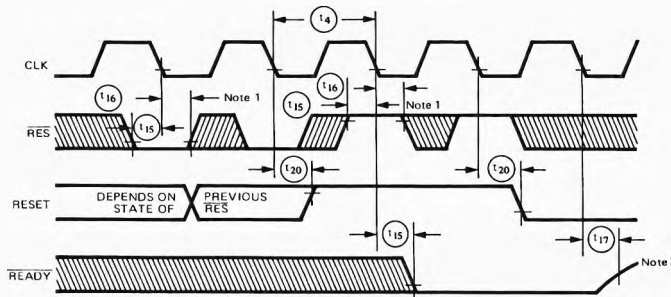
RESET and READY TIMING as a FUNCTION of RES with S1 and S0 HIGH

Note 1: This is an asynchronous input. The setup and hold times shown are required to guarantee the response shown.

Note 2: Tie 700 ohm $\pm 5\%$ pullup resistor to the $\overline{\text{READY}}$ output.

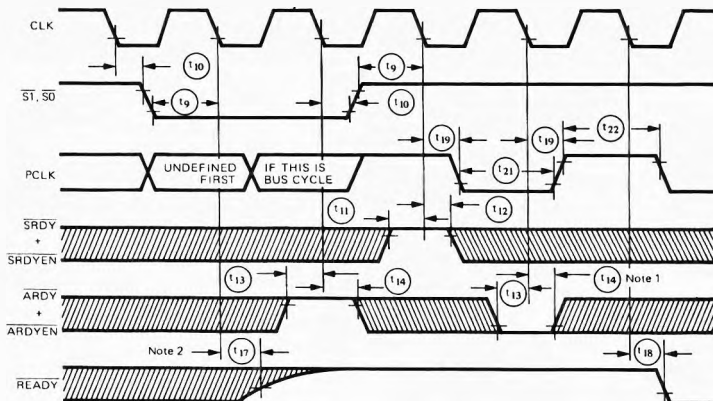
READY and PCLK Timing with RES HIGH

Note 1: This is an asynchronous input. The setup and hold times shown are required to guarantee the response shown.

Note 2: Tie 700 ohm $\pm 5\%$ pullup resistor to the $\overline{\text{READY}}$ output.

Ordering Information

Product	Frequency
UM82C284-10	10 MHz
UM82C284-12	12.5 MHz