

## SERIES ULS-2800H AND ULS-2800R

### HIGH-VOLTAGE, HIGH-CURRENT DARLINGTON ARRAYS

**MIL-STD-883 Compliant**

**FEATURES**

- TTL, DTL, PMOS, or CMOS Compatible Inputs
- Peak Output Current to 600 mA
- Transient-Protected Outputs
- Side-Brazed Hermetic Package
- Cer-DIP Hermetic Package
- High-Reliability Screening to MIL-STD-883, Class B
- -55°C to +125°C Temperature Range

**D**ESIGNED TO SERVE as interface between low-level logic circuitry and high-power loads, Series ULS-2800H and ULS-2800R arrays consist of eight silicon NPN Darlington power drivers on a common monolithic substrate. They are ideally suited to driving relays, solenoids, lamps, and other devices in high-reliability military or aerospace applications with up to 3 A output current per package.

These devices are screened to MIL-STD-883, Class B and are supplied in either the popular glass/metal side-brazed 18-pin hermetic package (suffix 'H') or ceramic/glass cer-DIP hermetic package (suffix 'R'). Both package styles conform to the dimensional requirements of MIL-M-38510 and are rated for operation over the full military temperature range of -55°C to +125°C. Reverse-bias burn-in and 100% high-reliability screening are standard.

The 30 integrated circuits described in this bulletin permit the circuit designer to select the optimal device for any application. In addition to the two package styles, there are five input characteristics, two output-voltage ratings, and two output-current ratings. The appropriate part for specific applications can be determined from the Device Part Number Designation chart. All units have open-collector outputs and on-chip diodes for inductive-load transient suppression.

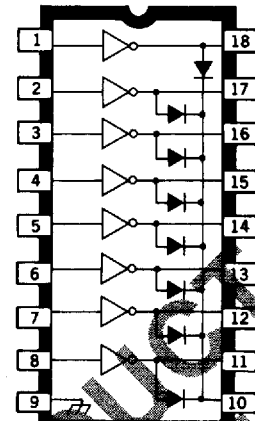

Dwg. No. A-11-22

**Device Part Number Designation**

$V_{CE(MAX)}$	50 V	50 V	95 V
$I_{C(MAX)}$	500 mA	600 mA	500 mA

	Part Number		
General Purpose PMOS, CMOS	ULS-2801*	ULS-2811*	ULS-2821*
14-25 V PMOS	ULS-2802*	ULS-2812*	ULS-2822*
5 V TTL, CMOS	ULS-2803*	ULS-2813*	ULS-2823*
6-15 V CMOS, PMOS	ULS-2804*	ULS-2814*	ULS-2824*
High-Output TTL	ULS-2805*	ULS-2815*	ULS-2825*

\*Complete part number includes a final letter to indicate package (H = glass/metal side-brazed, R = ceramic/glass cer-DIP)

# SERIES ULS-2800H AND ULS-2800R HIGH-VOLTAGE, HIGH-CURRENT DARLINGTON ARRAYS

## ABSOLUTE MAXIMUM RATINGS

Output Voltage, $V_{CE}$	
(ULS-280X*, ULS-281X*)	50 V
(ULS-282X*)	95 V
Input Voltage, $V_{IN}$	
(ULS-28X2, X3, X4*)	30 V
(ULS-28X5*)	15 V
Peak Output Current, $I_{OUT}$	
(ULS-280X*, ULS-282X*)	500 mA
(ULS-281X*)	600 mA
Ground Terminal Current, $I_{GND}$	3.0 A
Continuous Input Current, $I_{IN}$	25 mA
Power Dissipation, $P_D$	
(one Darlington pair)	1.0 W
(total package)	See Graph
Operating Temperature Range, $T_A$	-55°C to +125°C
Storage Temperature Range, $T_S$	-65°C to +150°C

## ALLOWABLE PACKAGE POWER DISSIPATION

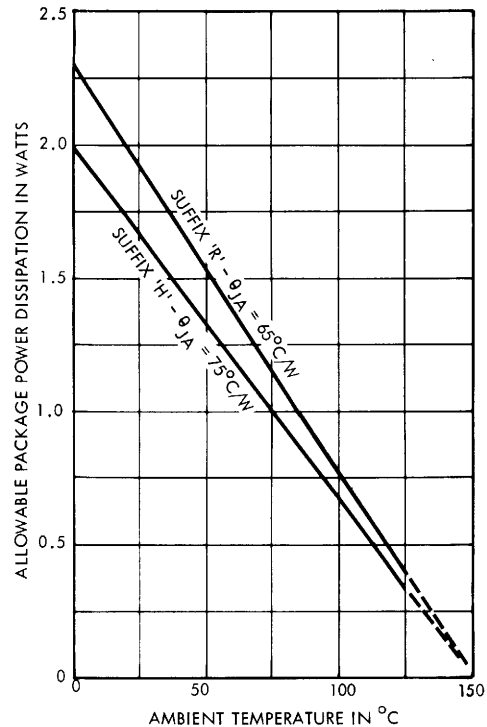

Dwg. No. A-10,879A

## PARTIAL SCHEMATICS

**ULS-28X1\***  
(Each Driver)

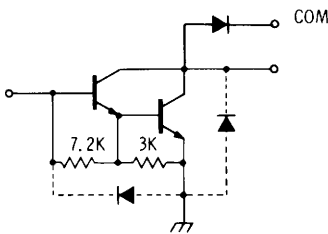

Dwg. No. A-9595

**ULS-28X2\***  
(Each Driver)

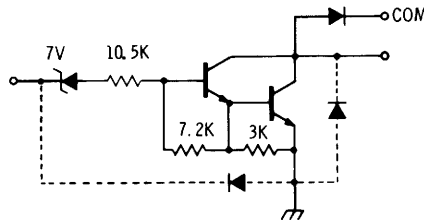

DWG. No. A-9650

Dwg. No. A-9650

**ULS-28X3\***  
(Each Driver)

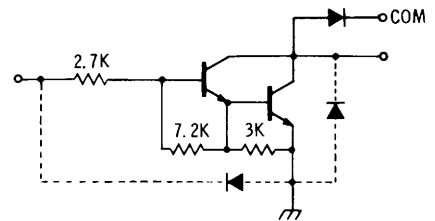

DWG. No. A-9651

Dwg. No. A-9651

**ULS-28X4\***  
(Each Driver)

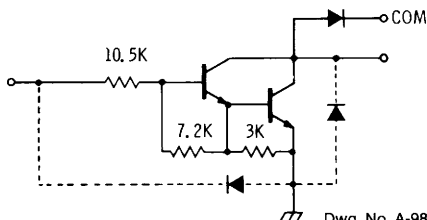

Dwg. No. A-9898A

**ULS-28X5\***  
(Each Driver)

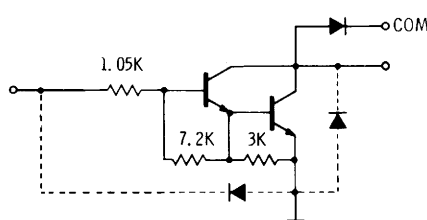

Dwg. No. A-10,228

\*Complete part number includes a final letter to indicate package (H = glass/metal side-brazed, R = ceramic/glass cer-DIP).  
X = digit to identify specific device. Specification or limit shown applies to family of devices with remaining digits as shown.

**SERIES ULS-2800H AND ULS-2800R**

**ELECTRICAL CHARACTERISTICS over operating temperature range (unless otherwise noted)**

Characteristic	Symbol	Applicable Devices	Test Conditions			Limits			
			Temp.	Voltage/Current	Fig.	Min.	Typ.	Max.	Units
Output Leakage Current	$I_{CEX}$	All		$V_{CE} = 50\text{ V}$	1A	—	—	100	$\mu\text{A}$
		ULS-2802*		$V_{CE} = 50\text{ V}, V_{IN} = 6\text{ V}$	1B	—	—	500	$\mu\text{A}$
		ULS-2804*		$V_{CE} = 50\text{ V}, V_{IN} = 1\text{ V}$	1B	—	—	500	$\mu\text{A}$
Collector-Emitter Saturation Voltage	$V_{CE(SAT)}$	All	- 55°C	$I_C = 350\text{ mA}, I_B = 850\ \mu\text{A}$	2	—	1.6	1.8	V
				$I_C = 200\text{ mA}, I_B = 550\ \mu\text{A}$	2	—	1.3	1.5	V
				$I_C = 100\text{ mA}, I_B = 350\ \mu\text{A}$	2	—	1.1	1.3	V
			+ 25°C	$I_C = 350\text{ mA}, I_B = 500\ \mu\text{A}$	2	—	1.25	1.6	V
				$I_C = 200\text{ mA}, I_B = 350\ \mu\text{A}$	2	—	1.1	1.3	V
				$I_C = 100\text{ mA}, I_B = 250\ \mu\text{A}$	2	—	0.9	1.1	V
			+ 125°C	$I_C = 350\text{ mA}\dagger, I_B = 500\ \mu\text{A}$	2	—	1.6	1.8	V
				$I_C = 200\text{ mA}, I_B = 350\ \mu\text{A}$	2	—	1.3	1.5	V
				$I_C = 100\text{ mA}, I_B = 250\ \mu\text{A}$	2	—	1.1	1.3	V
Input Current	$I_{IN(ON)}$	ULS-2802*		$V_{IN} = 17\text{ V}$	3	480	850	1300	$\mu\text{A}$
		ULS-2803*		$V_{IN} = 3.85\text{ V}$	3	650	930	1350	$\mu\text{A}$
		ULS-2804*		$V_{IN} = 5.0\text{ V}$	3	240	350	500	$\mu\text{A}$
				$V_{IN} = 12\text{ V}$	3	650	1000	1450	$\mu\text{A}$
		ULS-2805*		$V_{IN} = 3.0\text{ V}$	3	—	1500	2400	$\mu\text{A}$
Input Voltage	$V_{IN(OFF)}$	All	+ 125°C	$I_C = 500\ \mu\text{A}$	4	25	50	—	$\mu\text{A}$
		ULS-2802*	- 55°C	$V_{CE} = 2.0\text{ V}, I_C = 300\text{ mA}$	5	—	—	18	V
+ 125°C	$V_{CE} = 2.0\text{ V}, I_C = 300\text{ mA}$			5	—	—	13	V	
ULS-2803*	- 55°C		$V_{CE} = 2.0\text{ V}, I_C = 200\text{ mA}$	5	—	—	3.3	V	
			$V_{CE} = 2.0\text{ V}, I_C = 250\text{ mA}$	5	—	—	3.6	V	
			$V_{CE} = 2.0\text{ V}, I_C = 300\text{ mA}$	5	—	—	3.9	V	
+ 125°C	$V_{CE} = 2.0\text{ V}, I_C = 200\text{ mA}\dagger$		5	—	—	2.4	V		
	$V_{CE} = 2.0\text{ V}, I_C = 250\text{ mA}\dagger$		5	—	—	2.7	V		
	$V_{CE} = 2.0\text{ V}, I_C = 300\text{ mA}\dagger$		5	—	—	3.0	V		
ULS-2804*	- 55°C		$V_{CE} = 2.0\text{ V}, I_C = 125\text{ mA}$	5	—	—	6.0	V	
			$V_{CE} = 2.0\text{ V}, I_C = 200\text{ mA}$	5	—	—	8.0	V	
			$V_{CE} = 2.0\text{ V}, I_C = 275\text{ mA}$	5	—	—	10	V	
	+ 125°C		$V_{CE} = 2.0\text{ V}, I_C = 350\text{ mA}$	5	—	—	12	V	
			$V_{CE} = 2.0\text{ V}, I_C = 125\text{ mA}$	5	—	—	5.0	V	
			$V_{CE} = 2.0\text{ V}, I_C = 200\text{ mA}\dagger$	5	—	—	6.0	V	
ULS-2805*	- 55°C		$V_{CE} = 2.0\text{ V}, I_C = 275\text{ mA}\dagger$	5	—	—	7.0	V	
		$V_{CE} = 2.0\text{ V}, I_C = 350\text{ mA}\dagger$	5	—	—	8.0	V		
		$V_{CE} = 2.0\text{ V}, I_C = 350\text{ mA}\dagger$	5	—	—	3.0	V		
D-C Forward Current Transfer Ratio	$h_{FE}$	ULS2801*	- 55°C	$V_{CE} = 2.0\text{ V}, I_C = 350\text{ mA}$	2	500	—	—	—
			+ 25°C	$V_{CE} = 2.0\text{ V}, I_C = 350\text{ mA}$	2	1000	—	—	—
Turn-On Delay	$t_{PLH}$	All	+ 25°C		8	—	250	1000	ns
Turn-Off Delay	$t_{PHL}$	All	+ 25°C		8	—	250	1000	ns
Clamp Diode Leakage Current	$I_R$	All		$V_R = 50\text{ V}$	6	—	—	50	$\mu\text{A}$
Clamp Diode Forward Voltage	$V_f$	All		$I_f = 350\text{ mA}\dagger$	7	—	1.7	2.0	V

\*Complete part number includes a final letter to indicate package (H = glass/metal side-brazed, R = ceramic/glass cer-DIP).

Note 1: All limits stated apply to the complete Darlington series except as specified for a single device type.

Note 2: The  $I_{IN(OFF)}$  current limit guarantees against partial turn-on of the output.

Note 3: The  $V_{IN(ON)}$  voltage limit guarantees a minimum output sink current per the specified test conditions.

†Pulse Test,  $t_p \leq 1\ \mu\text{s}$ , see graph.

**SERIES ULS-2800H AND ULS-2800R  
HIGH-VOLTAGE, HIGH-CURRENT DARLINGTON ARRAYS**

**SERIES ULS-2810H AND ULS-2810R**

**ELECTRICAL CHARACTERISTICS over operating temperature range (unless otherwise noted)**

Characteristic	Symbol	Applicable Devices	Test Conditions			Limits			
			Temp.	Voltage/Current	Fig.	Min.	Typ.	Max.	Units
Output Leakage Current	$I_{CEX}$	All		$V_{CE} = 50\text{ V}$	1A	—	—	100	$\mu\text{A}$
		ULS-2812*		$V_{CE} = 50\text{ V}, V_{IN} = 6\text{ V}$	1B	—	—	500	$\mu\text{A}$
		ULS-2814*		$V_{CE} = 50\text{ V}, V_{IN} = 1\text{ V}$	1B	—	—	500	$\mu\text{A}$
Collector-Emitter Saturation Voltage	$V_{CE(SAT)}$	All	-55°C	$I_C = 500\text{ mA}, I_B = 1100\ \mu\text{A}$	2	—	1.8	2.1	V
				$I_C = 350\text{ mA}, I_B = 850\ \mu\text{A}$	2	—	1.6	1.8	V
				$I_C = 200\text{ mA}, I_B = 550\ \mu\text{A}$	2	—	1.3	1.5	V
			+25°C	$I_C = 500\text{ mA}, I_B = 600\ \mu\text{A}$	2	—	1.7	1.9	V
				$I_C = 350\text{ mA}, I_B = 500\ \mu\text{A}$	2	—	1.25	1.6	V
				$I_C = 200\text{ mA}, I_B = 350\ \mu\text{A}$	2	—	1.1	1.3	V
			+125°C	$I_C = 500\text{ mA}^\dagger, I_B = 600\ \mu\text{A}$	2	—	1.8	2.1	V
				$I_C = 350\text{ mA}^\dagger, I_B = 500\ \mu\text{A}$	2	—	1.6	1.8	V
				$I_C = 200\text{ mA}, I_B = 350\ \mu\text{A}$	2	—	1.3	1.5	V
Input Current	$I_{IN(ON)}$	ULS-2812*		$V_{IN} = 17\text{ V}$	3	480	850	1300	$\mu\text{A}$
		ULS-2813*		$V_{IN} = 3.85\text{ V}$	3	650	930	1350	$\mu\text{A}$
		ULS-2814*		$V_{IN} = 5.0\text{ V}$	3	240	350	500	$\mu\text{A}$
				$V_{IN} = 12\text{ V}$	3	650	1000	1450	$\mu\text{A}$
		ULS-2815*		$V_{IN} = 3.0\text{ V}$	3	—	1500	2400	$\mu\text{A}$
	$I_{IN(OFF)}$	All	+125°C	$I_C = 500\ \mu\text{A}$	4	25	50	—	$\mu\text{A}$
Input Voltage	$V_{IN(ON)}$	ULS-2812*	-55°C	$V_{CE} = 2.0\text{ V}, I_C = 500\text{ mA}$	5	—	—	23.5	V
			+125°C	$V_{CE} = 2.0\text{ V}, I_C = 500\text{ mA}$	5	—	—	17	V
		ULS-2013*	-55°C	$V_{CE} = 2.0\text{ V}, I_C = 250\text{ mA}$	5	—	—	3.6	V
				$V_{CE} = 2.0\text{ V}, I_C = 300\text{ mA}$	5	—	—	3.9	V
				$V_{CE} = 2.0\text{ V}, I_C = 500\text{ mA}$	5	—	—	6.0	V
			+125°C	$V_{CE} = 2.0\text{ V}, I_C = 250\text{ mA}^\dagger$	5	—	—	2.7	V
				$V_{CE} = 2.0\text{ V}, I_C = 300\text{ mA}^\dagger$	5	—	—	3.0	V
				$V_{CE} = 2.0\text{ V}, I_C = 500\text{ mA}^\dagger$	5	—	—	3.5	V
		ULS-2814*	-55°C	$V_{CE} = 2.0\text{ V}, I_C = 275\text{ mA}$	5	—	—	10	V
				$V_{CE} = 2.0\text{ V}, I_C = 350\text{ mA}$	5	—	—	12	V
				$V_{CE} = 2.0\text{ V}, I_C = 500\text{ mA}$	5	—	—	17	V
			+125°C	$V_{CE} = 2.0\text{ V}, I_C = 275\text{ mA}^\dagger$	5	—	—	7.0	V
				$V_{CE} = 2.0\text{ V}, I_C = 350\text{ mA}^\dagger$	5	—	—	8.0	V
				$V_{CE} = 2.0\text{ V}, I_C = 500\text{ mA}^\dagger$	5	—	—	9.5	V
		ULS-2815*	-55°C	$V_{CE} = 2.0\text{ V}, I_C = 350\text{ mA}$	5	—	—	3.0	V
				$V_{CE} = 2.0\text{ V}, I_C = 500\text{ mA}$	5	—	—	3.5	V
			+125°C	$V_{CE} = 2.0\text{ V}, I_C = 350\text{ mA}^\dagger$	5	—	—	2.4	V
				$V_{CE} = 2.0\text{ V}, I_C = 500\text{ mA}^\dagger$	5	—	—	2.6	V
D-C Forward Current Transfer Ratio	$h_{FE}$	ULS-2811*	-55°C	$V_{CE} = 2.0\text{ V}, I_C = 500\text{ mA}$	2	450	—	—	—
			+25°C	$V_{CE} = 2.0\text{ V}, I_C = 500\text{ mA}$	2	900	—	—	—
Turn-On Delay	$t_{PLH}$	All	+25°C		8	—	250	1000	ns
Turn-Off Delay	$t_{PHL}$	All	+25°C		8	—	250	1000	ns
Clamp Diode Leakage Current	$I_R$	All		$V_R = 50\text{ V}$	6	—	—	50	$\mu\text{A}$
Clamp Diode Forward Voltage	$V_f$	All		$I_f = 350\text{ mA}^\dagger$	7	—	1.7	2.0	V
				$I_f = 500\text{ mA}^\dagger$	7	—	—	2.5	V

\*Complete part number includes a final letter to indicate package (H = glass/metal side-brazed, R = ceramic/glass cer-DIP).

Note 1: All limits stated apply to the complete Darlington series except as specified for a single device type.

Note 2: The  $I_{IN(OFF)}$  current limit guarantees against partial turn-on of the output.

Note 3: The  $V_{IN(ON)}$  voltage limit guarantees a minimum output sink current per the specified test conditions.

†Pulse Test,  $t_p \leq 1\ \mu\text{s}$ , see graph.

**SERIES ULS-2820H AND ULS-2820R**  
**ELECTRICAL CHARACTERISTICS over operating temperature range (unless otherwise noted)**

Characteristic	Symbol	Applicable Devices	Test Conditions			Limits					
			Temp.	Voltage/Current	Fig.	Min.	Typ.	Max.	Units		
Output Leakage Current	$I_{CEX}$	All		$V_{CE} = 95\text{ V}$	1A	—	—	100	$\mu\text{A}$		
		ULS-2822*		$V_{CE} = 95\text{ V}, V_{IN} = 6\text{ V}$	1B	—	—	500	$\mu\text{A}$		
		ULS-2824*	25°C	$V_{CE} = 95\text{ V}, V_{IN} = 1\text{ V}$	1B	—	—	500	$\mu\text{A}$		
			+125°C	$V_{CE} = 95\text{ V}, V_{IN} = 0.5\text{ V}$	1B	—	—	500	$\mu\text{A}$		
Collector-Emitter Saturation Voltage	$V_{CE(SAT)}$	All	-55°C	$I_C = 350\text{ mA}, I_B = 850\ \mu\text{A}$	2	—	1.6	1.8	V		
				$I_C = 200\text{ mA}, I_B = 550\ \mu\text{A}$	2	—	1.3	1.5	V		
				$I_C = 100\text{ mA}, I_B = 350\ \mu\text{A}$	2	—	1.1	1.3	V		
			+25°C	$I_C = 350\text{ mA}, I_B = 500\ \mu\text{A}$	2	—	1.25	1.6	V		
				$I_C = 200\text{ mA}, I_B = 350\ \mu\text{A}$	2	—	1.1	1.3	V		
				$I_C = 100\text{ mA}, I_B = 250\ \mu\text{A}$	2	—	0.9	1.1	V		
			+125°C	$I_C = 350\text{ mA}\dagger, I_B = 500\ \mu\text{A}$	2	—	1.6	1.8	V		
				$I_C = 200\text{ mA}, I_B = 350\ \mu\text{A}$	2	—	1.3	1.5	V		
				$I_C = 100\text{ mA}, I_B = 250\ \mu\text{A}$	2	—	1.1	1.3	V		
Input Current	$I_{IN(ON)}$	ULS-2822*		$V_{IN} = 17\text{ V}$	3	480	850	1300	$\mu\text{A}$		
		ULS-2823*		$V_{IN} = 3.85\text{ V}$	3	650	930	1350	$\mu\text{A}$		
		ULS-2824*		$V_{IN} = 5.0\text{ V}$	3	240	350	500	$\mu\text{A}$		
				$V_{IN} = 12\text{ V}$	3	650	1000	1450	$\mu\text{A}$		
		ULS-2825*		$V_{IN} = 3.0\text{ V}$	3	—	1500	2400	$\mu\text{A}$		
	$I_{IN(OFF)}$	All	+125°C	$I_C = 500\ \mu\text{A}$	4	20	50	—	$\mu\text{A}$		
Input Voltage	$V_{IN(ON)}$	ULS-2822*	-55°C	$V_{CE} = 2.0\text{ V}, I_C = 300\text{ mA}$	5	—	—	18	V		
			+125°C	$V_{CE} = 2.0\text{ V}, I_C = 300\text{ mA}$	5	—	—	13	V		
		ULS-2823*	-55°C	$V_{CE} = 2.0\text{ V}, I_C = 200\text{ mA}$	5	—	—	3.3	V		
				$V_{CE} = 2.0\text{ V}, I_C = 250\text{ mA}$	5	—	—	3.6	V		
				$V_{CE} = 2.0\text{ V}, I_C = 300\text{ mA}$	5	—	—	3.9	V		
			+125°C	$V_{CE} = 2.0\text{ V}, I_C = 200\text{ mA}\dagger$	5	—	—	2.4	V		
				$V_{CE} = 2.0\text{ V}, I_C = 250\text{ mA}\dagger$	5	—	—	2.7	V		
				$V_{CE} = 2.0\text{ V}, I_C = 300\text{ mA}\dagger$	5	—	—	3.0	V		
		ULS-2824*	-55°C	$V_{CE} = 2.0\text{ V}, I_C = 125\text{ mA}$	5	—	—	6.0	V		
				$V_{CE} = 2.0\text{ V}, I_C = 200\text{ mA}$	5	—	—	8.0	V		
				$V_{CE} = 2.0\text{ V}, I_C = 275\text{ mA}$	5	—	—	10	V		
				$V_{CE} = 2.0\text{ V}, I_C = 350\text{ mA}$	5	—	—	12	V		
			+125°C	$V_{CE} = 2.0\text{ V}, I_C = 125\text{ mA}$	5	—	—	5.0	V		
				$V_{CE} = 2.0\text{ V}, I_C = 200\text{ mA}\dagger$	5	—	—	6.0	V		
				$V_{CE} = 2.0\text{ V}, I_C = 275\text{ mA}\dagger$	5	—	—	7.0	V		
				$V_{CE} = 2.0\text{ V}, I_C = 350\text{ mA}\dagger$	5	—	—	8.0	V		
				ULS-2825*	-55°C	$V_{CE} = 2.0\text{ V}, I_C = 350\text{ mA}$	5	—	—	3.0	V
					+125°C	$V_{CE} = 2.0\text{ V}, I_C = 350\text{ mA}\dagger$	5	—	—	2.4	V
		D-C Forward Current Transfer Ratio	$h_{FE}$	ULS2821*	-55°C	$V_{CE} = 2.0\text{ V}, I_C = 350\text{ mA}$	2	500	—	—	—
					+25°C	$V_{CE} = 2.0\text{ V}, I_C = 350\text{ mA}$	2	1000	—	—	—
Turn-On Delay	$t_{PLH}$	All	+25°C		8	—	250	1000	ns		
Turn-Off Delay	$t_{PHL}$	All	+25°C		8	—	250	1000	ns		
Clamp Diode Leakage Current	$I_R$	All		$V_R = 95\text{ V}$	6	—	—	50	$\mu\text{A}$		
Clamp Diode Forward Voltage	$V_f$	All		$I_f = 350\text{ mA}\dagger$	7	—	1.7	2.0	V		

\*Complete part number includes a final letter to indicate package (H = glass/metal side-brazed, R = ceramic/glass cer-DIP).

Note 1: All limits stated apply to the complete Darlington series except as specified for a single device type.

Note 2: The  $I_{IN(OFF)}$  current limit guarantees against partial turn-on of the output.

Note 3: The  $V_{IN(ON)}$  voltage limit guarantees a minimum output sink current per the specified test conditions.

†Pulse Test,  $t_p \leq 1\ \mu\text{s}$ , see graph.

**TEST FIGURES**

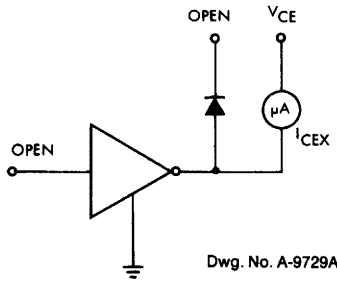

**FIGURE 1A**

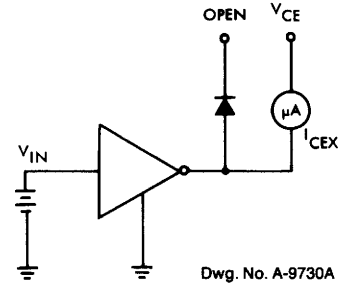

**FIGURE 1B**

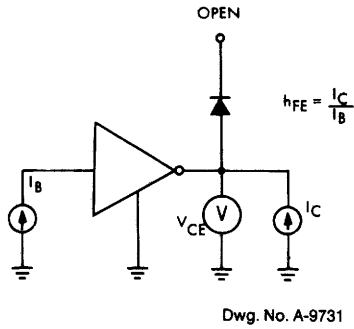

**FIGURE 2**

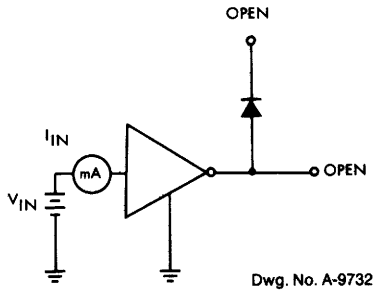

**FIGURE 3**

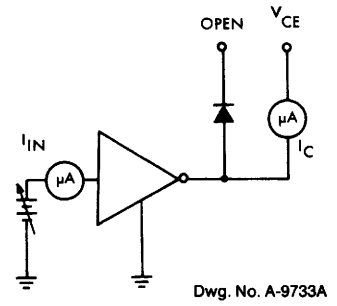

**FIGURE 4**

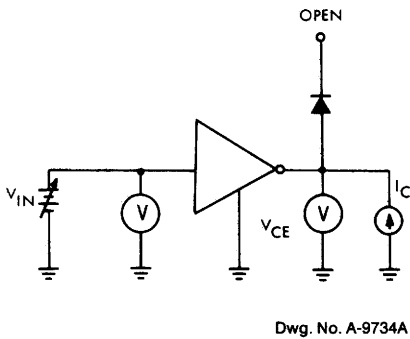

**FIGURE 5**

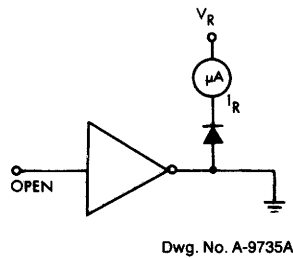

**FIGURE 6**

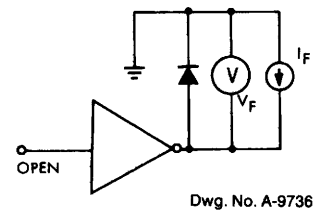

**FIGURE 7**

**SERIES ULS-2800H AND ULS-2800R  
HIGH-VOLTAGE, HIGH-CURRENT DARLINGTON ARRAYS**

	$V_{in}$
ULS-28X1*	3.5 V
ULS-28X2*	13 V
ULS-28X3*	3.5 V
ULS-28X4*	12 V
ULS-28X5*	3.5 V

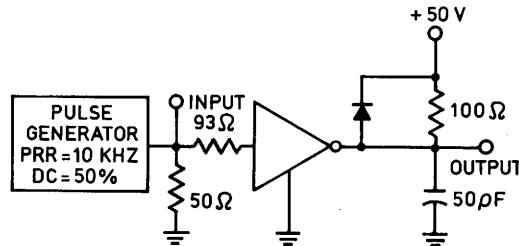

Dwg. No. A-13,273

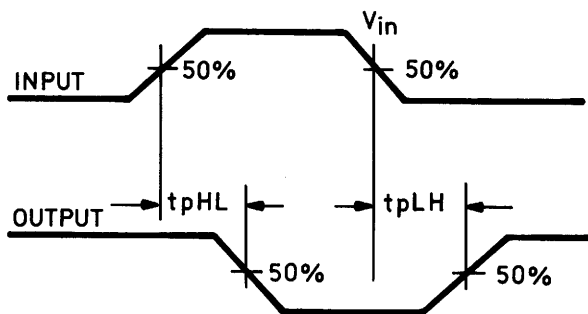

Dwg. No. A-13,272

\* Complete part number includes a final letter to indicate package.  
X = Digit to identify specific device. Specification shown applies to family of devices with remaining digits as shown.

**FIGURE 8**

**COLLECTOR CURRENT AS A FUNCTION OF SATURATION VOLTAGE**

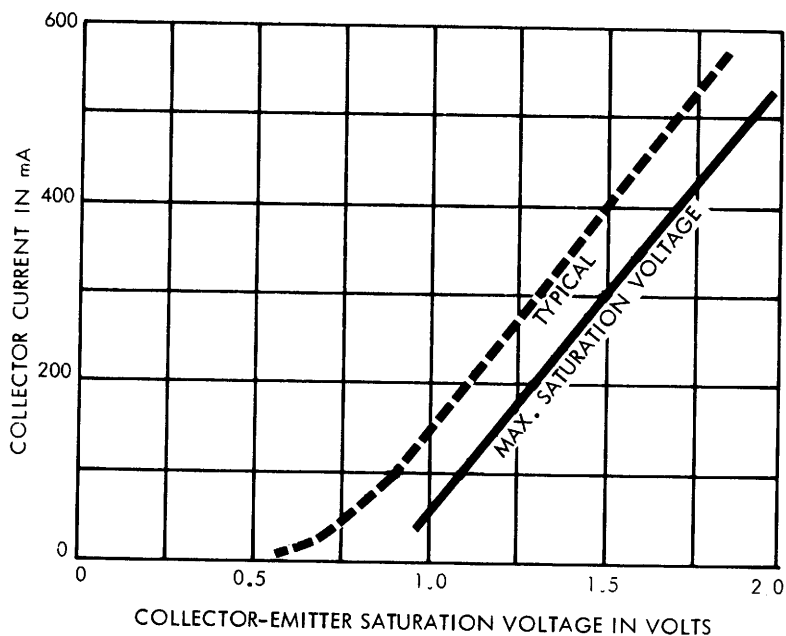

Dwg. No. A-9754C

**COLLECTOR CURRENT AS A FUNCTION OF INPUT CURRENT**

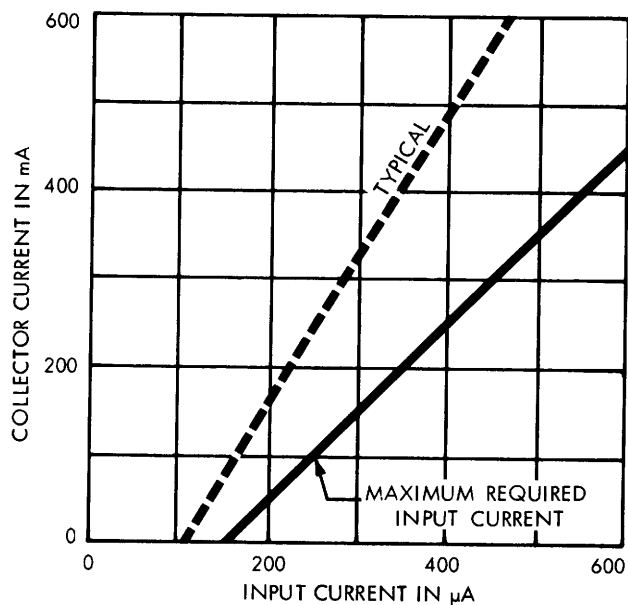

Dwg. No. A-10,872B

**SERIES ULS-2800H**

**PEAK COLLECTOR CURRENT  
AS A FUNCTION OF DUTY CYCLE AT +50°C**

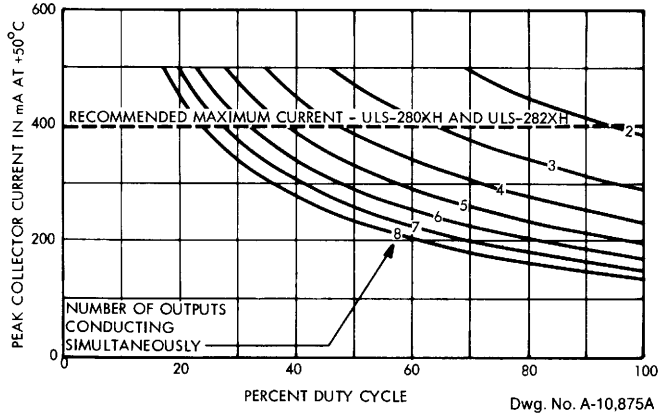

**PEAK COLLECTOR CURRENT  
AS A FUNCTION OF DUTY CYCLE AT +75°C**

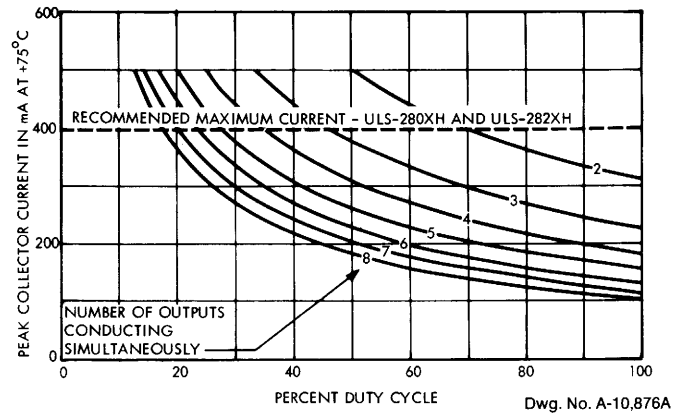

**PEAK COLLECTOR CURRENT  
AS A FUNCTION OF DUTY CYCLE AT +100°C**

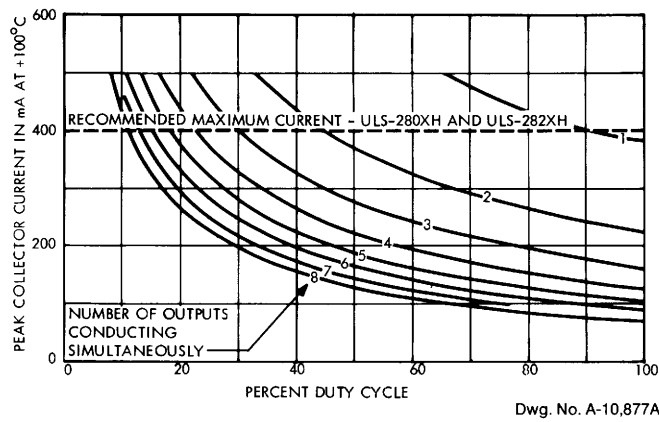

**PEAK COLLECTOR CURRENT  
AS A FUNCTION OF DUTY CYCLE AT +125°C**

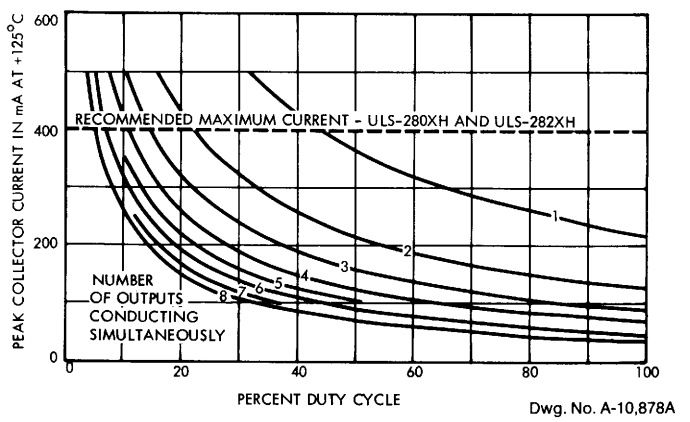

*X = digit to identify specific device. Specification or limit shown applies to family of devices with remaining digits as shown.*



**SERIES ULS-2800R**

**PEAK COLLECTOR CURRENT  
AS A FUNCTION OF DUTY CYCLE AT +50°C**

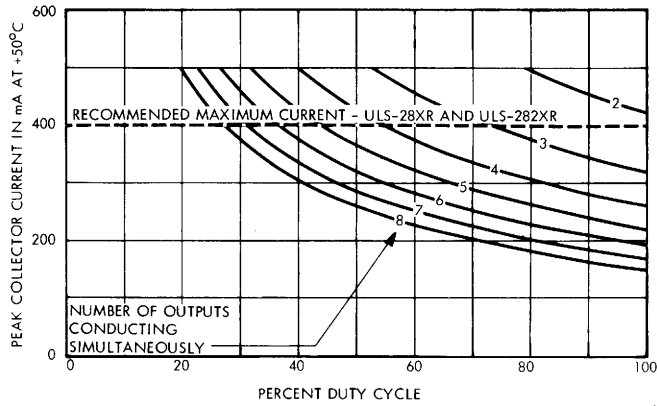

Dwg. No. A-10,870A

**PEAK COLLECTOR CURRENT  
AS A FUNCTION OF DUTY CYCLE AT +75°C**

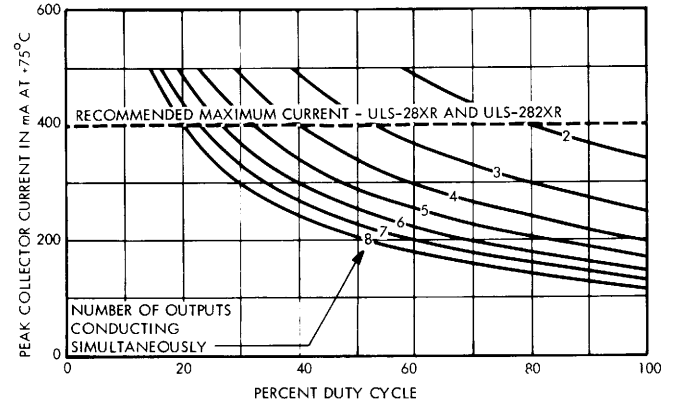

Dwg. No. A-10,871A

**PEAK COLLECTOR CURRENT  
AS A FUNCTION OF DUTY CYCLE AT +100°C**

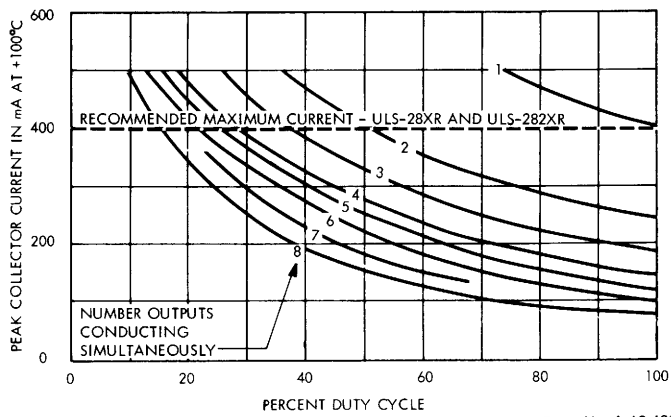

Dwg. No. A-12,466

**PEAK COLLECTOR CURRENT  
AS A FUNCTION OF DUTY CYCLE AT +125°C**

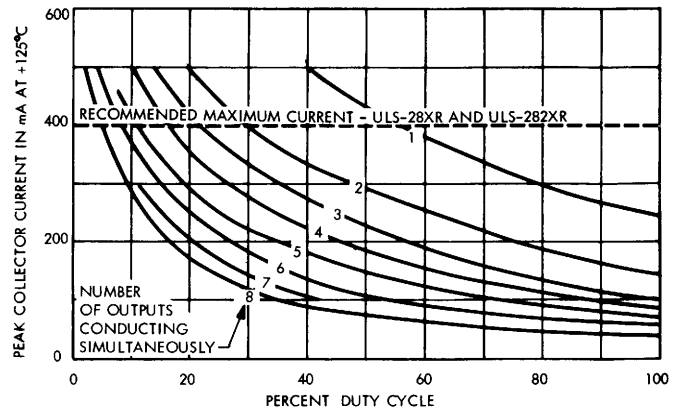

Dwg. No. A-12,467

*X = digit to identify specific device. Specification or limit shown applies to family of devices with remaining digits as shown.*

**INPUT CURRENT AS A FUNCTION OF INPUT VOLTAGE**

**ULS-28X2**

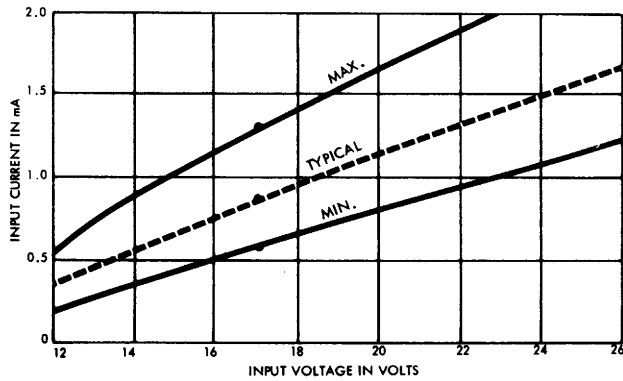

Dwg. No. A-10,225A

**ULS-28X3**

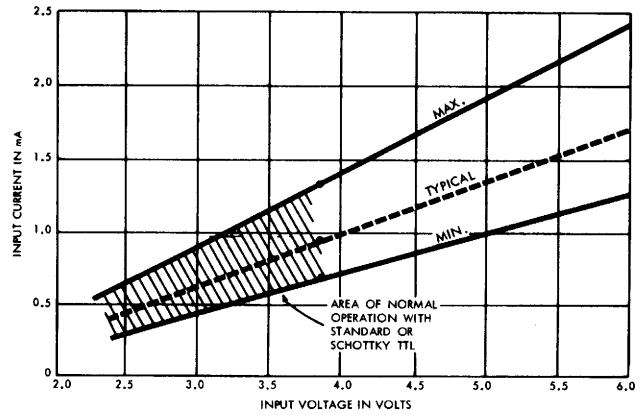

Dwg. No. A-10,224A

**ULS-28X4**

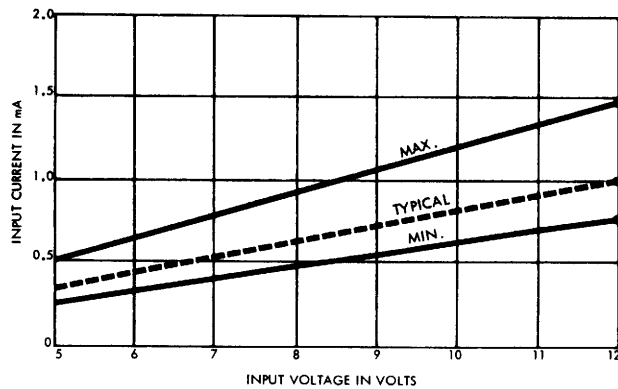

Dwg. No. A-10,226A

**ULS-28X5**

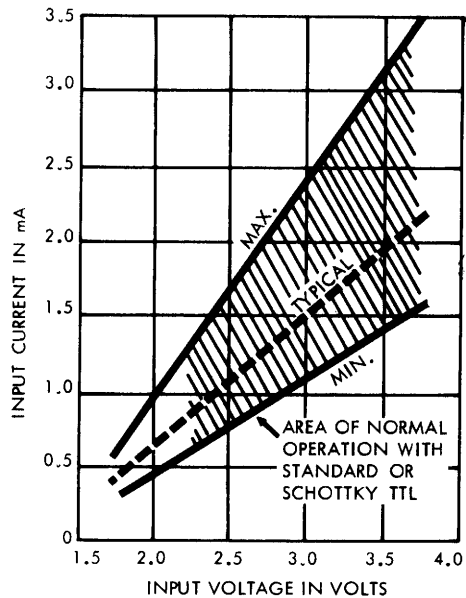

Dwg. No. A-10,874A

*X = digit to identify specific device. Specification or limit shown applies to family of devices with remaining digits as shown.*

## HERMETIC GLASS/METAL 'H' PACKAGE

### DIMENSIONS IN INCHES

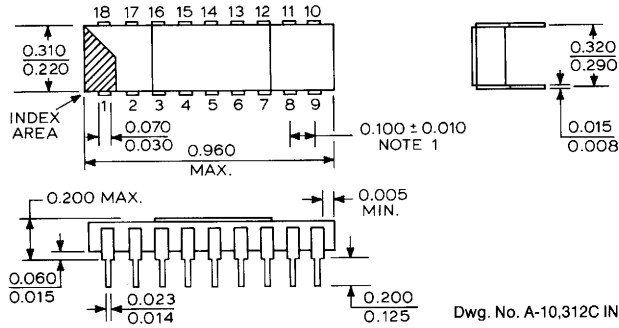

### DIMENSIONS IN MILLIMETERS

Based on 1" = 25.4 mm

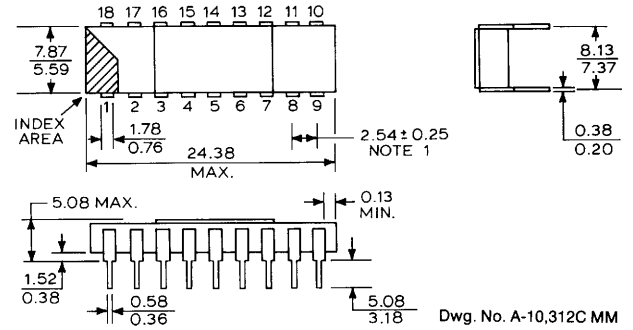

This package conforms to military specification MIL-M-38510, case outline D-6, configuration 3. Devices using this package are marked to indicate compliance to the latest issue of MIL-STD-883. For example: ULS2801H-883.

## HERMETIC CERAMIC/GLASS 'R' PACKAGE

### DIMENSIONS IN INCHES

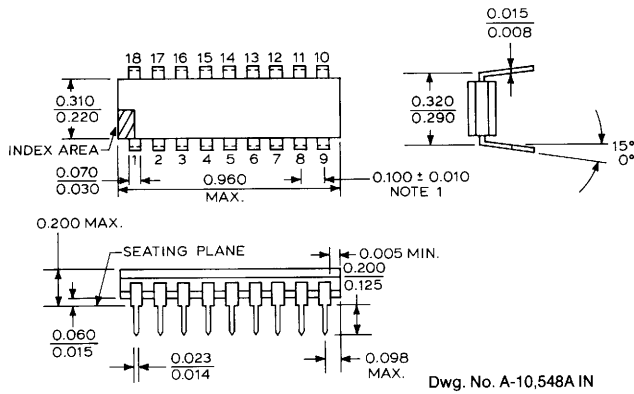

### DIMENSIONS IN MILLIMETERS

Based on 1" = 25.4 mm

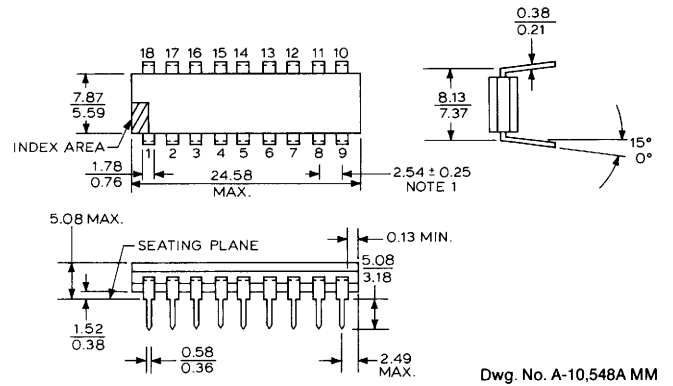

This package conforms to military specification MIL-M-38510, case outline D-6, configuration 1. Devices using this package are marked to indicate compliance to the latest issue of MIL-STD-883. For example: ULS2803R-883.

#### NOTES:

1. Lead spacing tolerance is non-cumulative.
2. Exact body and lead configuration at vendor's option within limits shown.
3. Lead gauge plane is 0.030 in. (0.76 mm) max. below seating plane.

## SALES OFFICES

**UNITED STATES**
**ALABAMA**

**EPI Inc.**  
Suite 13 — 9694 Hwy. 20 W  
Madison 35758  
Tel. 205/461-7000

**Electramark Inc.**  
Suite 21  
3322 South Memorial Parkway  
Huntsville 35801  
Tel. 205/883-9948

**ARIZONA**

**Sprague Electric Company**  
Suite 209 — 1819 S. Dobson Rd.  
Mesa 85202 — 5690  
Tel. 602/244-0154  
Tel. 602/831-6762

**Sprague Electric Company**  
Suite 601  
1150 E. Pennsylvania Street  
Tucson 85714 — 1640  
Tel. 602/746-0955

**CALIFORNIA (Metro. L.A.)**

**Sprague Electric Company**  
Suite 150 — 3100 S. Harbor Blvd.  
Santa Ana 92704  
Tel. 714/549-9913

**Sprague Electric Company**  
Suite 459  
15350 Sherman Way  
Van Nuys 91406  
Tel. 818/994-6500

**Sprague Electric Company**  
Suite 126  
4300 Stevens Creek Boulevard  
San Jose 95129 — 1249  
Tel. 408/241-7111

**(Northern)**

**William J. Purdy Company**  
770 Airport Blvd.  
Burlingame 94010 — 1927  
Tel. 415/347-7701

**(San Diego)**

**Miner Associates, Inc.**  
Suite 117 — 10721 Treena Street  
San Diego 92131 — 1009  
Tel. 619/566-9891

**COLORADO**

**William J. Purdy Company**  
5570 E. Yale Ave.  
Denver 80222 — 6907  
Tel. 303/753-6800

**Todd & Fry Associates**

P.O. Box 1689  
Longmont 80502 — 1689  
Tel. 303/776-7331

**CONNECTICUT**

**Sprague Electric Company**  
88 Main Street South  
Southbury 06488  
Tel. 203/264-9595

**Sprague Electric Company**  
120 Hartford Turnpike South  
P.O. Box 578  
Wallingford 06492 — 0578  
Tel. 203/284-8300

**Data Mark Inc.**

47 Clapboard Hill Road  
Guilford 06437 — 2261  
Tel. 203/453-0575

**DIST. OF COLUMBIA**

**Sprague Electric Company**  
Suite 311  
14333 Laurel-Bowie Road  
Laurel, MD 20708 — 1130  
Tel. 301/953-1717

**DIST. OF COLUMBIA (continued)**

**Trinkle Sales Inc.**  
P.O. Box 5320  
Cherry Hill, NJ 08034 — 0460  
Tel. 609/795-4200

**FLORIDA**

**Sprague Electric Company**  
P.O. Box 1410  
Altamonte Springs 32715 — 1410  
Tel. 305/831-3636

**Sprague Electric Company**  
Suite 419 — 1500 N.W. 62nd Street  
Ft. Lauderdale 33309 — 1802  
Tel. 305/491-7411

**Sprague Electric Company**

Suite T, Building 501  
8001 North Dale Mabry  
Tampa 33614 — 3265  
Tel. 813/935-8203

**GEORGIA**

**Electramark Inc.**  
6030 — I Unity Drive  
Norcross 30071 — 3583  
Tel. 404/446-7915

**Electronic Marketing Associates**

Suite 101  
6695 Peachtree Industrial Blvd.  
Atlanta 30360 — 2116  
Tel. 404/448-1215

**ILLINOIS (Northern)**

**Sprague Electric Company**  
Suite 410 — 1480 Renaissance Dr.  
Park Ridge 60068 — 1386  
Tel. 312/296-6620

**(Southern)**

**EPI Inc.**  
Suite 201 — 103 W. Lockwood  
St. Louis, MO 63119 — 2915  
Tel. 314/962-1411

**INDIANA**

**Sprague Electric Company**  
Suite 290 — 8200 Haverstick Road  
Indianapolis 46240  
Tel. 317/253-4247

**IOWA**

**J. R. Sales Engineering, Inc.**  
1930 St. Andrews, N. E.  
Cedar Rapids 52402  
Tel. 319/393-2232

**KANSAS**

**EPI Inc.**  
Suite 201 — 103 W. Lockwood  
St. Louis, MO 63119 — 2915  
Tel. 314/962-1411

**KENTUCKY**

**Sprague Electric Company**  
821 Corporate Drive  
Unit #16, Suite 200  
Lexington 40503  
Tel. 606/224-4230

**MARYLAND**

**Sprague Electric Company**  
Suite 311  
14333 Laurel-Bowie Road  
Laurel 20708 — 1130  
Tel. 301/792-4890  
**Trinkle Sales Inc.**  
P.O. Box 5320  
Cherry Hill, NJ 08034 — 0460  
Tel. 609/795-4200

**MASSACHUSETTS**

**Sprague Electric Company**  
10 Burr St.  
Framingham 01701 — 4617  
Tel. 617/875-3200

**Ray Perron & Co., Inc.**

P.O. Box 389  
Needham 02192 — 0009  
Tel. 617/449-6162

**MICHIGAN**

**Sprague Electric Company**  
Suite 301 — 2155 Jackson Road  
Ann Arbor 48103 — 3917  
Tel. 313/761-2014

**MINNESOTA**

**HMR, Inc.**  
9065 Lyndale Ave. South  
Minneapolis 55420 — 3520  
Tel. 612/888-2122

**MISSISSIPPI**

**EPI Inc.**  
Suite 13 — 9694 Hwy. 20 W  
Madison, AL 35758  
Tel. 205/461-7000

**MISSOURI**

**EPI Inc.**  
Suite 201 — 103 W. Lockwood  
St. Louis 63119 — 2915  
Tel. 314/962-1411

**NEBRASKA**

**J. R. Sales Engineering, Inc.**  
1930 St. Andrews, N. E.  
Cedar Rapids, Iowa 52402  
Tel. 319/393-2232

**NEW HAMPSHIRE**

**Ray Perron & Co., Inc.**  
1 Elm St.  
Dover 03820 — 3910  
Tel. 603/742-2321

**NEW JERSEY (Northern)**

**Sprague Electric Company**  
P.O. Box 1612  
Wayne 07470 — 0701  
Tel. 201/696-8200

**(Southern)**

**Trinkle Sales Inc.**  
P.O. Box 5320  
Cherry Hill 08034 — 0460  
Tel. 609/795-4200

**NEW MEXICO**

**William J. Purdy Company**  
120 LaVeta Drive NE  
Albuquerque 87108 — 1613  
Tel. 505/266-7959

**NEW YORK (Downstate)**

**Sprague Electric Company**  
2001 Palmer Ave.  
Larchmont 10538 — 2420  
Tel. 914/834-4439

**(Long Island)**

**Sprague Electric Company**  
P.O. Box 541  
Central Islip 11722 — 0541  
Tel. 516/234-8700

**(Upstate)**

**Sprague Electric Company**  
2002 Teall Ave.  
Syracuse 13206 — 1542  
Tel. 315/437-7311

**Paston-Hunter Co., Inc.**

2002 Teall Ave.  
Syracuse 13206 — 1596  
Tel. 315/437-2843

**NORTH CAROLINA**

**Sprague Electric Company**  
9741-M Southern Pine Blvd.  
Charlotte 28210 — 5560  
Tel. 704/527-1306

**Electronic Marketing Associates**

9225 Honeycutt Creek Rd.  
Raleigh 27609 — 1523  
Tel. 919/847-8800

**OHIO**

**Sprague Electric Company**  
Suite 330 — 555 Metro Place North  
Dublin 43017 — 1375  
Tel. 614/761-1881

**OREGON**

**Sprague Electric Company**  
Suite H  
16111 S.E. McGillivray Boulevard  
Vancouver, WA 98664 — 9025  
Tel. 503/225-0493  
Tel. 206/892-0361

**OREGON (continued)**

**William J. Purdy Company**  
7799 Southwest Cirrus Drive  
Beaverton 97005 — 5945  
Tel. 503/641-9373

**PENNSYLVANIA**

**Trinkle Sales Inc.**  
P.O. Box 5320  
Cherry Hill, NJ 08034 — 0460  
Tel. Phila. 215/922-2080

**SOUTH CAROLINA**

**Electronic Marketing Associates**  
210 W. Stone Ave.  
Greenville 29609 — 5499  
Tel. 803/233-4637

**TENNESSEE (Eastern)**

**Electronic Marketing Associates**  
9225 Honeycutt Creek Road  
Raleigh, NC 27609 — 1523  
Tel. 919/847-8800

**(Western)**

**EPI Inc.**  
Suite 13 — 9694 Hwy. 20 W  
Madison, AL 35758  
Tel. 205/461-7000

**TEXAS**

**Sprague Electric Company**  
Suite 220  
9319 LBJ Freeway  
Dallas 75243 — 3403  
Tel. 214/235-1256

**Sprague Electric Company**  
Suite 350W — 1106 Clayton Lane  
Austin 78723 — 1033  
Tel. 512/458-2514

**UTAH**

**William J. Purdy Company**  
5570 E. Yale Avenue  
Denver, CO 80222 — 6907  
Tel. 303/753-6800

**VIRGINIA**

**Sprague Electric Company**  
1 East Preston St.  
Lexington 24450 — 2324  
Tel. 703/463-9161

**Sprague Electric Company**

Suite 311  
14333 Laurel-Bowie Road  
Laurel, MD 20708 — 1130  
Tel. 301/953-1717

**Trinkle Sales Inc.**

P.O. Box 5320  
Cherry Hill, NJ 08034 — 0460  
Tel. 609/795-4200

**WASHINGTON**

**Sprague Electric Company**  
3826 Woodland Park, North  
Seattle 98103 — 7996  
Tel. 206/632-7761

**Sprague Electric Company**

Suite H  
16111 S.E. McGillivray Blvd.  
Vancouver 98664  
Tel. 206/892-0361  
Tel. 503/225-0493

**William J. Purdy Company**

4082-148th Ave. N.E.  
Redmond 98052 — 5165  
Tel. 206/882-3144

**WISCONSIN**

**D. Dolin Sales**  
131 West Layton Ave.  
Milwaukee 53207 — 5991  
Tel. 414/482-1111

**CANADA**

**Sprague Electric of Canada, Ltd.**  
Suite 220  
2375 Steeles Avenue, W.  
Downsview, Ontario M3J 3A8  
Tel. 416/665-6066

**CANADA (continued)**

**Sprague Electric of Canada, Ltd.**  
Suite 1610 — 85 Albert St.  
Ottawa, Ont. K1P 6A4  
Tel. 613/238-2542

**Lenbrook Electronics**

Suite No. 2  
13696 104th Ave.  
Surrey, B.C. V3T1W4  
Tel. 604/585-9599

**EUROPE**

**Sprague World Trade Corp.**  
18 Avenue Louis Casai  
1209-Geneva  
Switzerland  
Tel. 98-4021  
TLX 845-23469

**Sprague Benelux**

Excelsiorlaan 21  
Bus 3  
1930 Zaventem  
Belgium  
Tel. 02/721.48.60  
TLX 62897

**Sprague Electric (U.K.) Ltd.**

Airtech No. 2  
Fleming Way  
Crawley West Sussex RH 102 YQ  
England  
Tel. 011-44-293-51-78-78  
TLX 877813

**Sprague France S.A.R.L.**

3 Rue Camille Desmoulins  
9430 Cachan  
France  
Tel. (1) 547-6600  
TLX 250697

**Sprague Elektronik GmbH**

Postfach 700 848  
D-6 Frankfurt/M  
West Germany  
Tel. 069-60551  
TLX 414008

**Sprague Italiana S.p.A.**

Via G. DeCastro 4  
20144 Milano  
Italy  
Tel. 02-498-7891  
TLX 332321

**Sprague Scandinavia AB**

Box 54  
S-182 71 Stocksund  
Sweden  
Tel. (04.) 08-8502 20  
TLX 854 15239

**FAR EAST**
**Sprague World Trade Corp.**

Eastern Branch  
G.P.O. Box 4289  
Hong Kong  
Tel. 0-283188  
TLX 43395

**Sprague Japan K.K.**

Shinjuku KB Bldg.  
11-3, Nishi-Shinjuku 6-Chome  
Shinjuku-ku, Tokyo 160  
Japan  
Tel. (03) 348-5221  
TLX J23328

**Tecnomil Ltd.**

Sprague Korea Branch  
4th Fl., Daiyoung Bldg.,  
44-1, Yoido-Dong  
Youngdungpo-Ku, Seoul, Korea  
Tel. (2) 783-9784  
TLX 78726186

**Sprague World Trade Corp.**

Singapore Office  
11th Floor, 450/452 Incheape House  
Alexandra Road  
Singapore 0511  
Tel. 475-1826  
TLX RS 26384

**Sprague Taiwan Branch/**

**Tecnomil, Ltd.**  
8/F, 142, Sec. 4  
Chung Hsiao East Road  
Taipei, Taiwan, R.O.C.  
Tel. 771-9582  
TLX 21422

In the construction of the components described, the full intent of the specification will be met. The Sprague Electric Company, however, reserves the right to make, from time to time, such departures from the detail specifications as may be required to permit improvements in the design of its products. Components made under military approvals will be in accordance with the approval requirements.

The information included herein is believed to be accurate and reliable. However, the Sprague Electric Company assumes no responsibility for its use; nor for any infringements of patents or other rights which may result from its use.

**8217**  
**8439**