

- Qualified for Automotive Applications
- ESD Protection Exceeds 200 V Using Machine Model (C = 200 pF, R = 0)
- 100- $\mu$ A Typical Starting Supply Current
- 500- $\mu$ A Typical Operating Supply Current
- Operation to 1 MHz
- Internal Soft Start
- Internal Fault Soft Start
- Internal Leading-Edge Blanking of the Current Sense Signal
- 1-A Totem-Pole Output
- 70-ns Typical Response From Current-Sense to Gate Drive Output
- 1.5% Tolerance Voltage Reference
- Same Pinout as UC3802, UC3842, and UC3842A

## description

The UCC2813-0/-1/-2/-3/-4/-5 family of high-speed low-power integrated circuits contain all of the control and drive components required for off-line and dc-to-dc fixed-frequency current-mode switching power supplies with minimal parts count.

These devices have the same pin configuration as the UC2842/3/4/5 family and also offer the added features of internal full-cycle soft start and internal leading-edge blanking of the current-sense input.

The UCC2813-0/-1/-2/-3/-4/-5 family offers choice of maximum duty cycle and critical voltage levels. Lower reference parts, such as the UCC2813-3 and UCC2813-5, fit best into battery-operated systems, while the higher reference and the higher undervoltage lockout (UVLO) hysteresis of the UCC2813-2 and UCC2813-4 make these ideal choices for use in off-line power supplies.

The UCC2813-x series is specified for the automotive temperature range of  $-40^{\circ}\text{C}$  to  $125^{\circ}\text{C}$ .

PART NUMBER	MAXIMUM DUTY CYCLE	REFERENCE VOLTAGE	TURN-ON THRESHOLD	TURN-OFF THRESHOLD
UCC2813-0	100%	5 V	7.2 V	6.9 V
UCC2813-1	50%	5 V	9.4 V	7.4 V
UCC2813-2	100%	5 V	12.5 V	8.3 V
UCC2813-3	100%	4 V	4.1 V	3.6 V
UCC2813-4	50%	5 V	12.5 V	8.3 V
UCC2813-5	50%	4 V	4.1 V	3.6 V



Please be aware that an important notice concerning availability, standard warranty, and use in critical applications of Texas Instruments semiconductor products and disclaimers thereto appears at the end of this data sheet.

PRODUCTION DATA information is current as of publication date. Products conform to specifications per the terms of Texas Instruments standard warranty. Production processing does not necessarily include testing of all parameters.



# UCC2813-0/-1/-2/-3/-4/-5-Q1

## LOW-POWER BICMOS CURRENT-MODE PWM

SGLS245D – MAY 2004 – REVISED APRIL 2008

### block diagram

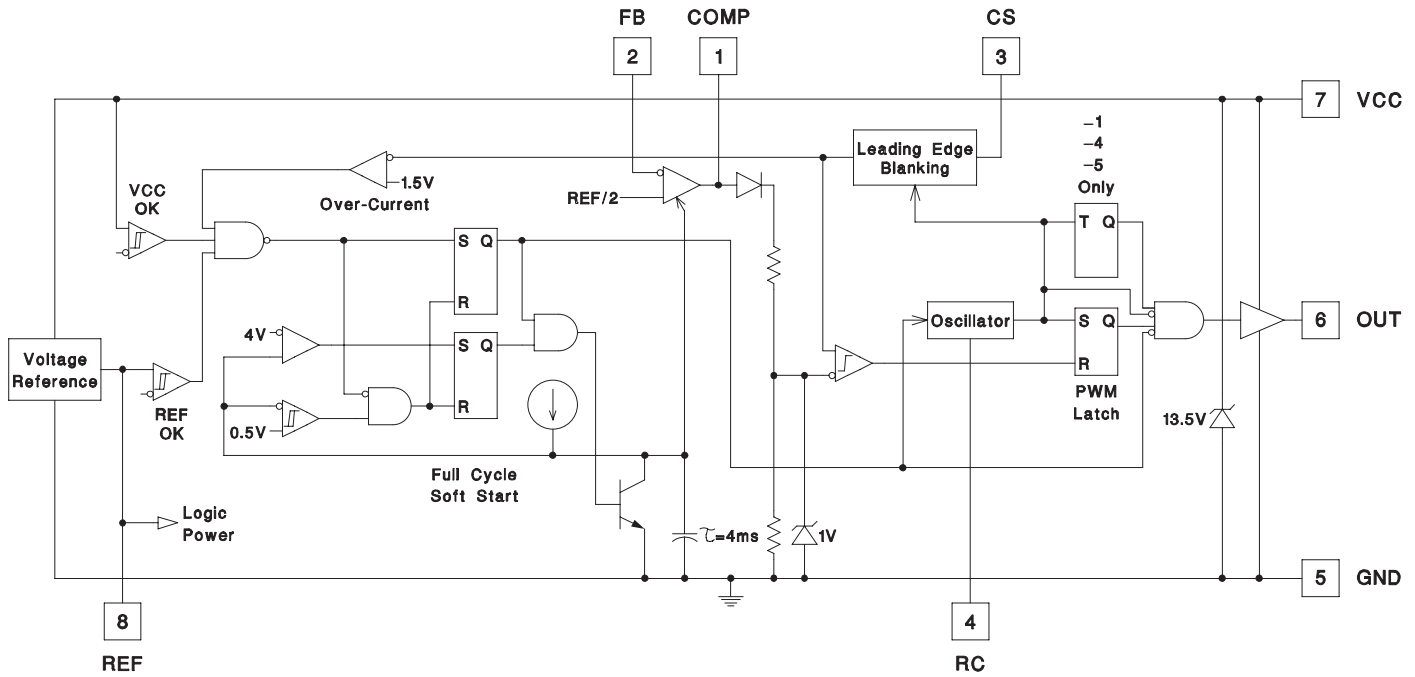

### AVAILABLE OPTIONS†‡

T <sub>A</sub>	ORDERABLE PART NUMBER
-40°C to 125°C	UCC2813QDR-0Q1
	UCC2813QDR-1Q1
	UCC2813QDR-2Q1
	UCC2813QDR-3Q1
	UCC2813QDR-4Q1
	UCC2813QDR-5Q1
	UCC2813QPWR-3Q1

† For the most current package and ordering information, see the Package Option Addendum at the end of this document, or see the TI web site at [www.ti.com](http://www.ti.com).

‡ Package drawings, thermal data, and symbolization are available at [www.ti.com/packaging](http://www.ti.com/packaging).

### D PACKAGE (TOP VIEW)

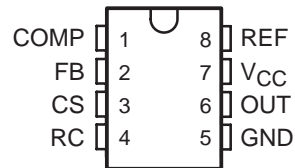

### TSSOP-8 PW PACKAGE (TOP VIEW)



# UCC2813-0/-1/-2/-3/-4/-5-Q1

## LOW-POWER BICMOS CURRENT-MODE PWM

SGLS245D – MAY 2004 – REVISED APRIL 2008

### ordering information

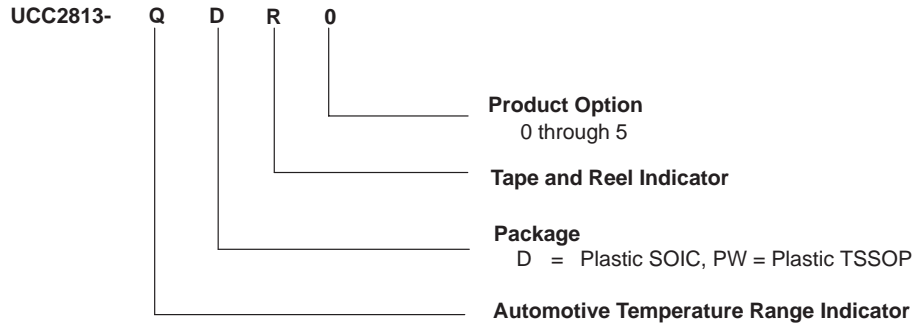

### absolute maximum ratings over operating free-air temperature range (unless otherwise noted)<sup>†‡</sup>

$V_{CC}$ voltage §	12 V
$V_{CC}$ current §	30 mA
Output current, $I_O$	$\pm 1$ A
Output energy (capacitive load)	20 $\mu$ J
Analog inputs (FB, CS)	-0.3 V to 6.3 V
Power dissipation at $T_A < +25^\circ\text{C}$ (D package)	0.65 W
Storage temperature range, $T_{stg}$	-65°C to 150°C
Lead temperature soldering 1,6 mm (1/16 inch) from case for 10 seconds	300°C

<sup>†</sup> Stresses beyond those listed under “absolute maximum ratings” may cause permanent damage to the device. These are stress ratings only, and functional operation of the device at these or any other conditions beyond those indicated under “recommended operating conditions” is not implied. Exposure to absolute-maximum-rated conditions for extended periods may affect device reliability.

<sup>‡</sup> Unless otherwise indicated, voltages are reference to ground and currents are positive into and negative out of the specified terminals.

§ In normal operation  $V_{CC}$  is powered through a current limiting resistor. Absolute maximum of 12 V applies when  $V_{CC}$  is driven from a low impedance source such that  $I_{CC}$  does not exceed 30 mA (which includes gate drive current requirement).

### electrical characteristics $T_A = -40^\circ\text{C}$ to $125^\circ\text{C}$ , $V_{CC} = 10$ V (see Note 1), $R_T = 100$ k $\Omega$ from REF to RC, $C_T = 330$ pF from RC to GND, 0.1-F capacitor from $V_{CC}$ to GND, 0.1-F capacitor from $V_{REF}$ to GND, and $T_A = T_J$ (unless otherwise noted)

PARAMETER	TEST CONDITIONS	MIN	TYP	MAX	UNIT	
<b>Reference Section</b>						
Output voltage	$T_J = 25^\circ\text{C}$ , $I = 0.2$ mA	UCC2813-0/-1/-2/-4	4.925	5	5.075	V
		UCC2813-3/-5	3.94	4	4.06	
Load regulation voltage	$I = 0.2$ mA to 5 mA		10	30	mV	
Total variation voltage	See Note 5	UCC2813-0/-1/-2/-4	4.84	5	5.1	V
		UCC2813-3/-5	3.84	4	4.08	
Output noise voltage	$f = 10$ Hz to 10 kHz, See Note 7		70		$\mu$ V	
Long term stability	1000 hours, See Note 7		5		mV	
Output short-circuit current		-5		-35	mA	



# UCC2813-0/-1/-2/-3/-4/-5-Q1

## LOW-POWER BICMOS CURRENT-MODE PWM

SGLS245D – MAY 2004 – REVISED APRIL 2008

electrical characteristics  $T_A = -40^\circ\text{C}$  to  $125^\circ\text{C}$ ,  $V_{CC} = 10\text{ V}$  (see Note 1),  $R_T = 100\text{ k}\Omega$  from REF to RC,  $C_T = 330\text{ pF}$  from RC to GND, 0.1 F capacitor from  $V_{CC}$  to GND, 0.1 F capacitor from  $V_{REF}$  to GND and  $T_A = T_J$  (unless otherwise noted)

PARAMETER	TEST CONDITIONS		MIN	TYP	MAX	UNIT
<b>Oscillator Section</b>						
Oscillator frequency	See Note 2	UCC2813-0/-1/-2/-4	40	46	52	kHz
		UCC2813-3/-5	26	31	36	
Temperature stability	See Note 7		2.5			%
Amplitude, peak to peak			2.25	2.4	2.55	V
Oscillator peak voltage			2.45			V
<b>Error Amplifier Section</b>						
Input voltage	COMP = 2.5 V	UCC2813-0/-1/-2/-4	2.42	2.5	2.56	V
	COMP = 2.0 V	UCC2813-3/-5	1.92	2	2.05	
Input bias current			-2		2	$\mu\text{A}$
Open loop voltage gain			60	80		dB
COMP sink current	FB = 2.7 V,	COMP = 1.1 V	0.3		3.5	mA
COMP source current	FB = 1.8 V,	COMP = REF - 1.2 V	-0.2	-0.5	-0.8	mA
Gain bandwidth product	See Note 7		2			MHz
<b>PWM Section</b>						
Maximum duty cycle		UCC2813-0/-2/-3	97	99	100	%
		UCC2813-1/-4/-5	48	49	50	
Minimum duty cycle	COMP = 0 V		0			%
<b>Current Sense Section</b>						
Gain	See Note 3		1.1	1.65	1.8	V/V
Maximum input signal	COMP = 5 V,	See Note 4	0.9	1	1.1	V
Input bias current			-200		200	nA
CS blank time			50	100	150	ns
Over-current threshold voltage			1.32	1.55	1.7	V
COMP to CS offset voltage	CS = 0 V		0.45	0.9	1.35	V
<b>Output Section (OUT)</b>						
Low-level output voltage	$I_{OUT} = 20\text{ mA}$	All parts	0.1 0.4			V
	$I_{OUT} = 200\text{ mA}$	All parts	0.35 0.9			
	$I_{OUT} = 50\text{ mA}, V_{CC} = 5\text{ V}$	UCC2813-3/-5	0.15 0.4			
	$I_{OUT} = 20\text{ mA}, V_{CC} = 0\text{ V}$	All parts	0.7 1.2			
High-level output voltage, $V_{SAT} (V_{CC} - OUT)$	$I_{OUT} = -20\text{ mA}$	All parts	0.15 0.4			V
	$I_{OUT} = -200\text{ mA}$	All parts	1 1.9			
	$I_{OUT} = -50\text{ mA}, V_{CC} = 5\text{ V}$	UCC2813-3/-5	0.4 0.9			
Rise time	$C_L = 1\text{ nF}$		41 70			ns
Fall time	$C_L = 1\text{ nF}$		44 75			ns



# UCC2813-0/-1/-2/-3/-4/-5-Q1

## LOW-POWER BICMOS CURRENT-MODE PWM

SGLS245D – MAY 2004 – REVISED APRIL 2008

electrical characteristics  $T_A = -40^\circ\text{C}$  to  $125^\circ\text{C}$ ,  $V_{CC} = 10\text{ V}$  (see Note 1),  $R_T = 100\text{ k}\Omega$  from REF to RC,  $C_T = 330\text{ pF}$  from RC to GND,  $0.1\text{ F}$  capacitor from  $V_{CC}$  to GND,  $0.1\text{ F}$  capacitor from  $V_{REF}$  to GND, and  $T_A = T_J$  (unless otherwise noted)

PARAMETER	TEST CONDITIONS		MIN	TYP	MAX	UNIT
<b>Undervoltage Lockout Section</b>						
Start threshold	See Note 6	UCC2813-0	6.6	7.2	7.8	V
		UCC2813-1	8.6	9.4	10.2	
		UCC2813-2/-4	11.5	12.5	13.5	
		UCC2813-3/-5	3.7	4.1	4.5	
Stop threshold	See Note 6	UCC2813-0	6.3	6.9	7.5	V
		UCC2813-1	6.8	7.4	8	
		UCC2813-2/-4	7.6	8.3	9	
		UCC2813-3/-5	3.2	3.6	4	
Start to stop hysteresis		UCC2813-0	0.12	0.3	0.48	V
		UCC2813-1	1.6	2	2.4	
		UCC2813-2/-4	3.5	4.2	5.1	
		UCC2813-3/-5	0.2	0.5	0.8	
<b>Soft-Start Section</b>						
COMP rise time	FB = 1.8 V,	Rise from 0.5 V to REF – 1 V		4	10	ms
<b>Overall</b>						
Start-up current	$V_{CC} < \text{Start hreshold}$			0.1	0.23	mA
Operating supply current	FB = 0 V,	CS = 0 V, RC = 0 V		0.5	1.2	mA
$V_{CC}$ internal zener voltage	$I_{CC} = 10\text{ mA}$ ,	See Notes 6 and 8	12	13.5	15	V
$V_{CC}$ internal zener voltage minus start threshold voltage	See Note 6	UCC2813-2/-4	0.5	1.0		V

- NOTES:
- Adjust  $V_{CC}$  above the start threshold before setting at 10 V.
  - Oscillator frequency for the UCC2813-0, UCC2813-2, and UCC2813-3 is the output frequency. Oscillator frequency for the UCC2813-1, UCC2813-4, and UCC2813-5 is twice the output frequency.
  - Gain is defined by:  $A = \frac{\Delta V_{COMP}}{\Delta V_{CS}}$   $0 \leq V_{CS} \leq 0.8\text{ V}$ .
  - Parameter measured at trip point of latch with pin 2 at 0 V.
  - Total variation includes temperature stability and load regulation.
  - Start threshold, stop threshold, and Zener shunt thresholds track one another.
  - Not production tested
  - The device is fully operating in clamp mode as the forcing current is higher than the normal operating supply current.



# UCC2813-0/-1/-2/-3/-4/-5-Q1

## LOW-POWER BICMOS CURRENT-MODE PWM

SGLS245D – MAY 2004 – REVISED APRIL 2008

---

### detailed terminal descriptions

#### COMP

COMP is the output of the error amplifier and the input of the PWM comparator.

Unlike other devices, the error amplifier in the UCC2813 family is a true, low output-impedance, 2-MHz operational amplifier. As such, the COMP terminal can both source and sink current. However, the error amplifier is internally current limited, so that one can command zero duty cycle by externally forcing COMP to GND.

The UCC2813 family features built-in full-cycle soft start. Soft start is implemented as a clamp on the maximum COMP voltage.

#### CS

CS is the input to the current sense comparators. The UCC2813 family has two different current sense comparators: the PWM comparator and an overcurrent comparator.

The UCC2813 family contains digital current sense filtering, which disconnects the CS terminal from the current sense comparator during the 100 ns interval immediately following the rising edge of the OUT pin. This digital filtering, also called leading-edge blanking, means that in most applications, no analog filtering (RC filter) is required on CS. Compared to an external RC filter technique, the leading-edge blanking provides a smaller effective CS to OUT propagation delay. Note, however, that the minimum non-zero on time of the OUT signal is directly affected by the leading-edge blanking and the CS to OUT propagation delay.

The overcurrent comparator is only intended for fault sensing, and exceeding the overcurrent threshold causes a soft start cycle.

#### FB

FB is the inverting input of the error amplifier. For best stability, keep FB lead length as short as possible and FB stray capacitance as small as possible.

#### GND

GND is reference ground and power ground for all functions on this part.

#### OUT

OUT is the output of a high-current power driver capable of driving the gate of a power MOSFET with peak currents exceeding  $\pm 750$  mA. OUT is actively held low when  $V_{CC}$  is below the UVLO threshold.

The high-current power driver consists of FET output devices, which can switch all of the way to GND and all of the way to  $V_{CC}$ . The output stage also provides a low impedance to overshoot and undershoot. This means that, in many cases, external Schottky clamp diodes are not required.



---

**detailed descriptions (continued)**

**RC**

RC is the oscillator timing pin. For fixed frequency operation, set timing capacitor charging current by connecting a resistor from REF to RC. Set frequency by connecting timing capacitor from RC to GND. For best performance, keep the timing capacitor lead to GND as short and direct as possible. If possible, use separate ground traces for the timing capacitor and all other functions.

The frequency of oscillation can be estimated with the following equations:

$$\text{UCC2813-0/1/2/4: } F = \frac{1.5}{R \times C}$$

$$\text{UCC2813-3/UCC2813-5: } F = \frac{1.0}{R \times C}$$

(1)

where frequency is in Hz, resistance is in ohms, and capacitance is in farads. The recommended range of the timing resistors is between 10 k $\Omega$  and 200 k $\Omega$  and the timing capacitor is 100 pF to 1000 pF. Never use a timing resistor less than 10 k.

To prevent noise problems, bypass  $V_{CC}$  to GND with a ceramic capacitor as close to the  $V_{CC}$  pin as possible. An electrolytic capacitor may also be used in addition to the ceramic capacitor.

**voltage reference (REF)**

REF is the voltage reference for the error amplifier and also for many other functions on the IC. REF is also used as the logic power supply for high-speed switching logic on the IC.

When  $V_{CC}$  is greater than 1 V and less than the UVLO threshold, REF is pulled to ground through a 5-k $\Omega$  resistor. This means that REF can be used as a logic output indicating power system status. It is important for reference stability that REF is bypassed to GND with a ceramic capacitor as close to the pin as possible. An electrolytic capacitor may also be used in addition to the ceramic capacitor. A minimum of 0.1- $\mu$ F ceramic capacitor is required. Additional REF bypassing is required for external loads greater than 2.5 mA on the reference.

To prevent noise problems with high-speed switching transients, bypass REF to ground with a ceramic capacitor close to the IC package.

**power ( $V_{CC}$ )**

$V_{CC}$  is the power input connection for this device. In normal operation,  $V_{CC}$  is powered through a current-limiting resistor. Although quiescent  $V_{CC}$  current is low, total supply current will be higher, depending on OUT current. Total  $V_{CC}$  current is the sum of quiescent  $V_{CC}$  current and the average OUT current. Knowing the operating frequency and the MOSFET gate charge ( $Q_g$ ), average OUT current can be calculated from:

$$I_{OUT} = Q_g \times F.$$

(2)

# UCC2813-0/-1/-2/-3/-4/-5-Q1

## LOW-POWER BICMOS CURRENT-MODE PWM

SGLS245D – MAY 2004 – REVISED APRIL 2008

### PARAMETER MEASUREMENT INFORMATION

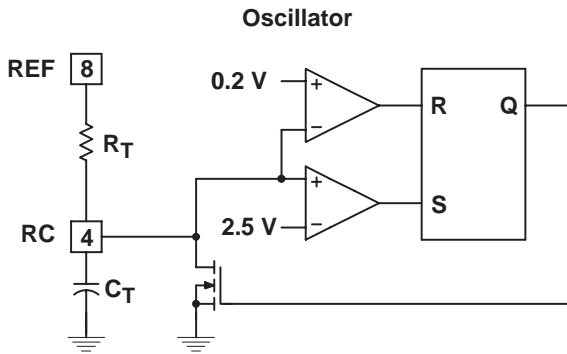

The UCC2813-0/-1/-2/-3/-4/-5 oscillator generates a sawtooth waveform on RC. The rise time is set by the time constant of  $R_T$  and  $C_T$ . The fall time is set by  $C_T$  and an internal transistor on-resistance of approximately 125. During the fall time, the output is off and the maximum duty cycle is reduced below 50% or 100% depending on the part number. Larger timing capacitors increase the discharge time and reduce the maximum duty cycle and frequency.

Figure 1

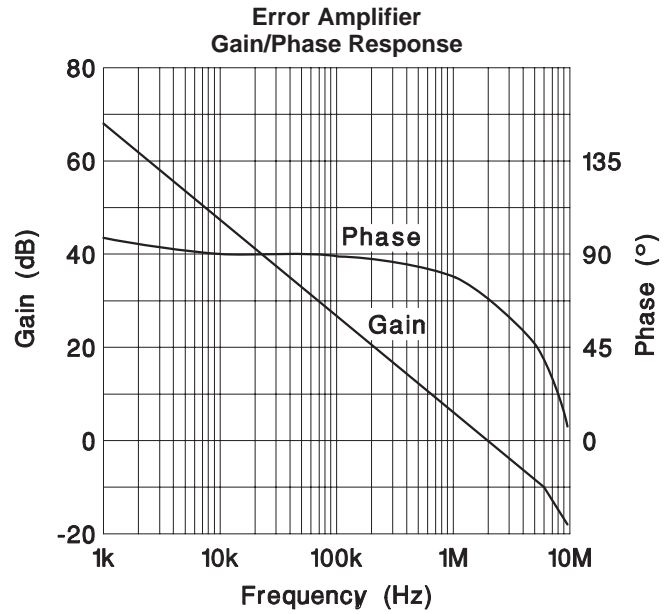

Figure 2

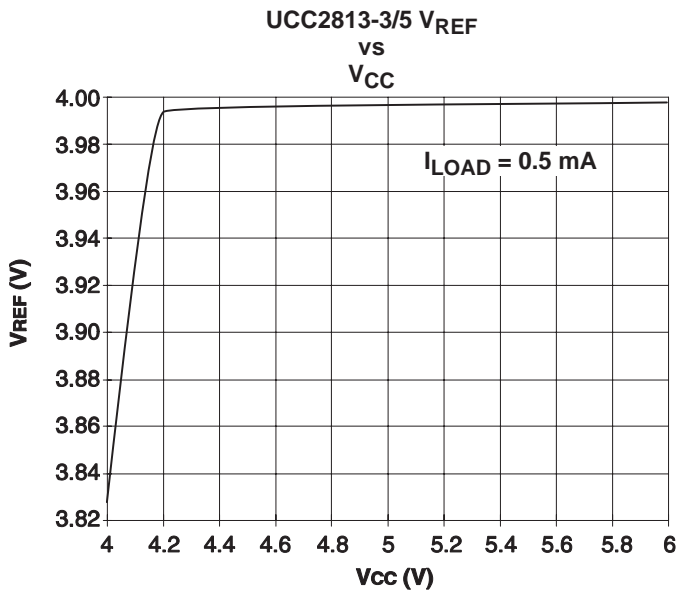

Figure 3

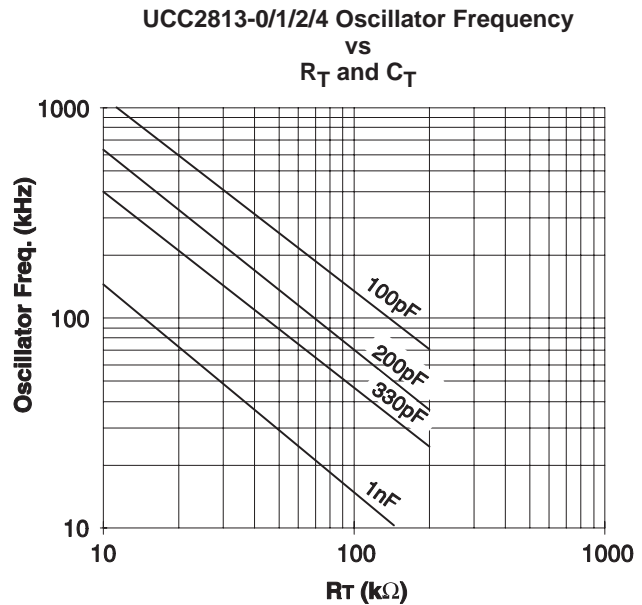

Figure 4



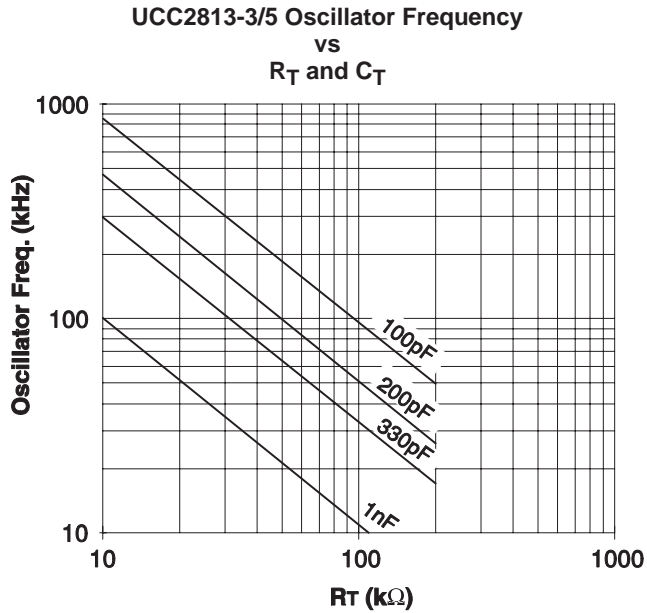

Figure 5

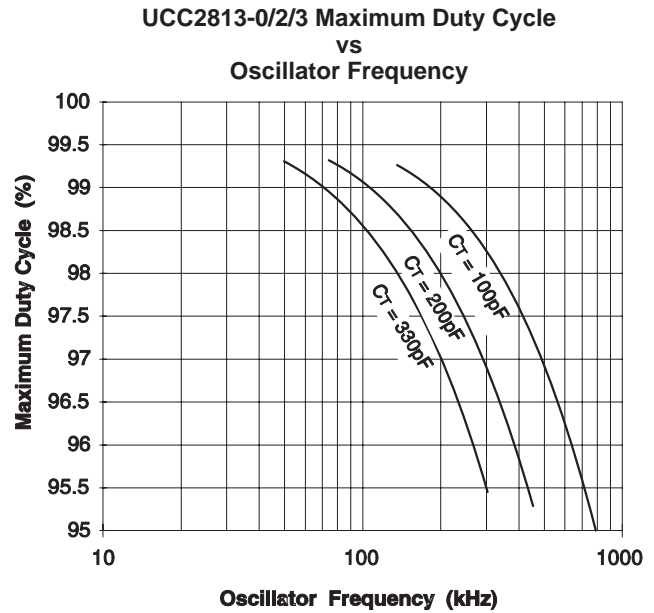

Figure 6

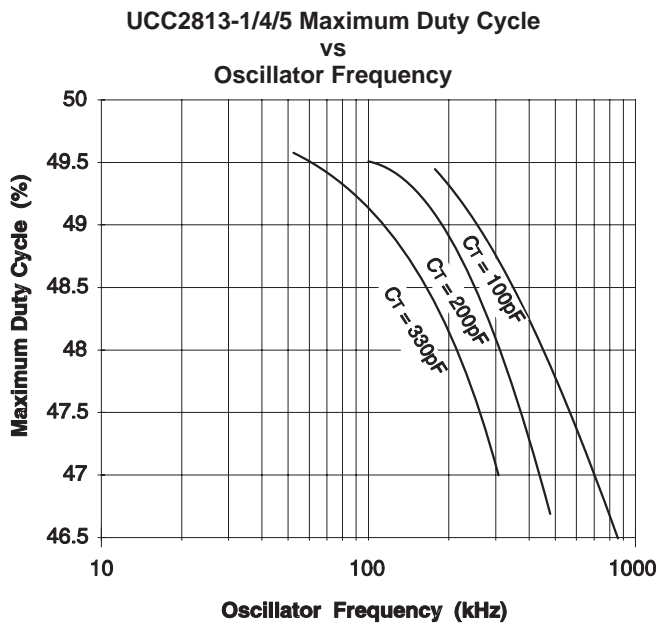

Figure 7

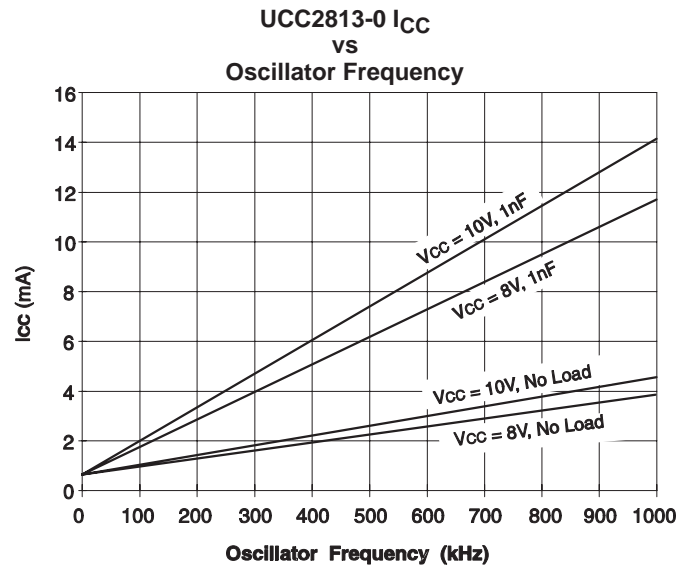

Figure 8

# UCC2813-0/-1/-2/-3/-4/-5-Q1 LOW-POWER BICMOS CURRENT-MODE PWM

SGLS245D – MAY 2004 – REVISED APRIL 2008

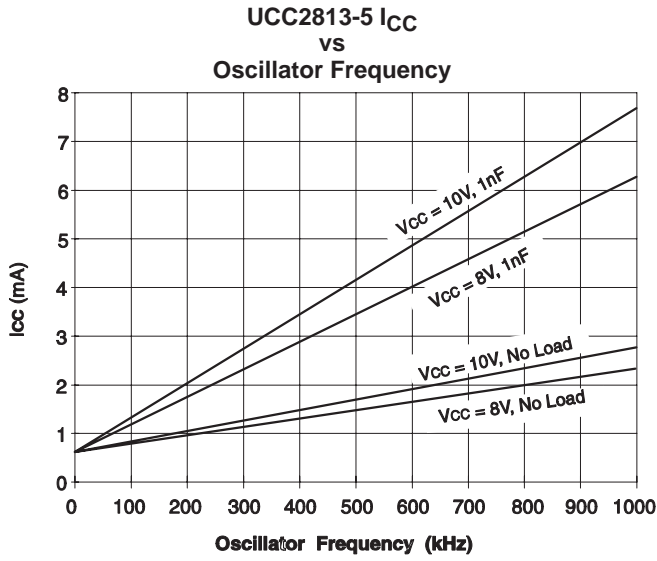

Figure 9

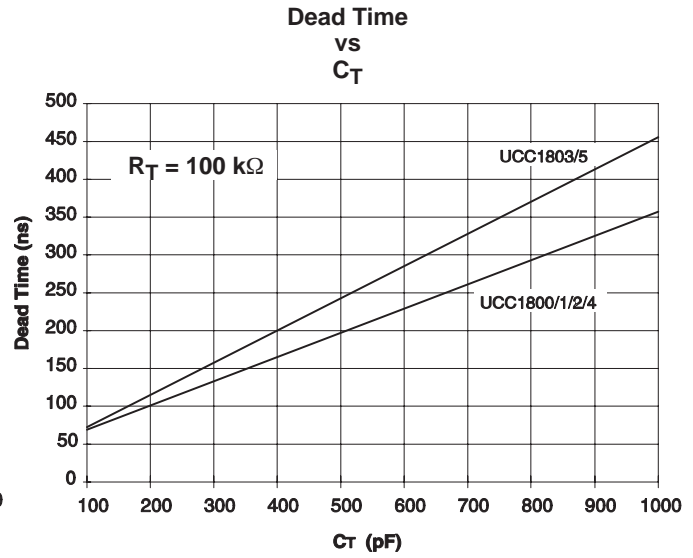

Figure 10

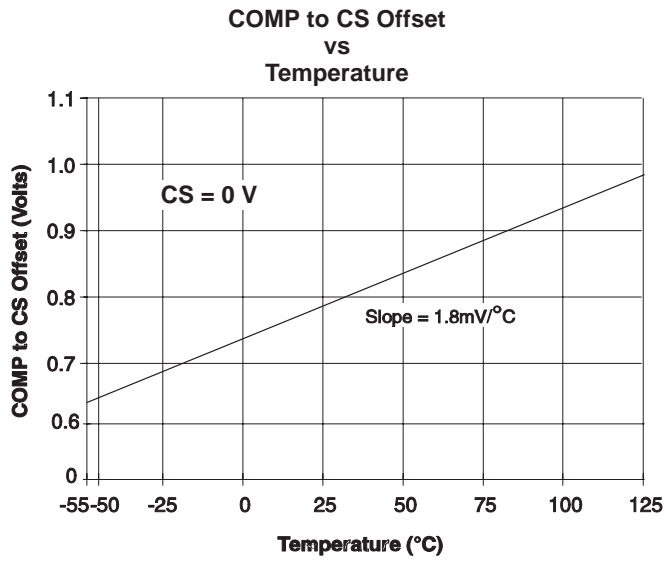

Figure 11

**PACKAGING INFORMATION**

Orderable Device	Status <sup>(1)</sup>	Package Type	Package Drawing	Pins	Package Qty	Eco Plan <sup>(2)</sup>	Lead/ Ball Finish	MSL Peak Temp <sup>(3)</sup>	Samples (Requires Login)
UCC2813QDR-0Q1	ACTIVE	SOIC	D	8	2500	Green (RoHS & no Sb/Br)	CU NIPDAU	Level-1-260C-UNLIM	
UCC2813QDR-1Q1	ACTIVE	SOIC	D	8	2500	Green (RoHS & no Sb/Br)	CU NIPDAU	Level-1-260C-UNLIM	
UCC2813QDR-2Q1	ACTIVE	SOIC	D	8	2500	Green (RoHS & no Sb/Br)	CU NIPDAU	Level-1-260C-UNLIM	
UCC2813QDR-3Q1	ACTIVE	SOIC	D	8	2500	Green (RoHS & no Sb/Br)	CU NIPDAU	Level-1-260C-UNLIM	
UCC2813QDR-4Q1	ACTIVE	SOIC	D	8	2500	Green (RoHS & no Sb/Br)	CU NIPDAU	Level-1-260C-UNLIM	
UCC2813QDR-5Q1	ACTIVE	SOIC	D	8	2500	Green (RoHS & no Sb/Br)	CU NIPDAU	Level-1-260C-UNLIM	
UCC2813QPWR-3Q1	ACTIVE	TSSOP	PW	8	2000	Green (RoHS & no Sb/Br)	CU NIPDAU	Level-1-260C-UNLIM	

<sup>(1)</sup> The marketing status values are defined as follows:

**ACTIVE:** Product device recommended for new designs.

**LIFEBUY:** TI has announced that the device will be discontinued, and a lifetime-buy period is in effect.

**NRND:** Not recommended for new designs. Device is in production to support existing customers, but TI does not recommend using this part in a new design.

**PREVIEW:** Device has been announced but is not in production. Samples may or may not be available.

**OBSOLETE:** TI has discontinued the production of the device.

<sup>(2)</sup> Eco Plan - The planned eco-friendly classification: Pb-Free (RoHS), Pb-Free (RoHS Exempt), or Green (RoHS & no Sb/Br) - please check <http://www.ti.com/productcontent> for the latest availability information and additional product content details.

**TBD:** The Pb-Free/Green conversion plan has not been defined.

**Pb-Free (RoHS):** TI's terms "Lead-Free" or "Pb-Free" mean semiconductor products that are compatible with the current RoHS requirements for all 6 substances, including the requirement that lead not exceed 0.1% by weight in homogeneous materials. Where designed to be soldered at high temperatures, TI Pb-Free products are suitable for use in specified lead-free processes.

**Pb-Free (RoHS Exempt):** This component has a RoHS exemption for either 1) lead-based flip-chip solder bumps used between the die and package, or 2) lead-based die adhesive used between the die and leadframe. The component is otherwise considered Pb-Free (RoHS compatible) as defined above.

**Green (RoHS & no Sb/Br):** TI defines "Green" to mean Pb-Free (RoHS compatible), and free of Bromine (Br) and Antimony (Sb) based flame retardants (Br or Sb do not exceed 0.1% by weight in homogeneous material)

<sup>(3)</sup> MSL, Peak Temp. -- The Moisture Sensitivity Level rating according to the JEDEC industry standard classifications, and peak solder temperature.

**Important Information and Disclaimer:** The information provided on this page represents TI's knowledge and belief as of the date that it is provided. TI bases its knowledge and belief on information provided by third parties, and makes no representation or warranty as to the accuracy of such information. Efforts are underway to better integrate information from third parties. TI has taken and

continues to take reasonable steps to provide representative and accurate information but may not have conducted destructive testing or chemical analysis on incoming materials and chemicals. TI and TI suppliers consider certain information to be proprietary, and thus CAS numbers and other limited information may not be available for release.

In no event shall TI's liability arising out of such information exceed the total purchase price of the TI part(s) at issue in this document sold by TI to Customer on an annual basis.

**OTHER QUALIFIED VERSIONS OF UCC2813-0-Q1, UCC2813-1-Q1, UCC2813-2-Q1, UCC2813-3-Q1, UCC2813-4-Q1, UCC2813-5-Q1 :**

- Catalog: [UCC2813-0](#), [UCC2813-1](#), [UCC2813-2](#), [UCC2813-3](#), [UCC2813-4](#), [UCC2813-5](#)

NOTE: Qualified Version Definitions:

- Catalog - TI's standard catalog product

D (R-PDSO-G8)

PLASTIC SMALL OUTLINE



NOTES: A. All linear dimensions are in inches (millimeters).  
 B. This drawing is subject to change without notice.  
 C. Body length does not include mold flash, protrusions, or gate burrs. Mold flash, protrusions, or gate burrs shall not exceed 0.006 (0,15) each side.  
 D. Body width does not include interlead flash. Interlead flash shall not exceed 0.017 (0,43) each side.  
 E. Reference JEDEC MS-012 variation AA.



## IMPORTANT NOTICE

Texas Instruments Incorporated and its subsidiaries (TI) reserve the right to make corrections, modifications, enhancements, improvements, and other changes to its products and services at any time and to discontinue any product or service without notice. Customers should obtain the latest relevant information before placing orders and should verify that such information is current and complete. All products are sold subject to TI's terms and conditions of sale supplied at the time of order acknowledgment.

TI warrants performance of its hardware products to the specifications applicable at the time of sale in accordance with TI's standard warranty. Testing and other quality control techniques are used to the extent TI deems necessary to support this warranty. Except where mandated by government requirements, testing of all parameters of each product is not necessarily performed.

TI assumes no liability for applications assistance or customer product design. Customers are responsible for their products and applications using TI components. To minimize the risks associated with customer products and applications, customers should provide adequate design and operating safeguards.

TI does not warrant or represent that any license, either express or implied, is granted under any TI patent right, copyright, mask work right, or other TI intellectual property right relating to any combination, machine, or process in which TI products or services are used. Information published by TI regarding third-party products or services does not constitute a license from TI to use such products or services or a warranty or endorsement thereof. Use of such information may require a license from a third party under the patents or other intellectual property of the third party, or a license from TI under the patents or other intellectual property of TI.

Reproduction of TI information in TI data books or data sheets is permissible only if reproduction is without alteration and is accompanied by all associated warranties, conditions, limitations, and notices. Reproduction of this information with alteration is an unfair and deceptive business practice. TI is not responsible or liable for such altered documentation. Information of third parties may be subject to additional restrictions.

Resale of TI products or services with statements different from or beyond the parameters stated by TI for that product or service voids all express and any implied warranties for the associated TI product or service and is an unfair and deceptive business practice. TI is not responsible or liable for any such statements.

TI products are not authorized for use in safety-critical applications (such as life support) where a failure of the TI product would reasonably be expected to cause severe personal injury or death, unless officers of the parties have executed an agreement specifically governing such use. Buyers represent that they have all necessary expertise in the safety and regulatory ramifications of their applications, and acknowledge and agree that they are solely responsible for all legal, regulatory and safety-related requirements concerning their products and any use of TI products in such safety-critical applications, notwithstanding any applications-related information or support that may be provided by TI. Further, Buyers must fully indemnify TI and its representatives against any damages arising out of the use of TI products in such safety-critical applications.

TI products are neither designed nor intended for use in military/aerospace applications or environments unless the TI products are specifically designated by TI as military-grade or "enhanced plastic." Only products designated by TI as military-grade meet military specifications. Buyers acknowledge and agree that any such use of TI products which TI has not designated as military-grade is solely at the Buyer's risk, and that they are solely responsible for compliance with all legal and regulatory requirements in connection with such use.

TI products are neither designed nor intended for use in automotive applications or environments unless the specific TI products are designated by TI as compliant with ISO/TS 16949 requirements. Buyers acknowledge and agree that, if they use any non-designated products in automotive applications, TI will not be responsible for any failure to meet such requirements.

Following are URLs where you can obtain information on other Texas Instruments products and application solutions:

### Products

Audio	<a href="http://www.ti.com/audio">www.ti.com/audio</a>
Amplifiers	<a href="http://amplifier.ti.com">amplifier.ti.com</a>
Data Converters	<a href="http://dataconverter.ti.com">dataconverter.ti.com</a>
DLP® Products	<a href="http://www.dlp.com">www.dlp.com</a>
DSP	<a href="http://dsp.ti.com">dsp.ti.com</a>
Clocks and Timers	<a href="http://www.ti.com/clocks">www.ti.com/clocks</a>
Interface	<a href="http://interface.ti.com">interface.ti.com</a>
Logic	<a href="http://logic.ti.com">logic.ti.com</a>
Power Mgmt	<a href="http://power.ti.com">power.ti.com</a>
Microcontrollers	<a href="http://microcontroller.ti.com">microcontroller.ti.com</a>
RFID	<a href="http://www.ti-rfid.com">www.ti-rfid.com</a>
OMAP Mobile Processors	<a href="http://www.ti.com/omap">www.ti.com/omap</a>
Wireless Connectivity	<a href="http://www.ti.com/wirelessconnectivity">www.ti.com/wirelessconnectivity</a>

### Applications

Automotive and Transportation	<a href="http://www.ti.com/automotive">www.ti.com/automotive</a>
Communications and Telecom	<a href="http://www.ti.com/communications">www.ti.com/communications</a>
Computers and Peripherals	<a href="http://www.ti.com/computers">www.ti.com/computers</a>
Consumer Electronics	<a href="http://www.ti.com/consumer-apps">www.ti.com/consumer-apps</a>
Energy and Lighting	<a href="http://www.ti.com/energy">www.ti.com/energy</a>
Industrial	<a href="http://www.ti.com/industrial">www.ti.com/industrial</a>
Medical	<a href="http://www.ti.com/medical">www.ti.com/medical</a>
Security	<a href="http://www.ti.com/security">www.ti.com/security</a>
Space, Avionics and Defense	<a href="http://www.ti.com/space-avionics-defense">www.ti.com/space-avionics-defense</a>
Video and Imaging	<a href="http://www.ti.com/video">www.ti.com/video</a>

TI E2E Community Home Page

[e2e.ti.com](http://e2e.ti.com)

Mailing Address: Texas Instruments, Post Office Box 655303, Dallas, Texas 75265  
Copyright © 2012, Texas Instruments Incorporated