

LINEAR INTEGRATED CIRCUITS

DESCRIPTION

The 733 is a monolithic differential input, differential output, wideband video amplifier. It offers fixed gains of 10, 100 or 400 without external components, and adjustable gains from 10 to 400 by the use of an external resistor. No external frequency compensation components are required for any gain option. Gain stability, wide bandwidth and low phase distortion are obtained through use of the classic series-shunt feedback from the emitter follower outputs to the inputs of the second stage. The emitter follower outputs provide low output impedance, and enable the device to drive capacitive loads. The 733 is intended for use as a high performance video and pulse amplifier in communications, magnetic memories, display and video recorder systems.

FEATURES

- 120 MHz BANDWIDTH
- 250k Ω INPUT RESISTANCE
- SELECTABLE GAINS OF 10, 100 and 400
- NO FREQUENCY COMPENSATION REQUIRED

ABSOLUTE MAXIMUM RATINGS

Differential Input Voltage	$\pm 5V$
Common Mode Input Voltage	$\pm 6V$
VCC	$\pm 8V$
Output Current	10mA
Junction Temperature	$+150^{\circ}C$
Storage Temperature Range	$-65^{\circ}C$ to $+150^{\circ}C$
Operation Temperature Range	

μ A733C	$0^{\circ}C$ to $+75^{\circ}C$
μ A733	$-55^{\circ}C$ to $+75^{\circ}C$

PIN CONFIGURATIONS

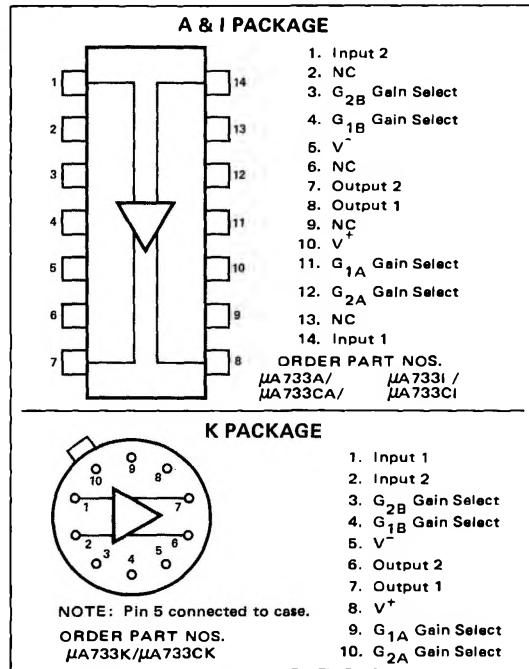

Thermal Resistance (θ_{J-A} , Junction to Ambient for each package):

A Package	0.16 $^{\circ}C/mW$
I Package	0.10 $^{\circ}C/mW$
K Package	0.145 $^{\circ}C/mW$
Power Dissipation	500mW

BASIC CIRCUIT SCHEMATIC

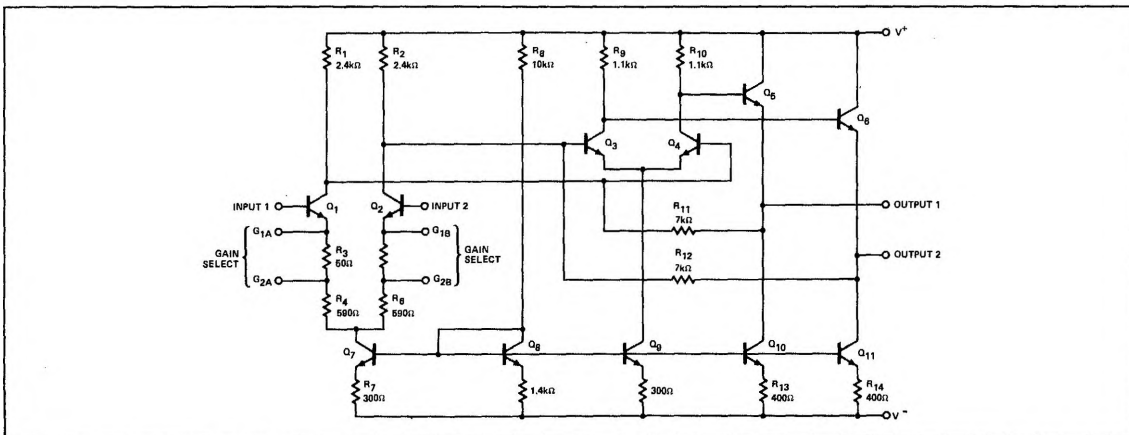

ELECTRICAL CHARACTERISTICS Standard Conditions ($T_A = +25^\circ\text{C}$, $V_S = \pm V$, $V_{CM} = 0$ unless otherwise specified)

PARAMETERS	TEST CONDITIONS		μ A733C			μ A733			UNITS
			MIN	TYP	MAX	MIN	TYP	MAX	
Differential Voltage Gain									
Gain 1		Note 1	250	400	600	300	400	500	
Gain 2	$R_i = 2\text{k}\Omega$, $V_{out} = 3V_{p-p}$	Note 2	80	100	120	90	100	110	
Gain 3		Note 3	8.0	10	12	9.0	10	11	
Bandwidth									
Gain 1		Note 1		40			40	MHz	
Gain 2		Note 2		90			90	MHz	
Gain 3		Note 3		120			120	MHz	
Rise Time									
Gain 1		Note 1		10.5			10.5	ns	
Gain 2	$V_{out} = 1V_{p-p}$	Note 2		4.5	12		4.5	10 ns	
Gain 3		Note 3		2.5			2.5	ns	
Propagation Delay									
Gain 1		Note 1		7.5			7.5	ns	
Gain 2	$V_{out} = 1V_{p-p}$	Note 2		6.0	10		6.0	10 ns	
Gain 3		Note 3		3.6			3.6	ns	
Input Resistance									
Gain 1		Note 1		4.0			4.0	$\text{k}\Omega$	
Gain 2		Note 2	10	30		20	30	$\text{k}\Omega$	
Gain 3		Note 3		250			250	$\text{k}\Omega$	
Input Capacitance	Gain 2	Note 2		2.0			2.0	pF	
Input Offset Current				0.4	5.0		0.4	3.0 μ A	
Input Bias Current				9.0	30		9.0	20 μ A	
Input Noise Voltage	BW = 1 kHz to 10 MHz			12			12	μ V _{rms}	
Input Voltage Range			± 1.0			± 1.0		V	
Common Mode Rejection Ratio									
Gain 2	$V_{CM} = \pm 1V$, $f \leq 100$ kHz		60	86		60	86	dB	
Gain 2	$V_{CM} = \pm 1V$, $F = 5$ MHz			60			60	dB	
Supply Voltage Rejection Ratio									
Gain 2	$\Delta V_S = \pm 0.5V$		50	70		50	70	dB	
Output Offset Voltage									
Gain 1	$R_L = \infty$	Note 1		0.6	1.5		0.6	1.5 V	
Gain 2 and 3		Notes 2,3		0.35	1.5		0.35	1.0 V	
Output Common Mode Voltage	$R_L = \infty$		2.4	2.9	3.4	2.4	2.9	3.4 V	
Output Voltage Swing	$R_L = 2\text{k}$		3.0	4.0		3.0	4.0		
Output Sink Current			2.5	3.6		2.5	3.6	mA	
Output Resistance				20			20	Ω	
Power Supply Current	$R_L = \infty$			18	24		18	24 mA	

Recommended Operating Supply Voltages ($V_S = \pm 6.0V$)

NOTES

- Gain select pins G_{1A} and G_{1B} connected together.
- Gain select pins G_{2A} and G_{2B} connected together.
- All gain select pins open.

TEST CIRCUITS ($T_A = 25^\circ C$ unless otherwise specified)

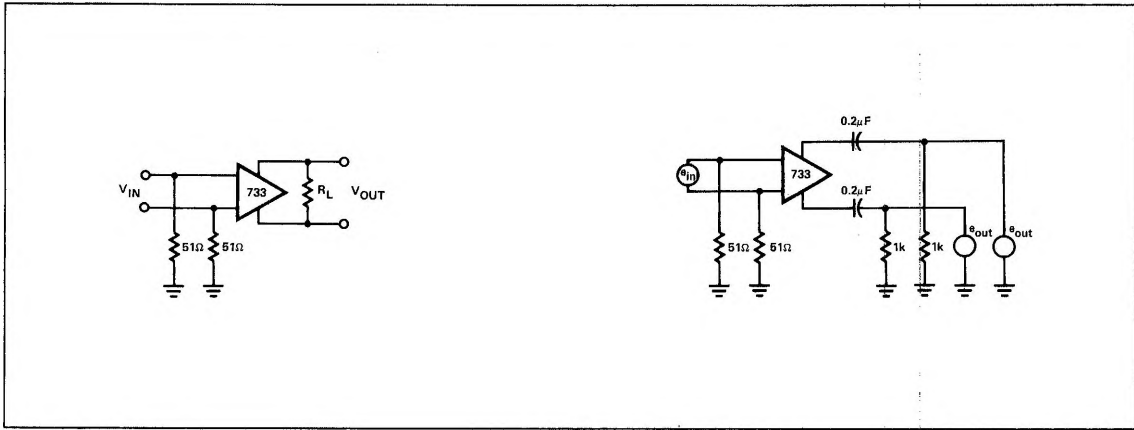

TYPICAL CHARACTERISTIC CURVES

PHASE SHIFT AS A FUNCTION OF FREQUENCY

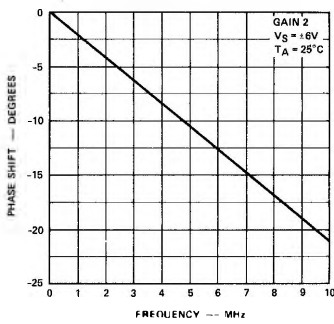

PHASE SHIFT AS A FUNCTION OF FREQUENCY

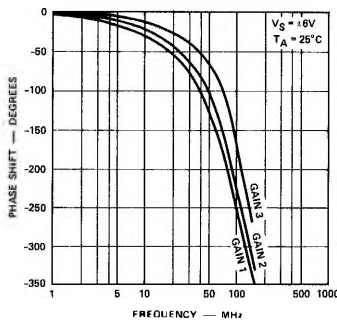

VOLTAGE GAIN AS A FUNCTION OF FREQUENCY

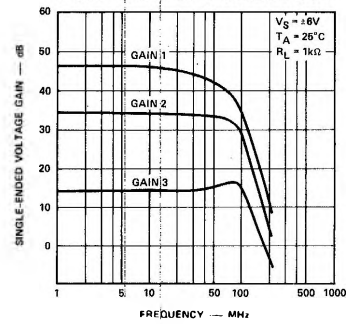

COMMON MODE REJECTION RATIO AS A FUNCTION OF FREQUENCY

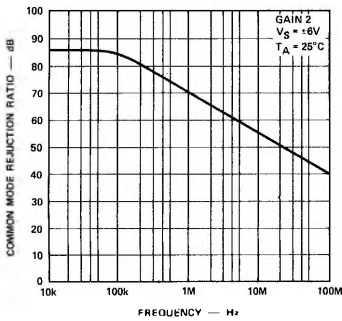

OUTPUT VOLTAGE SWING AS A FUNCTION OF FREQUENCY

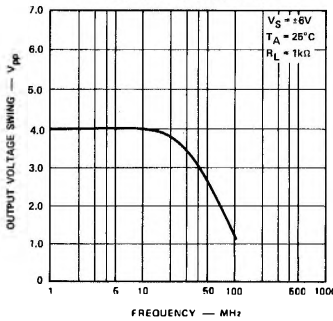

PULSE RESPONSE

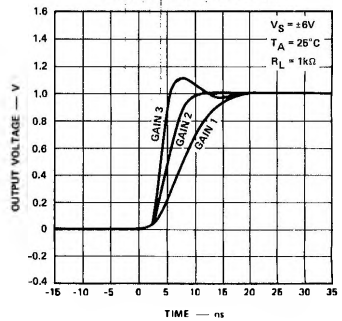

TYPICAL CHARACTERISTIC CURVES (Cont'd.)

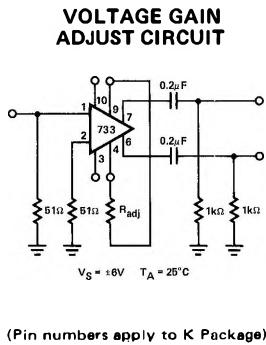
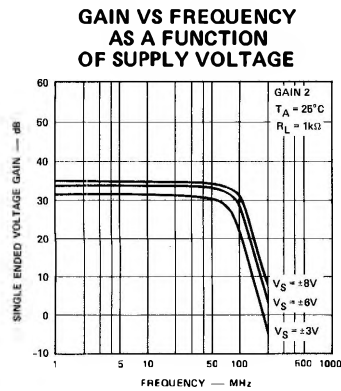
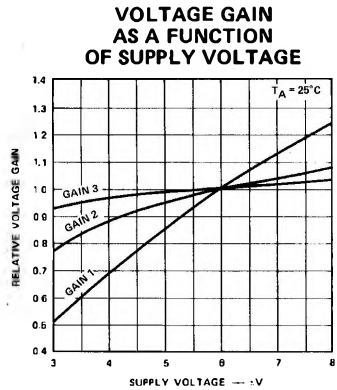
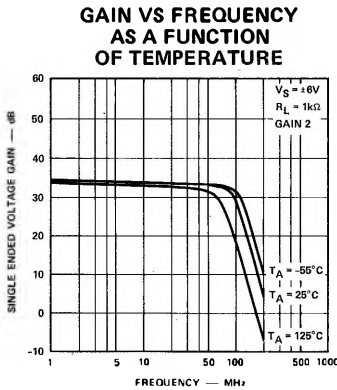
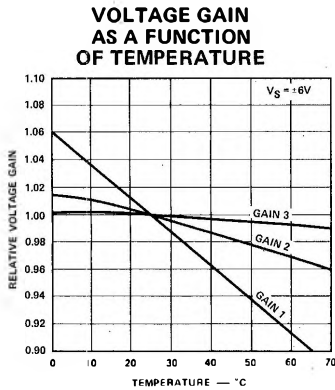
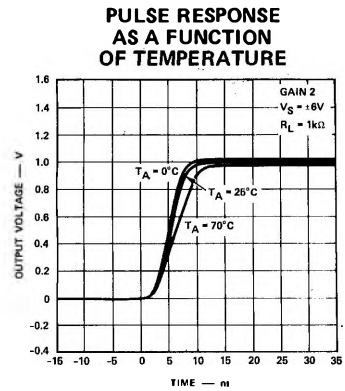
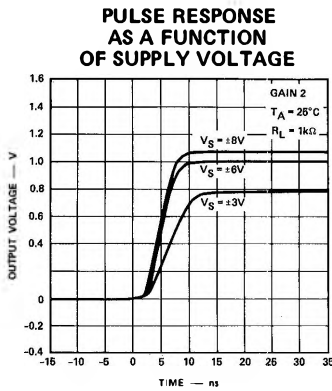
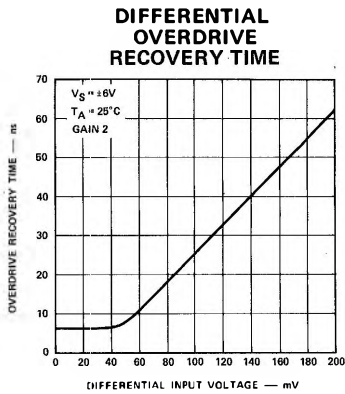
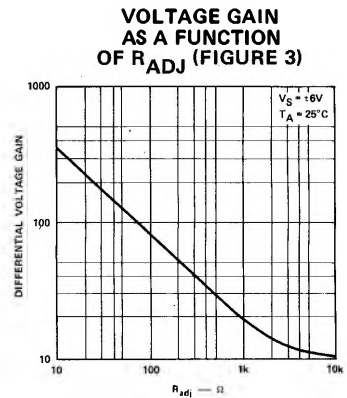
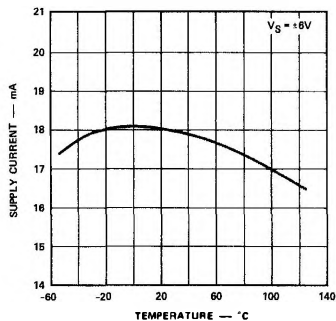

FIGURE 3



TYPICAL CHARACTERISTIC CURVES (Cont'd.)

SUPPLY CURRENT AS A FUNCTION OF TEMPERATURE



SUPPLY CURRENT AS A FUNCTION OF SUPPLY VOLTAGE

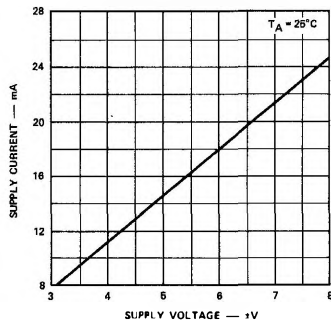

OUTPUT VOLTAGE AND CURRENT SWING AS A FUNCTION OF SUPPLY VOLTAGE

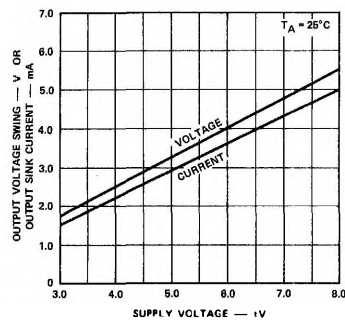

OUTPUT VOLTAGE SWING AS A FUNCTION OF LOAD RESISTANCE

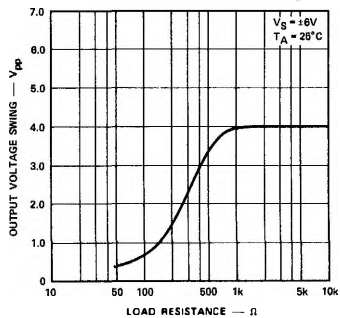

INPUT RESISTANCE AS A FUNCTION OF TEMPERATURE

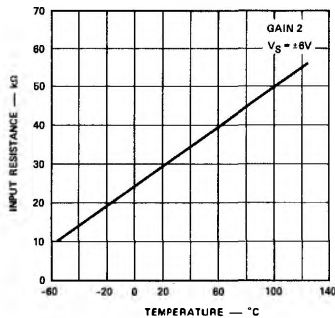

INPUT NOISE VOLTAGE AS A FUNCTION OF SOURCE RESISTANCE

