

TD62M8600F

8CH LOW SATURATION VOLTAGE SOURCE DRIVER

TD62M8600F is Multi Chip IC incorporates 8 low saturation discrete transistors equipped Fly-wheeling Diode and Bias resistor.

This IC is suitable for a battery use motor drive and LED display module applications.

Please observe the thermal condition for using.

FEATURES

- Suitable for Motor drive circuit and LED display module
- Bias Resistor and Diodes are equipped : R = 10 kΩ
- Low Saturation Voltage
 $V_{CE(sat)} = 0.13 \text{ V (Typ.) at } I_C = -1.0 \text{ A}$
 $V_{CE(sat)} = 0.25 \text{ V (Typ.) at } I_C = -2.0 \text{ A}$
- HSOP16 (1 mm pitch) power small package sealed

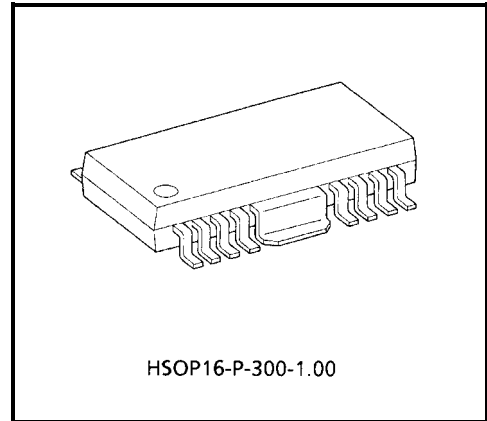

Weight: 0.50 g (Typ.)

SCHEMATICS

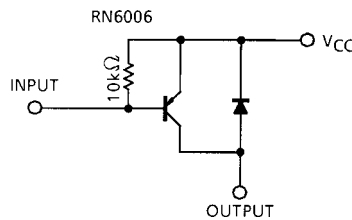

PIN CONNECTION (TOP VIEW)

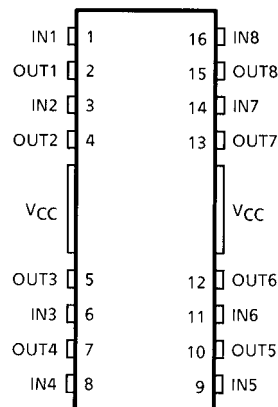

MAXIMUM RATINGS (Ta = 25°C)

CHARACTERISTIC	SYMBOL	RATING	UNIT
Supply Voltage	V _{CC}	-10	V
Breakdown Voltage	V _{CB0}	-10	V
	V _{CER}	-10	
	V _{EBO}	-6	
Output Current	I _O	-2	A / ch
	I _O (PEAK)	-4 (Note 1)	
Base Current	I _B (AVE)	-0.4	A
	I _B (PEAK)	-0.8	
Fly-wheeling Diode Forward Current	I _F	-2 (Note 2)	A
Power Dissipation	P _D	900	mW
Junction Temperature	T _j	150	°C
Operating Temperature	T _{opr}	-40~85	°C
Storage Temperature	T _{stg}	-55~150	°C

Note 1: T = 10 ms MAX. and maximum duty is less than 30%.

Note 2: T = 10 ms single pulse

ELECTRICAL CHARACTERISTICS (Ta = 25°C)

CHARACTERISTIC	SYMBOL	TEST CIR-CUIT	TEST CONDITION	MIN	TYP.	MAX	UNIT
Current Gain	h _{FE} (1)	—	V _{CE} = -1 V, I _C = -0.5 A	160	—	600	—
	h _{FE} (2)		V _{CE} = -1 V, I _C = -1.5 A	60	130	—	
Saturation Voltage	V _{CE} (sat)	—	I _C = -1 A, I _B = -25 mA	—	-0.13	-0.25	V
			I _C = 2 A, I _B = 50 mA	—	-0.25	-0.50	
Transition Frequency	f _T	—	V _{CE} = -2 V, I _C = -0.5 A	—	150	—	MHz
Leakage Current	I _{OL}	—	V _{CC} = -10 V	—	0	-10	μA
Fly-wheeling Diode Forward Voltage	V _F	—	I _F = -300 mA	—	-0.89	-1.2	V
			I _F = -450 mA, 10 ms	—	-1.60	—	
Base-Emitter Resistor	R _{BE}	—	—	7	10	13	kΩ
Base-Emitter Forward Voltage	V _{BE}	—	V _{CE} = -1 V, I _C = -2.0 A	—	-0.84	-1.5	V

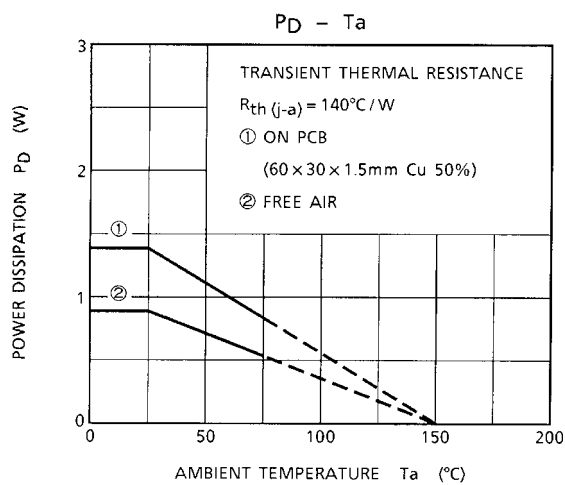
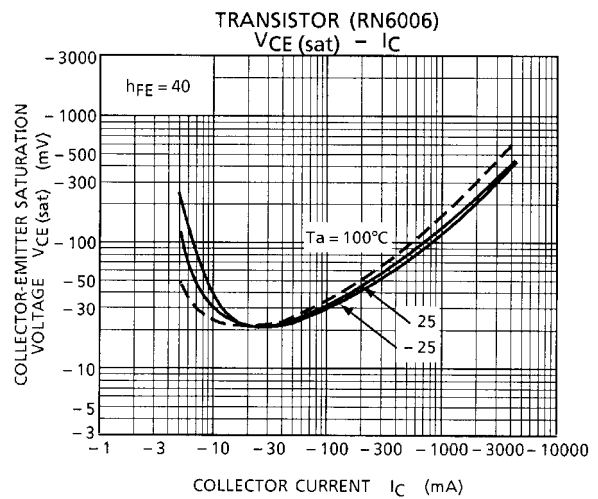
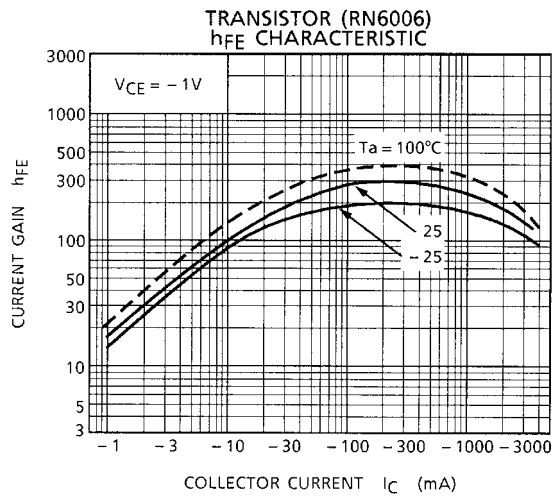

PRECAUTIONS for USING

This IC does not integrate protection circuits such as overcurrent and overvoltage protectors. Thus, if excess current or voltage is applied to the IC, the IC may be damaged. Please design the IC so that excess current or voltage will not be applied to the IC.

Utmost care is necessary in the design of the output line, VCC and GND line since IC may be destroyed due to short-circuit between outputs, air contamination fault, or fault by improper grounding.

PACKAGE DIMENSIONS

HSOP16-P-300-1.00

Unit: mm

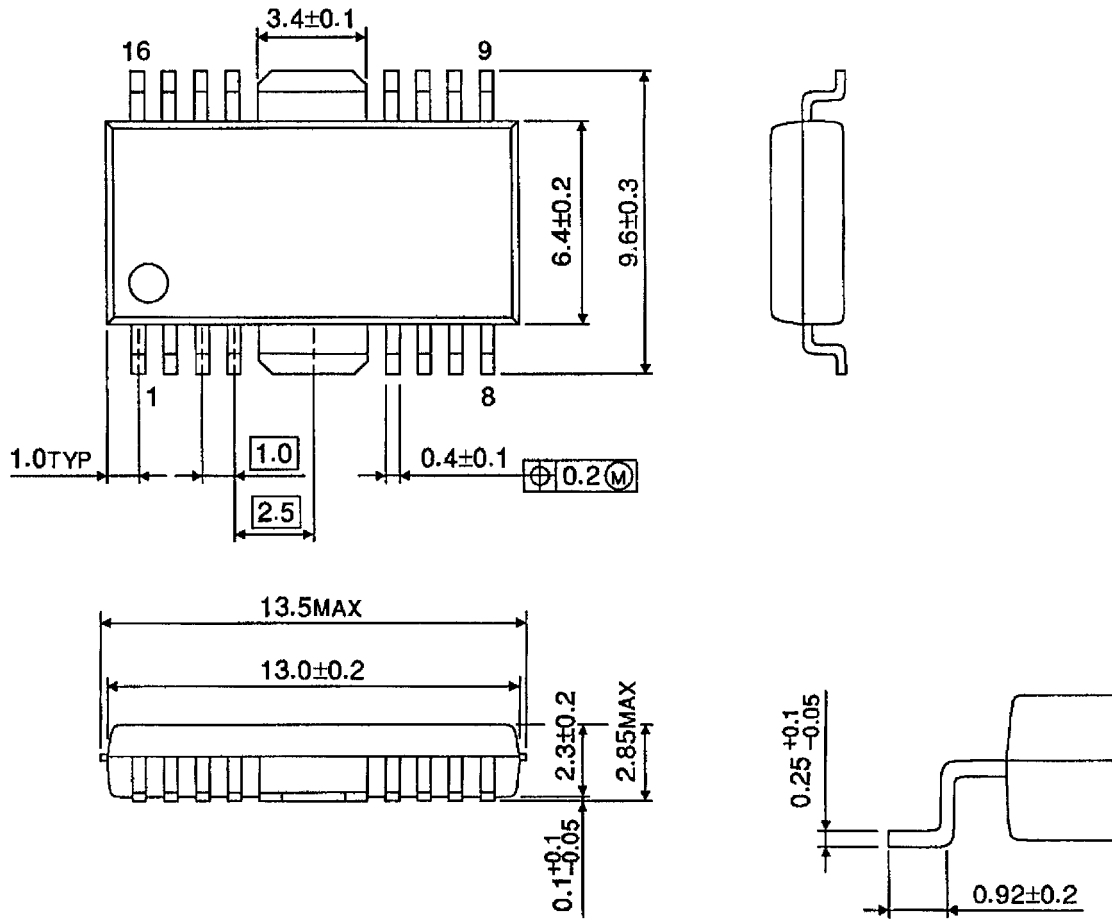

Weight: 0.50 g (Typ.)

RESTRICTIONS ON PRODUCT USE

000707EBA

- TOSHIBA is continually working to improve the quality and reliability of its products. Nevertheless, semiconductor devices in general can malfunction or fail due to their inherent electrical sensitivity and vulnerability to physical stress. It is the responsibility of the buyer, when utilizing TOSHIBA products, to comply with the standards of safety in making a safe design for the entire system, and to avoid situations in which a malfunction or failure of such TOSHIBA products could cause loss of human life, bodily injury or damage to property.
In developing your designs, please ensure that TOSHIBA products are used within specified operating ranges as set forth in the most recent TOSHIBA products specifications. Also, please keep in mind the precautions and conditions set forth in the "Handling Guide for Semiconductor Devices," or "TOSHIBA Semiconductor Reliability Handbook" etc..
- The TOSHIBA products listed in this document are intended for usage in general electronics applications (computer, personal equipment, office equipment, measuring equipment, industrial robotics, domestic appliances, etc.). These TOSHIBA products are neither intended nor warranted for usage in equipment that requires extraordinarily high quality and/or reliability or a malfunction or failure of which may cause loss of human life or bodily injury ("Unintended Usage"). Unintended Usage include atomic energy control instruments, airplane or spaceship instruments, transportation instruments, traffic signal instruments, combustion control instruments, medical instruments, all types of safety devices, etc.. Unintended Usage of TOSHIBA products listed in this document shall be made at the customer's own risk.
- The products described in this document are subject to the foreign exchange and foreign trade laws.
- The information contained herein is presented only as a guide for the applications of our products. No responsibility is assumed by TOSHIBA CORPORATION for any infringements of intellectual property or other rights of the third parties which may result from its use. No license is granted by implication or otherwise under any intellectual property or other rights of TOSHIBA CORPORATION or others.
- The information contained herein is subject to change without notice.