

TOSHIBA CMOS Digital Integrated Circuit Silicon Monolithic

TC74LCX16374FT

Low-Voltage 16-Bit D-Type Flip-Flop with 5-V Tolerant Inputs and Outputs

The TC74LCX16374FT is a high-performance CMOS 16-bit D-type flip-flop. Designed for use in 2.5-V or 3.3-V systems, it achieves high-speed operation while maintaining the CMOS low power dissipation.

The device is designed for low-voltage (2.5-V or 3.3-V) VCC applications, but it could be used to interface to 5-V supply environment for both inputs and outputs.

This 16-bit D-type flip-flop is controlled by a clock input (CK) and an output enable input (\overline{OE}) which are common to each byte. It can be used as two 8-bit flip-flops or one 16-bit flip-flop. When the \overline{OE} input is high, the outputs are in a high-impedance state.

All inputs are equipped with protection circuits against static discharge.

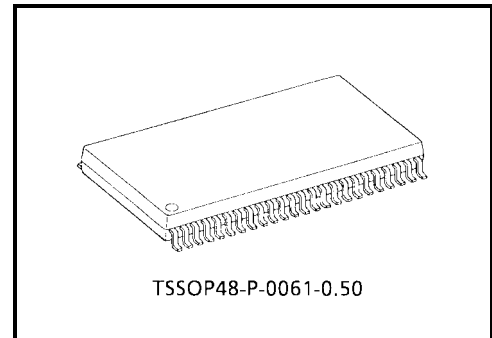

Weight: 0.25 g (typ.)

Features

- Low-voltage operation: $V_{CC} = 2.0$ to 3.6 V
- High-speed operation: $t_{pd} = 6.2$ ns (max) ($V_{CC} = 3.0$ to 3.6 V)
- Output current: $|I_{OH}|/I_{OL} = 24$ mA (min) ($V_{CC} = 3.0$ V)
- Latch-up performance: ± 500 mA
- Package: TSSOP (thin shrink small outline package)
- Power-down protection provided on all inputs and outputs

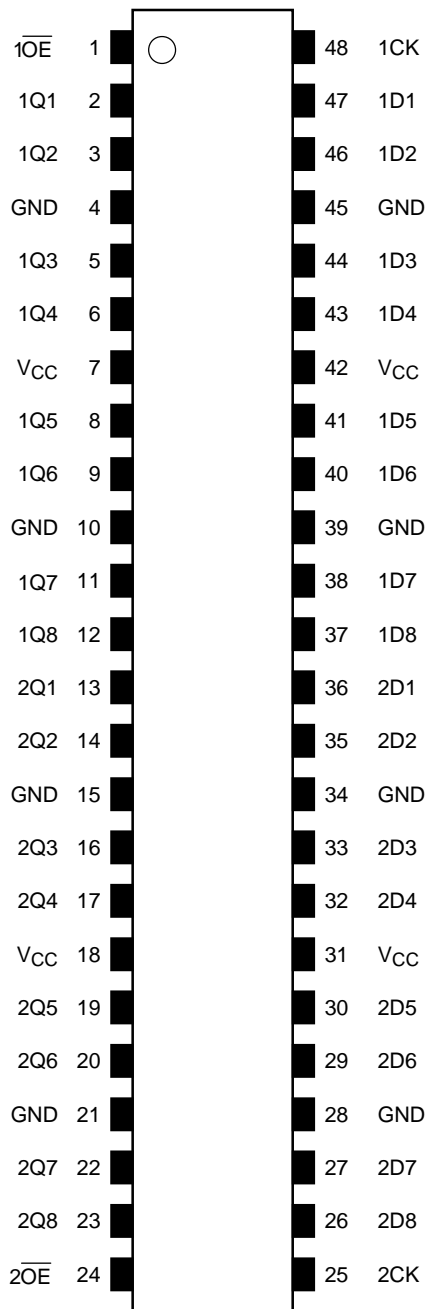

Pin Assignment (top view)



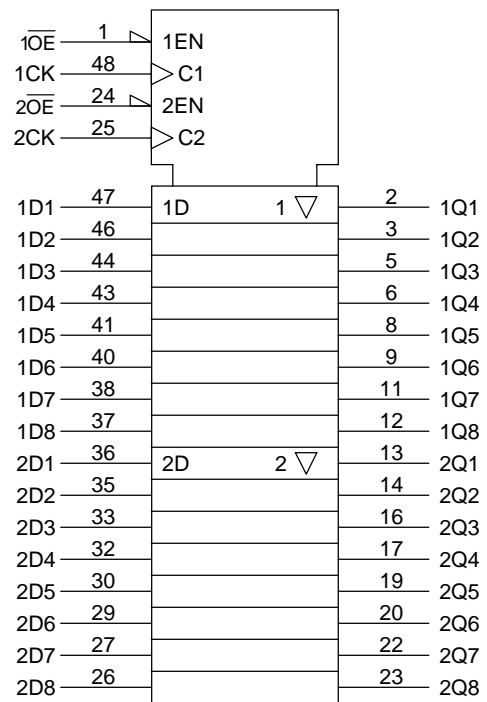

IEC Logic Symbol



Truth Table

Inputs			Outputs
$\overline{1OE}$	1CK	1D1-1D8	1Q1-1Q8
H	X	X	Z
L		X	Qn
L		L	L
L		H	H

Inputs			Outputs
$\overline{2OE}$	2CK	2D1-2D8	2Q1-2Q8
H	X	X	Z
L		X	Qn
L		L	L
L		H	H

X: Don't care

Z: High impedance

Qn: No change

System Diagram

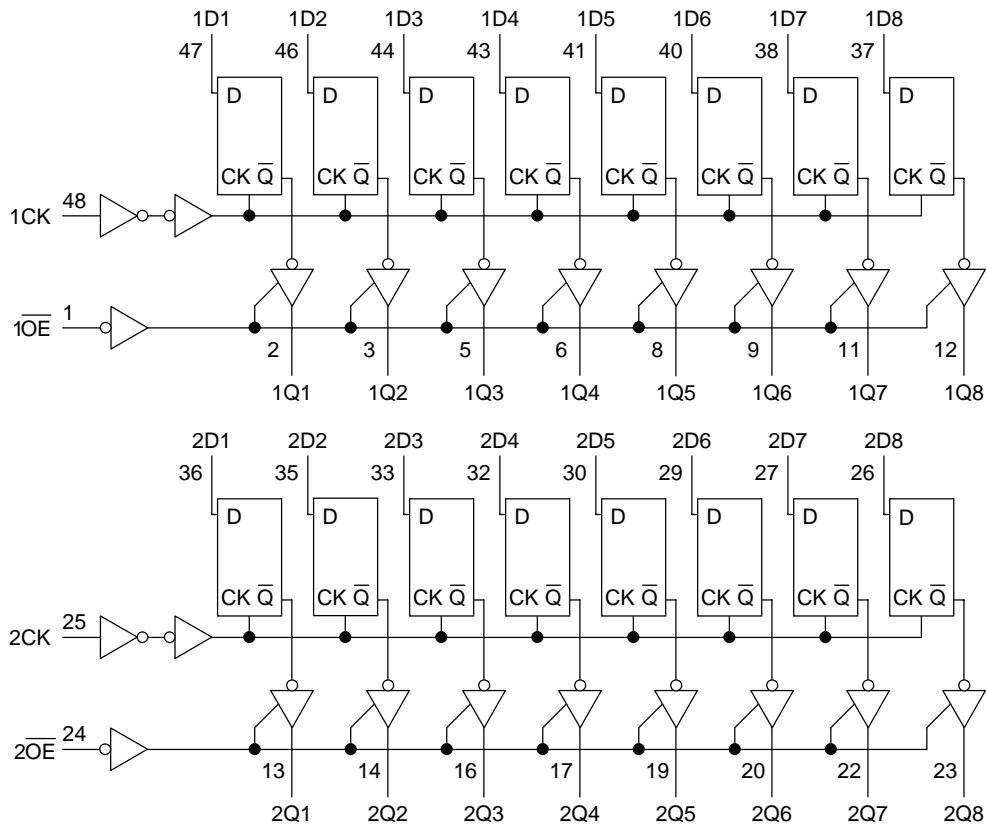

Maximum Ratings

Characteristics	Symbol	Rating	Unit
Power supply voltage	V_{CC}	-0.5 to 6.0	V
Input voltage	V_{IN}	-0.5 to 7.0	V
Output voltage	V_{OUT}	-0.5 to 7.0 (Note 1)	V
		-0.5 to $V_{CC} + 0.5$ (Note 2)	
Input diode current	I_{IK}	-50	mA
Output diode current	I_{OK}	± 50 (Note 3)	mA
DC output current	I_{OUT}	± 50	mA
Power dissipation	P_D	400	mW
DC V_{CC} /ground current per supply pin	I_{CC}/I_{GND}	± 100	mA
Storage temperature	T_{stg}	-65 to 150	$^{\circ}\text{C}$

Note 1: Output in OFF state

Note 2: High or low state. I_{OUT} absolute maximum rating must be observed.

Note 3: $V_{OUT} < \text{GND}$, $V_{OUT} > V_{CC}$

Recommended Operating Conditions

Characteristics	Symbol	Rating	Unit
Power supply voltage	V_{CC}	2.0 to 3.6	V
		1.5 to 3.6 (Note 4)	
Input voltage	V_{IN}	0 to 5.5	V
Output voltage	V_{OUT}	0 to 5.5 (Note 5)	V
		0 to V_{CC} (Note 6)	
Output current	I_{OH}/I_{OL}	± 24 (Note 7)	mA
		± 12 (Note 8)	
		± 8 (Note 9)	
Operating temperature	T_{opr}	-40 to 85	$^{\circ}\text{C}$
Input rise and fall time	dt/dv	0 to 10 (Note 10)	ns/V

Note 4: Data retention only

Note 5: Output in OFF state

Note 6: High or low state

Note 7: $V_{CC} = 3.0$ to 3.6 V

Note 8: $V_{CC} = 2.7$ to 3.0 V

Note 9: $V_{CC} = 2.3$ to 2.7 V

Note 10: $V_{IN} = 0.8$ to 2.0 V, $V_{CC} = 3.0$ V

Electrical Characteristics

DC Characteristics (Ta = -40 to 85°C)

Characteristics		Symbol	Test Condition		V _{CC} (V)	Min	Max	Unit	
Input voltage	H-level	V _{IH}	—		2.3 to 2.7	1.7	—	V	
					2.7 to 3.6	2.0	—		
	L-level	V _{IL}			2.3 to 2.7	—	0.7		
					2.7 to 3.6	—	0.8		
Output voltage	H-level	V _{OH}	V _{IN} = V _{IH} or V _{IL}		I _{OH} = -100 μA	2.3 to 3.6	V _{CC} - 0.2	—	V
					I _{OH} = -8 mA	2.3	1.8	—	
					I _{OH} = -12 mA	2.7	2.2	—	
					I _{OH} = -18 mA	3.0	2.4	—	
					I _{OH} = -24 mA	3.0	2.2	—	
	L-level	V _{OL}			I _{OL} = 100 μA	2.3 to 3.6	—	0.2	
					I _{OL} = 8 mA	2.3	—	0.6	
					I _{OL} = 12 mA	2.7	—	0.4	
					I _{OL} = 16 mA	3.0	—	0.4	
					I _{OL} = 24 mA	3.0	—	0.55	
Input leakage current		I _{IN}	V _{IN} = 0 to 5.5 V		2.3 to 3.6	—	±5.0	μA	
3-state output OFF state current		I _{OZ}	V _{IN} = V _{IH} or V _{IL} V _{OUT} = 0 to 5.5 V		2.3 to 3.6	—	±5.0	μA	
Power-off leakage current		I _{OFF}	V _{IN} /V _{OUT} = 5.5 V		0	—	10.0	μA	
Quiescent supply current		I _{CC}	V _{IN} = V _{CC} or GND		2.3 to 3.6	—	20.0	μA	
			V _{IN} /V _{OUT} = 3.6 to 5.5 V		2.3 to 3.6	—	±20.0		
Increase in I _{CC} per input		ΔI _{CC}	V _{IH} = V _{CC} - 0.6 V		2.3 to 3.6	—	500		

AC Characteristics (Ta = -40 to 85°C)

Characteristics	Symbol	Test Condition	Test Condition		Min	Max	Unit
			V _{CC} (V)	CL(pF)			
Maximum clock frequency	f _{max}	Figure 1, Figure 2	2.5 ± 0.2	30	—	—	MHz
			2.7	50	—	—	
			3.3 ± 0.3	50	170	—	
Propagation delay time (CK-Q)	t _{pLH} t _{pHL}	Figure 1, Figure 2	2.5 ± 0.2	30	1.5	7.4	ns
			2.7	50	1.5	6.5	
			3.3 ± 0.3	50	1.5	6.2	
3-state output enable time	t _{pZL} t _{pZH}	Figure 1, Figure 3	2.5 ± 0.2	30	1.5	7.9	ns
			2.7	50	1.5	6.3	
			3.3 ± 0.3	50	1.5	6.1	
3-state output disable time	t _{pLZ} t _{pHZ}	Figure 1, Figure 3	2.5 ± 0.2	30	1.5	7.2	ns
			2.7	50	1.5	6.2	
			3.3 ± 0.3	50	1.5	6.0	
Minimum pulse width (CK)	t _w (H) t _w (L)	Figure 1, Figure 2	2.5 ± 0.2	30	3.5	—	ns
			2.7	50	3.0	—	
			3.3 ± 0.3	50	3.0	—	
Minimum setup time	t _s	Figure 1, Figure 2	2.5 ± 0.2	30	3.0	—	ns
			2.7	50	2.5	—	
			3.3 ± 0.3	50	2.5	—	
Minimum hold time	t _h	Figure 1, Figure 2	2.5 ± 0.2	30	2.0	—	ns
			2.7	50	1.5	—	
			3.3 ± 0.3	50	1.5	—	
Output to output skew	t _{osLH} t _{osHL}	(Note 11)	2.5 ± 0.2	30	—	—	ns
			2.7	50	—	—	
			3.3 ± 0.3	50	—	1.0	

Note 11: Parameter guaranteed by design.
 (t_{osLH} = |t_{pLHm} - t_{pLHn}|, t_{osHL} = |t_{pHLm} - t_{pHLn}|)

Dynamic Switching Characteristics
 (Ta = 25°C, input: t_r = t_f = 2.5 ns, R_L = 500 Ω)

Characteristics	Symbol	Test Condition	Test Condition		Typ.	Unit
			V _{CC} (V)			
Quiet output maximum dynamic V _{OL}	V _{OLP}	V _{IH} = 2.5 V, V _{IL} = 0 V, C _L = 30pF	2.5	0.6	V	
			3.3	0.8		
Quiet output minimum dynamic V _{OL}	V _{OLV}	V _{IH} = 2.5 V, V _{IL} = 0 V, C _L = 30pF	2.5	0.6	V	
			3.3	0.8		

Capacitive Characteristics (Ta = 25°C)

Characteristics	Symbol	Test Condition	V _{CC} (V)	Typ.	Unit
Input capacitance	C _{IN}	—	3.3	7	pF
Output capacitance	C _{OUT}	—	3.3	8	pF
Power dissipation capacitance	C _{PD}	f _{IN} = 10 MHz (Note 12)	3.3	25	pF

Note 12: C_{PD} is defined as the value of the internal equivalent capacitance which is calculated from the operating current consumption without load.

Average operating current can be obtained by the equation:

$$I_{CC (opr)} = C_{PD} \cdot V_{CC} \cdot f_{IN} + I_{CC}/16 \text{ (per bit)}$$

AC Test Circuit

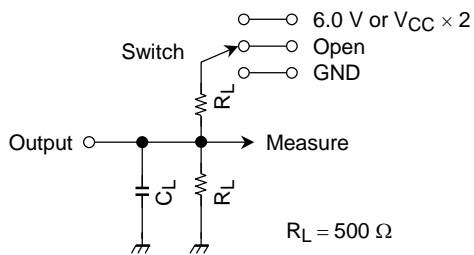

Parameter	Switch
t _{pLH} , t _{pHL}	Open
t _{pLZ} , t _{pZL}	6.0 V @V _{CC} = 3.3 ± 0.3 V V _{CC} × 2 @V _{CC} = 2.5 ± 0.2 V
t _{pHZ} , t _{pZH}	GND

Figure 1

Package Dimensions

TSSOP48-P-0061-0.50

Unit : mm

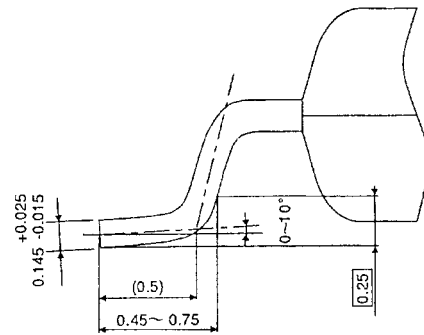
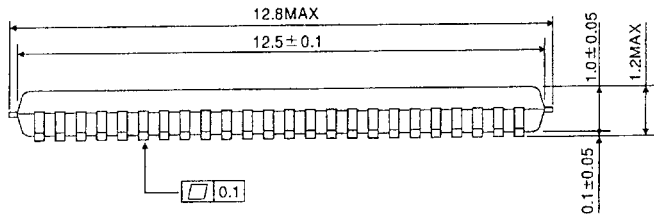
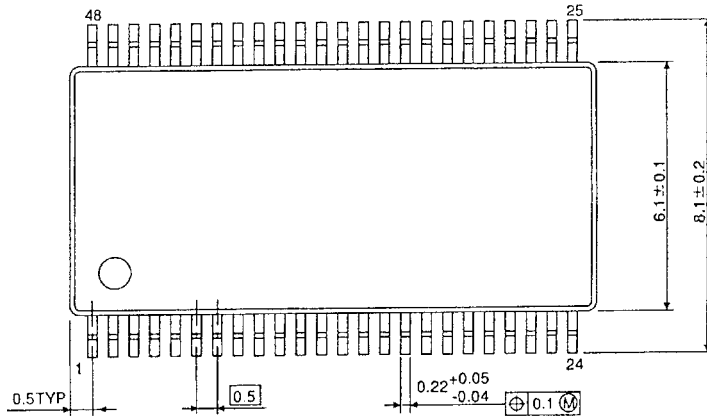

Weight: 0.25 g (typ.)

RESTRICTIONS ON PRODUCT USE

000707EBA

- TOSHIBA is continually working to improve the quality and reliability of its products. Nevertheless, semiconductor devices in general can malfunction or fail due to their inherent electrical sensitivity and vulnerability to physical stress. It is the responsibility of the buyer, when utilizing TOSHIBA products, to comply with the standards of safety in making a safe design for the entire system, and to avoid situations in which a malfunction or failure of such TOSHIBA products could cause loss of human life, bodily injury or damage to property.
In developing your designs, please ensure that TOSHIBA products are used within specified operating ranges as set forth in the most recent TOSHIBA products specifications. Also, please keep in mind the precautions and conditions set forth in the "Handling Guide for Semiconductor Devices," or "TOSHIBA Semiconductor Reliability Handbook" etc..
- The TOSHIBA products listed in this document are intended for usage in general electronics applications (computer, personal equipment, office equipment, measuring equipment, industrial robotics, domestic appliances, etc.). These TOSHIBA products are neither intended nor warranted for usage in equipment that requires extraordinarily high quality and/or reliability or a malfunction or failure of which may cause loss of human life or bodily injury ("Unintended Usage"). Unintended Usage include atomic energy control instruments, airplane or spaceship instruments, transportation instruments, traffic signal instruments, combustion control instruments, medical instruments, all types of safety devices, etc.. Unintended Usage of TOSHIBA products listed in this document shall be made at the customer's own risk.
- The products described in this document are subject to the foreign exchange and foreign trade laws.
- The information contained herein is presented only as a guide for the applications of our products. No responsibility is assumed by TOSHIBA CORPORATION for any infringements of intellectual property or other rights of the third parties which may result from its use. No license is granted by implication or otherwise under any intellectual property or other rights of TOSHIBA CORPORATION or others.
- The information contained herein is subject to change without notice.