

TC4S584F

SCHMITT TRIGGER

TC4S584F is the one circuit inverter having the schmitt trigger function at the input terminal.

That is, since the circuit threshold level voltage at the leading and trailing edges of input waveform are different (V_P , V_N), the TC4S584F can be used in the broad range application, including line receiver, waveform shaping circuit, astable multivibrator, etc. In addition to ordinary inverter.

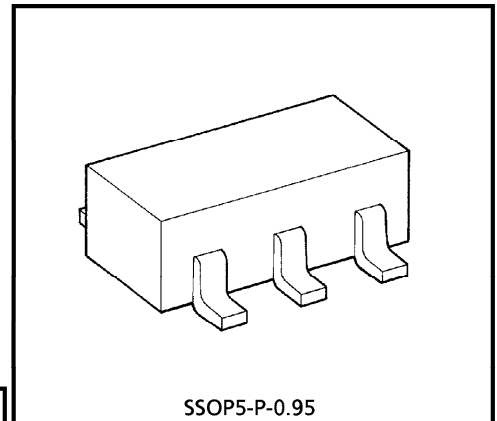

SSOP5-P-0.95

Weight : 0.016g (Typ.)

MAXIMUM RATINGS

CHARACTERISTIC	SYMBOL	RATING	UNIT
DC Supply Voltage	V_{DD}	$V_{SS} - 0.5 \sim V_{SS} + 20$	V
Input Voltage	V_{IN}	$V_{SS} - 0.5 \sim V_{DD} + 0.5$	V
Output Voltage	V_{OUT}	$V_{SS} - 0.5 \sim V_{DD} + 0.5$	V
DC Input Current	I_{IN}	± 10	mA
Power Dissipation	P_D	200	mW
Operating Temperature Range	T_{opr}	$-40 \sim 85$	$^{\circ}C$
Storage Temperature Range	T_{stg}	$-65 \sim 150$	$^{\circ}C$
Lead Temperature (10s)	T_L	260	$^{\circ}C$

LOGIC DIAGRAM

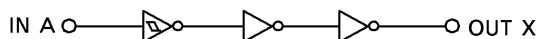

PIN ASSIGNMENT (TOP VIEW)

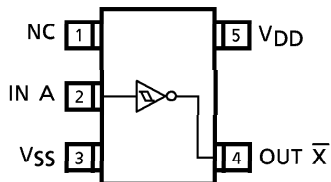

MARKING

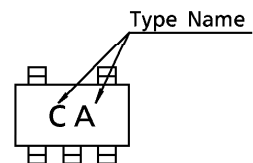

RECOMMENDED OPERATING CONDITIONS (V_{SS} = 0V)

CHARACTERISTIC	SYMBOL	MIN.	TYP.	MAX.	UNIT	
DC Supply Voltage	V _{DD}	—	3	—	18	V
Input Voltage	V _{IN}	—	0	—	V _{DD}	V

STATIC ELECTRICAL CHARACTERISTICS (V_{SS} = 0V)

CHARACTERISTIC	SYM-BOL	TEST CONDITION	V _{DD} (V)	- 40°C		25°C			85°C		UNIT	
				MIN.	MAX.	MIN.	TYP.	MAX.	MIN.	MAX.		
High-Level Output Voltage	V _{OH}	I _{OUT} < 1μA V _{IN} = V _{SS} , V _{DD}	5	4.95	—	4.95	5.00	—	4.95	—	V	
			10	9.95	—	9.95	10.00	—	9.95	—		
			15	14.95	—	14.95	15.00	—	14.95	—		
Low-Level Output Voltage	V _{OL}	I _{OUT} < 1μA V _{IN} = V _{SS} , V _{DD}	5	—	0.05	—	0.00	0.05	—	0.05	V	
			10	—	0.05	—	0.00	0.05	—	0.05		
			15	—	0.05	—	0.00	0.05	—	0.05		
Output High Current	I _{OH}	V _{OH} = 4.6V V _{OH} = 2.5V V _{OH} = 9.5V V _{OH} = 13.5V V _{IN} = V _{SS} , V _{DD}	5	-0.61	—	-0.51	-1.0	—	-0.42	—	mA	
			5	-2.5	—	-2.1	-4.0	—	-1.7	—		
			10	-1.5	—	-1.3	-2.2	—	-1.1	—		
			15	-4.0	—	-3.4	-9.0	—	-2.8	—		
Output Low Current	I _{OL}	V _{OL} = 0.4V V _{OL} = 0.5V V _{OL} = 1.5V V _{IN} = V _{SS} , V _{DD}	5	0.61	—	0.51	1.5	—	0.42	—	mA	
			10	1.5	—	1.3	3.8	—	1.1	—		
			15	4.0	—	3.4	15.0	—	2.8	—		
			—	—	—	—	—	—	—	—		—
Positive Trigger Threshold Voltage*	V _P	V _{OUT} = 0.5V V _{OUT} = 1.0V V _{OUT} = 1.5V	5	1.95	3.65	2.05	2.9	3.35	2.05	3.75	V	
			10	4.3	7.1	4.5	5.9	7.1	4.7	7.2		
			15	6.9	10.7	7.1	9.0	10.6	7.1	10.8		
Negative Trigger Threshold Voltage*	V _N	V _{OUT} = 4.5V V _{OUT} = 9.0V V _{OUT} = 13.5V	5	1.05	2.75	1.1	2.1	2.6	0.95	2.65	V	
			10	2.1	4.9	2.2	3.5	4.7	2.0	4.8		
			15	3.2	7.0	3.3	5.0	6.8	3.1	6.9		
Hysteresis Voltage*	V _H	—	5	0.1	1.35	0.4	0.75	1.3	0.4	1.50	V	
			10	1.7	3.2	1.8	2.4	3.2	1.7	3.4		
			15	3.1	4.8	3.2	4.0	4.8	3.2	4.9		
Input Current	H Level	I _{IH}	V _{IH} = 18V	18	—	0.1	—	10 ⁻⁵	0.1	—	1.0	μA
	L Level	I _{IL}	V _{IL} = 0V	18	—	-0.1	—	-10 ⁻⁵	-0.1	—	-1.0	
Quiescent Device Current	I _{DD}	V _{IN} = V _{SS} , V _{DD}	5	—	1	—	0.001	1	—	7.5	μA	
			10	—	2	—	0.002	2	—	15		
			15	—	4	—	0.004	4	—	30		

(Note) Values are different to TC4584BP, TC4584BF marked* (V_P, V_N, V_H).

DYNAMIC ELECTRICAL CHARACTERISTICS (Ta = 25°C, VSS = 0V, CL = 50pF)

CHARACTERISTIC	SYMBOL	TEST CONDITION	VDD (V)	MIN.	TYP.	MAX.	UNIT
Output Transition Time (Low to High)	tTLH	—	5	—	80	200	ns
			10	—	50	100	
			15	—	40	80	
Output Transition Time (High to Low)	tTHL	—	5	—	80	200	ns
			10	—	50	100	
			15	—	40	80	
Propagation Delay Time	t _p LH	—	5	—	170	340	ns
	t _p HL		10	—	80	160	
			15	—	60	120	
Input Capacitance	C _{IN}	—		—	5	7.5	pF

CIRCUIT AND WAVEFORM FOR MEASUREMENT OF DYNAMIC CHARACTERISTICS

CIRCUIT

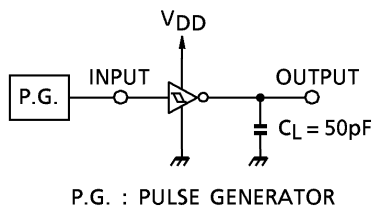

WAVEFORM

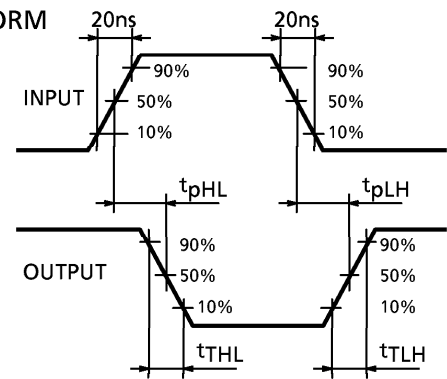

INPUT-OUTPUT VOLTAGE CHARACTERISTICS

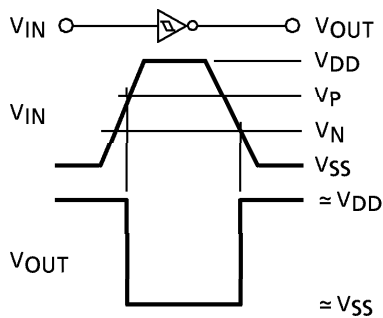

● INPUT-OUTPUT VOLTAGE WAVEFORM

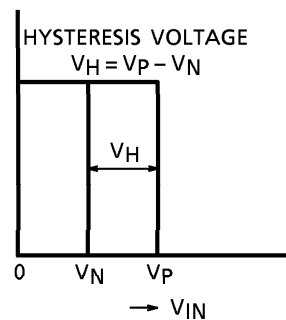

● TRANSFER CHARACTERISTICS

PACKAGE DIMENSIONS
SSOP5-P-0.95

Unit : mm



Weight : 0.016g (Typ.)

RESTRICTIONS ON PRODUCT USE

000707EBA

- TOSHIBA is continually working to improve the quality and reliability of its products. Nevertheless, semiconductor devices in general can malfunction or fail due to their inherent electrical sensitivity and vulnerability to physical stress. It is the responsibility of the buyer, when utilizing TOSHIBA products, to comply with the standards of safety in making a safe design for the entire system, and to avoid situations in which a malfunction or failure of such TOSHIBA products could cause loss of human life, bodily injury or damage to property. In developing your designs, please ensure that TOSHIBA products are used within specified operating ranges as set forth in the most recent TOSHIBA products specifications. Also, please keep in mind the precautions and conditions set forth in the "Handling Guide for Semiconductor Devices," or "TOSHIBA Semiconductor Reliability Handbook" etc..
- The TOSHIBA products listed in this document are intended for usage in general electronics applications (computer, personal equipment, office equipment, measuring equipment, industrial robotics, domestic appliances, etc.). These TOSHIBA products are neither intended nor warranted for usage in equipment that requires extraordinarily high quality and/or reliability or a malfunction or failure of which may cause loss of human life or bodily injury ("Unintended Usage"). Unintended Usage include atomic energy control instruments, airplane or spaceship instruments, transportation instruments, traffic signal instruments, combustion control instruments, medical instruments, all types of safety devices, etc.. Unintended Usage of TOSHIBA products listed in this document shall be made at the customer's own risk.
- The products described in this document are subject to the foreign exchange and foreign trade laws.
- The information contained herein is presented only as a guide for the applications of our products. No responsibility is assumed by TOSHIBA CORPORATION for any infringements of intellectual property or other rights of the third parties which may result from its use. No license is granted by implication or otherwise under any intellectual property or other rights of TOSHIBA CORPORATION or others.
- The information contained herein is subject to change without notice.