

DATA SHEET

SA7026

1.3GHz low voltage fractional-N
dual frequency synthesizer

Product specification
Supersedes data of 1998 Oct 16

1999 Apr 16

1.3GHz low voltage fractional-N dual synthesizer

SA7026

GENERAL DESCRIPTION

The SA7026 BICMOS device integrates programmable dividers, charge pumps and a phase comparator to implement a phase-locked loop. The device is designed to operate from 3 NiCd cells, in pocket phones, with low current and nominal 3 V supplies.

The synthesizer operates at VCO input frequencies up to 1.3 GHz. The synthesizer has fully programmable main, auxiliary and reference dividers. All divider ratios are supplied via a 3-wire serial programming bus.

Separate power and ground pins are provided to the analog and digital circuits. The ground leads should be externally short-circuited to prevent large currents flowing across the die and thus causing damage. V_{DDCP} must be greater than or equal to V_{DD} .

The charge pump current (gain) is set by an external resistance at R_{SET} pin. Passive loop filters could be used; the charge pump operates within a wide voltage compliance range to provide a wider tuning range.

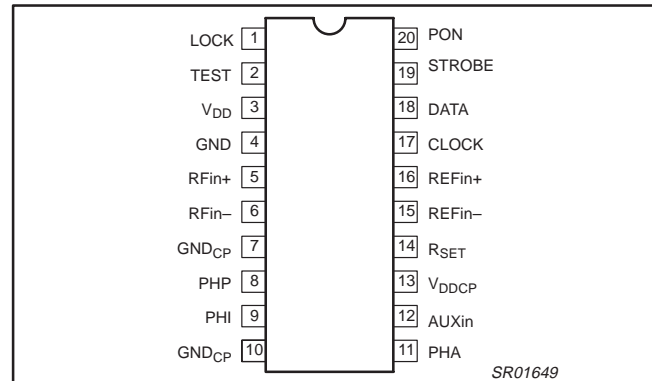

Figure 1. Pin Configuration

FEATURES

- Low phase noise
- Low power
- Fully programmable main and auxiliary dividers
- Normal & Integral charge pumps outputs
- Fast Locking Adaptive mode design
- Internal fractional spurious compensation
- Hardware and software power down
- Split supply for V_{DD} and V_{DDCP}

APPLICATIONS

- 350 to 1300 MHz wireless equipment
- Cellular phones (all standards)
- WLAN
- Portable battery-powered radio equipment.

QUICK REFERENCE DATA

SYMBOL	PARAMETER	CONDITIONS	MIN.	TYP.	MAX.	UNIT
V_{DD}	Supply voltage		2.7	–	5.5	V
V_{DDCP}	Analog supply voltage	$V_{DDCP} \geq V_{DD}$	2.7	–	5.5	V
$I_{DDCP}+I_{DD}$	Supply current	Main and Aux. on	–	7.5	8.8	mA
$I_{DDCP}+I_{DD}$	Total supply current in power-down mode		–	1	–	μ A
f_{VCO}	Input frequency		350	–	1300	MHz
f_{AUX}	Input frequency		10	–	550	MHz
f_{REF}	Crystal reference input frequency		5	–	40	MHz
f_{PC}	Maximum phase comparator frequency		–		4	MHz
T_A	Operating ambient temperature		–40	–	+85	$^{\circ}$ C

ORDERING INFORMATION

TYPE NUMBER	PACKAGE		
	NAME	DESCRIPTION	VERSION
SA7026DH	TSSOP20	Plastic thin shrink small outline package; 20 leads; body width 4.4 mm	SOT360–1

1.3GHz low voltage fractional-N dual synthesizer

SA7026

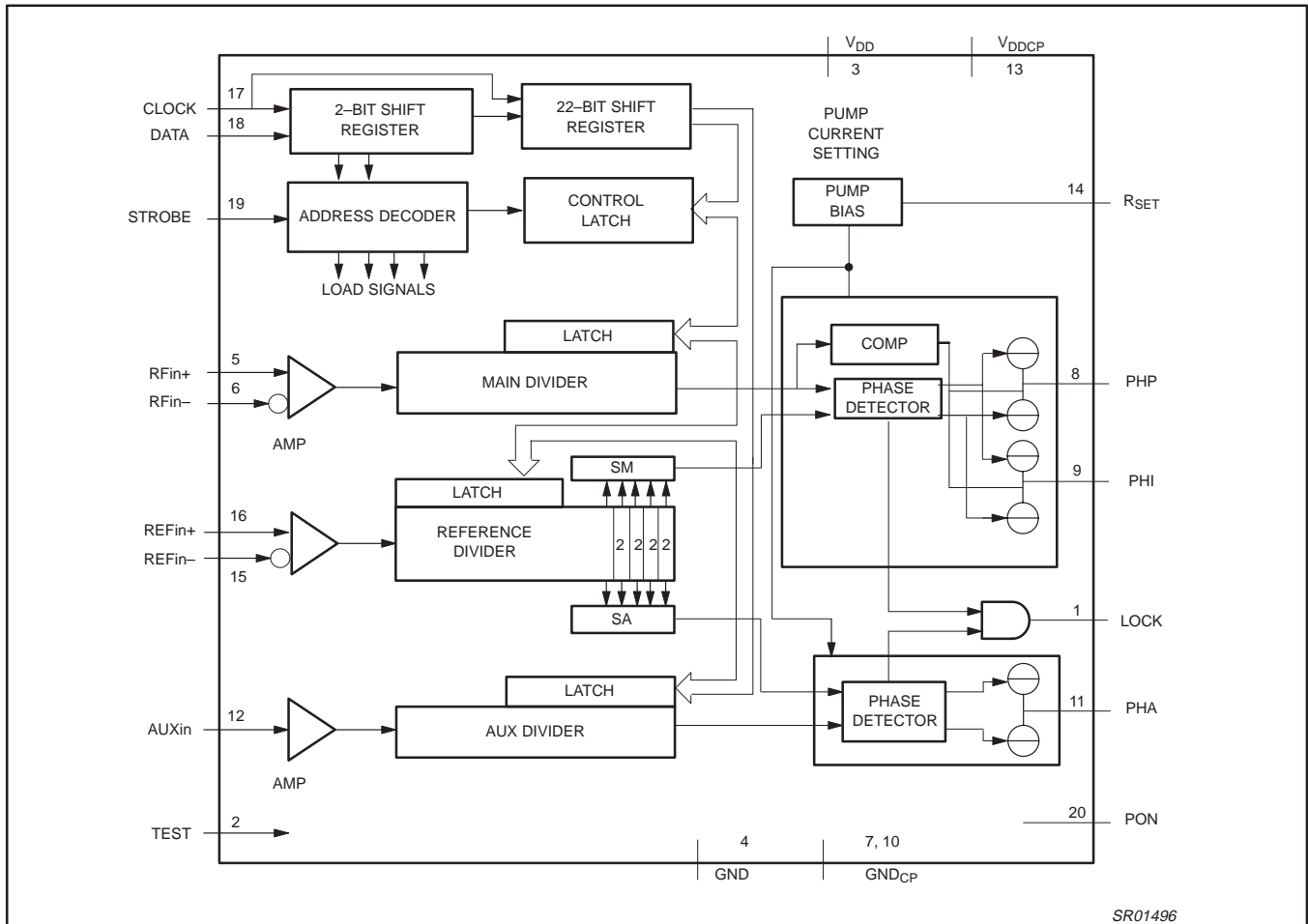

Figure 2. Block Diagram

PINNING

SYMBOL	PIN	DESCRIPTION
LOCK	1	Lock detect output
TEST	2	Test (should be either grounded or connected to V _{DD})
V _{DD}	3	Digital supply
GND	4	Digital ground
RFIn+	5	RF input to main divider
RFIn-	6	RF input to main divider
GND _{CP}	7	Charge pump ground
PHP	8	Main normal charge pump
PHI	9	Main integral charge pump
GND _{CP}	10	Charge pump ground

SYMBOL	PIN	DESCRIPTION
PHA	11	Auxiliary charge pump output
AUXin	12	Input to auxiliary divider
V _D DCP	13	Charge pump supply voltage
R _{SET}	14	External resistor from this pin to ground sets the charge pump current
REFIn-	15	Reference input
REFIn+	16	Reference input
CLOCK	17	Programming bus clock input
DATA	18	Programming bus data input
STROBE	19	Programming bus enable input
PON	20	Power down control

1.3GHz low voltage fractional-N dual synthesizer

SA7026

Limiting values

SYMBOL	PARAMETER	MIN.	MAX.	UNIT
V_{DD}	Digital supply voltage	-0.3	+5.5	V
V_{DDCP}	Analog supply voltage	-0.3	+5.5	V
$\Delta V_{DDCP}-V_{DD}$	Difference in voltage between V_{DDCP} and V_{DD} ($V_{DDCP} \geq V_{DD}$)	-0.3	+2.8	V
V_n	Voltage at pins 1, 2, 5, 6, 12, 15 to 20	-0.3	$V_{DD} + 0.3$	V
V_n	Voltage at pin 8, 9, 11	-0.3	$V_{DDCP} + 0.3$	V
ΔV_{GND}	Difference in voltage between GND_{CP} and GND (these pins should be connected together)	-0.3	+0.3	V
T_{stg}	Storage temperature	-55	+125	°C
T_{amb}	Operating ambient temperature	-40	+85	°C
T_j	Maximum junction temperature		150	°C

Handling

Inputs and outputs are protected against electrostatic discharge in normal handling. However, to be totally safe, it is desirable to take normal precautions appropriate to handling MOS devices.

Thermal characteristics

SYMBOL	PARAMETER	VALUE	UNIT
R_{thj-a}	Thermal resistance from junction to ambient in free air	135	K/W

1.3GHz low voltage fractional-N dual synthesizer

SA7026

CHARACTERISTICS $V_{DDCP} = V_{DD} = +3.0V$, $T_A = +25^\circ C$; unless otherwise specified.

SYMBOL	PARAMETER	CONDITIONS	MIN.	TYP.	MAX.	UNIT
Supply; pins 3, 13						
V_{DD}	Digital supply voltage		2.7	–	5.5	V
V_{DDCP}	Analog supply voltage	$V_{DDCP} \geq V_{DD}$	2.7	–	5.5	V
$I_{DDTotal}$	Synthesizer operational digital supply current	$V_{DD} = +3.0V$ (with main and aux on)	–	7.5	8.8	mA
$I_{Standby}$	Total supply current in power-down mode	logic levels 0 or V_{DD}	–	1	–	μA
RFin main divider input; pins 5, 6						
f_{VCO}	VCO input frequency		350	–	1300	MHz
$V_{RFin(rms)}$	AC-coupled input signal level	R_{in} (external) = $R_S = 50\Omega$; single-ended drive; max. limit is indicative @ 500 to 1300 MHz	–18	–	0	dBm
Z_{IRFin}	Input impedance (real part)	$f_{VCO} = 1.2$ GHz	–	300	–	Ω
C_{IRFin}	Typical pin input capacitance	$f_{VCO} = 1.2$ GHz	–	1	–	pF
N_{main}	Main divider ratio		512	–	65535	
f_{PCmax}	Maximum loop comparison frequency	indicative, not tested	–	–	4	MHz
AUX reference divider input; pin 12						
f_{AUXin}	Input frequency range		20	–	550	MHz
V_{AUXin}	AC-coupled input signal level	R_{in} (external) = $R_S = 50\Omega$; max. limit is indicative	–18	–	0	dBm
			80	–	636	mV _{PP}
Z_{AUXin}	Input impedance (real part)	$f_{VCO} = 500$ MHz	–	3.9	–	k Ω
C_{AUXin}	Typical pin input capacitance	$f_{VCO} = 500$ MHz	–	1	–	pF
N_{AUX}	Auxiliary division ratio		128	–	16383	
Reference divider input; pins 15, 16						
f_{REFin}	Input frequency range from TCXO		5	–	40	MHz
V_{REFin}	AC-coupled input signal level	single-ended drive; max. limit is indicative	360	–	1300	mV _{PP}
Z_{REFin}	Input impedance (real part)	$f_{REF} = 20$ MHz	–	10	–	k Ω
C_{REFin}	Typical pin input capacitance	$f_{REF} = 20$ MHz	–	1	–	pF
R_{REF}	Reference division ratio	SA = SM = "000"	4	–	1023	
Charge pump current setting resistor input; pin 14						
R_{SET}	External resistor from pin to ground		6	7.5	15	k Ω
V_{SET}	Regulated voltage at pin	$R_{SET} = 7.5$ k Ω	–	1.25	–	V
Charge pump outputs (including fractional compensation pump); pins 8, 9, 11; $R_{SET} = 7.5$ kΩ, FC = 80						
I_{CP}	Charge pump current ratio to I_{SET}^1	Current gain = I_{PH}/I_{SET}	–15		+15	%
I_{MATCH}	Sink-to-source current matching	$V_{PH} = 1/2 V_{DDCP}$	–10		+10	%
I_{ZOUT}	Output current variation versus V_{PH}^2	V_{PH} in compliance range	–10		+10	%
I_{LPH}	Charge pump off leakage current	$V_{PH} = 1/2 V_{DDCP}$	–10		+10	nA
V_{PH}	Charge pump voltage compliance		0.7	–	$V_{DDCP}-0.8$	V

1.3GHz low voltage fractional-N dual synthesizer

SA7026

CHARACTERISTICS (CONTINUED)

SYMBOL	PARAMETER	CONDITIONS	MIN.	TYP.	MAX.	UNIT
Phase noise (condition R_{SET} = 7.5 kΩ, CP = 00)						
C/N	Synthesizer's contribution to close-in phase noise of 800 MHz RF signal at 1 kHz offset.	f _{REF} = 19.44MHz, TCXO, f _{COMP} = 240kHz indicative, not tested	-	-85	-	dBc/Hz
	Synthesizer's contribution to close-in phase noise of 960 MHz RF signal at 1 kHz offset.		-	-84	-	dBc/Hz
Interface logic input signal levels; pins 17, 18, 19, 20						
V _{IH}	HIGH level input voltage		0.7*V _{DD}	-	V _{DD} +0.3	V
V _{IL}	LOW level input voltage		-0.3	-	0.3*V _{DD}	V
I _{LEAK}	Input leakage current	logic 1 or logic 0	-0.5	-	+0.5	μA
Lock detect output signal (in push/pull mode); pin 1						
V _{OL}	LOW level output voltage	I _{sink} = 2mA	-	-	0.4	V
V _{OH}	HIGH level output voltage	I _{source} = -2mA	V _{DD} -0.4	-	-	V

NOTES:

1. $I_{SET} = \frac{V_{SET}}{R_{SET}}$ bias current for charge pumps.

2. The relative output current variation is defined as:

$$\frac{\Delta I_{OUT}}{I_{OUT}} = 2 \cdot \frac{(I_2 - I_1)}{I(I_2 + I_1)}; \text{ with } V_1 = 0.7V, V_2 = V_{DDCP} - 0.8V \text{ (See Figure 3.)}$$

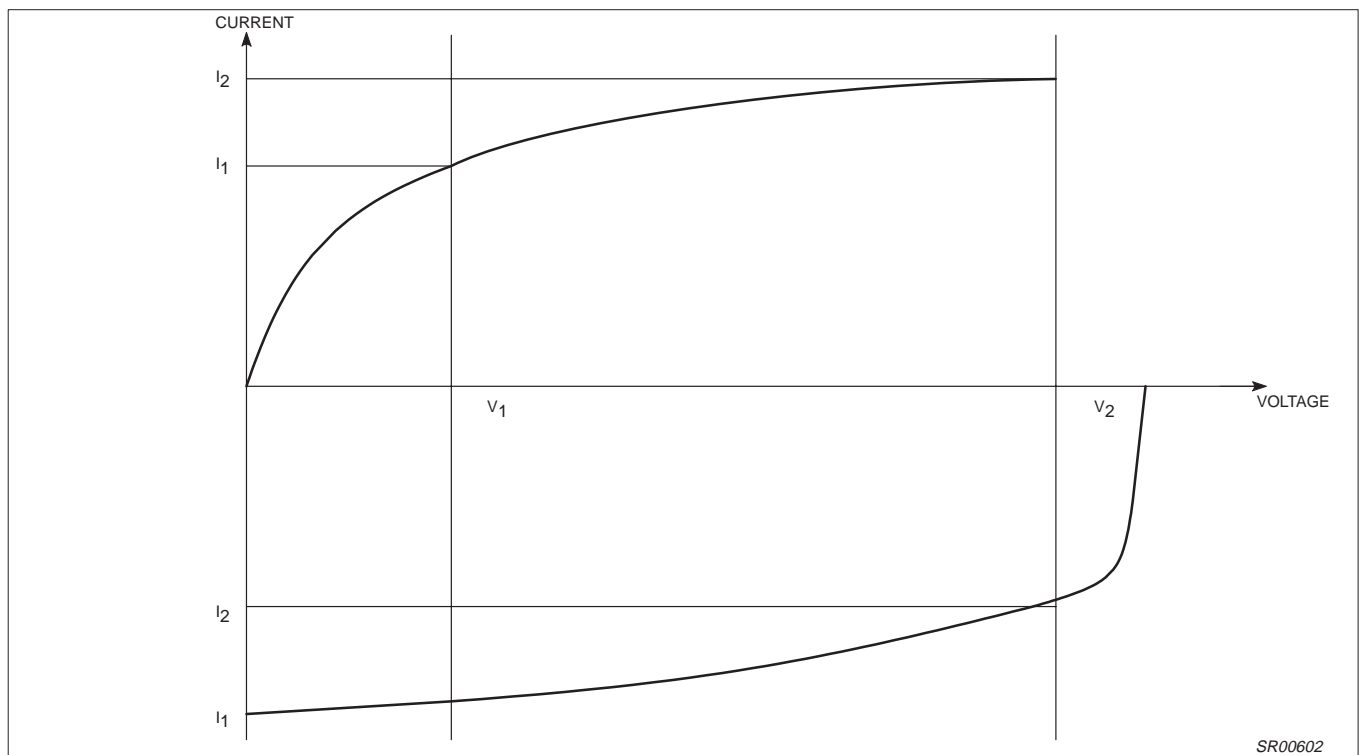

Figure 3. Relative Output Current Variation

1.3GHz low voltage fractional-N dual synthesizer

SA7026

FUNCTIONAL DESCRIPTION

Main Fractional-N divider

The RFin inputs drive a pre-amplifier to provide the clock to the first divider stage. For single ended operation, the signal should be fed to one of the inputs while the other one is AC grounded. The pre-amplifier has a high input impedance, dominated by pin and pad capacitance. The circuit operates with signal levels from -18dBm to 0dBm, and at frequencies as high as 1.3 GHz. The divider consists of a fully programmable bipolar prescaler followed by a CMOS counter. Total divide ratios range from 512 to 65536.

At the completion of a main divider cycle, a main divider output pulse is generated which will drive the main phase comparator. Also, the fractional accumulator is incremented by the value of NF. The accumulator works with modulo Q set by FMOD. When the accumulator overflows, the overall division ratio N will be increased by 1 to N + 1, the average division ratio over Q main divider cycles (either 5 or 8) will be

$$N_{frac} = N + \frac{NF}{Q}$$

The output of the main divider will be modulated with a fractional phase ripple. The phase ripple is proportional to the contents of the fractional accumulator and is nulled by the fractional compensation charge pump.

The reloading of a new main divider ratio is synchronized to the state of the main divider to avoid introducing a phase disturbance.

Auxiliary divider

The AUXin input drives a pre-amplifier to provide the clock to the first divider stage. The pre-amplifier has a high input impedance, dominated by pin and pad capacitance. The circuit operates with signal levels from -18dBm to 0dBm (80 to 636 mVpp), and at frequencies as high as 550 MHz. The divider consists of a fully programmable bipolar prescaler followed by a CMOS counter.

Reference divider

The reference divider consists of a divider with programmable values between 4 and 1023 followed by a three bit binary counter. The 3 bit SM (SA) register (see figure 4) determines which of the 5 output pulses are selected as the main (auxiliary) phase detector input.

Phase detector (see Figure 5)

The reference and main (aux) divider outputs are connected to a phase/frequency detector that controls the charge pump. The pump current is set by an external resistor in conjunction with control bits CP0 and CP1 in the C-word (see Charge Pump table). The dead zone (caused by finite time taken to switch the current sources on or off) is cancelled by forcing the pumps ON for a minimum time at every cycle (backlash time) providing improved linearity.

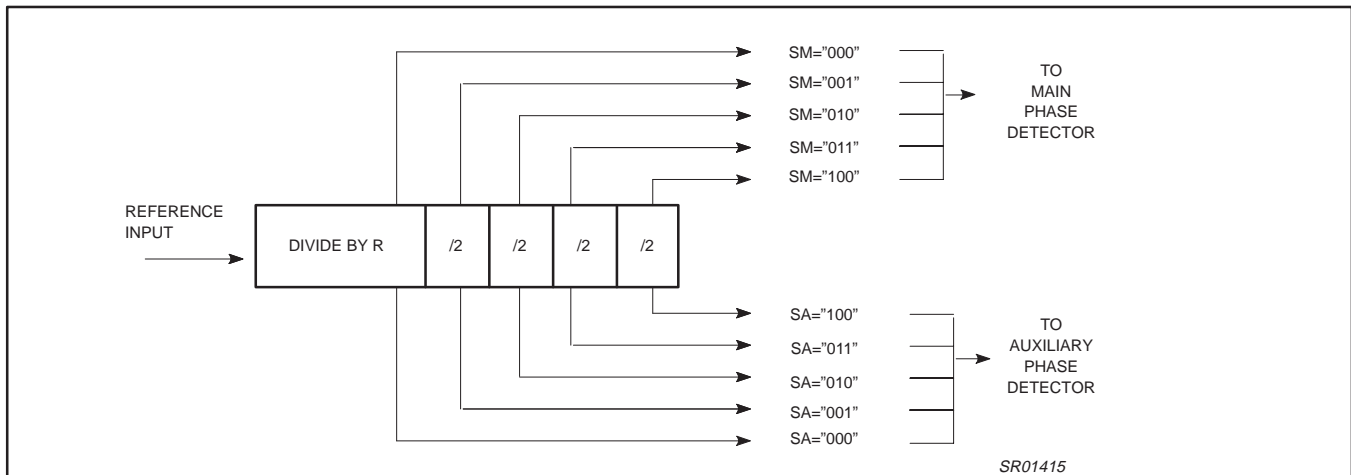

Figure 4. Reference Divider

1.3GHz low voltage fractional-N dual synthesizer

SA7026

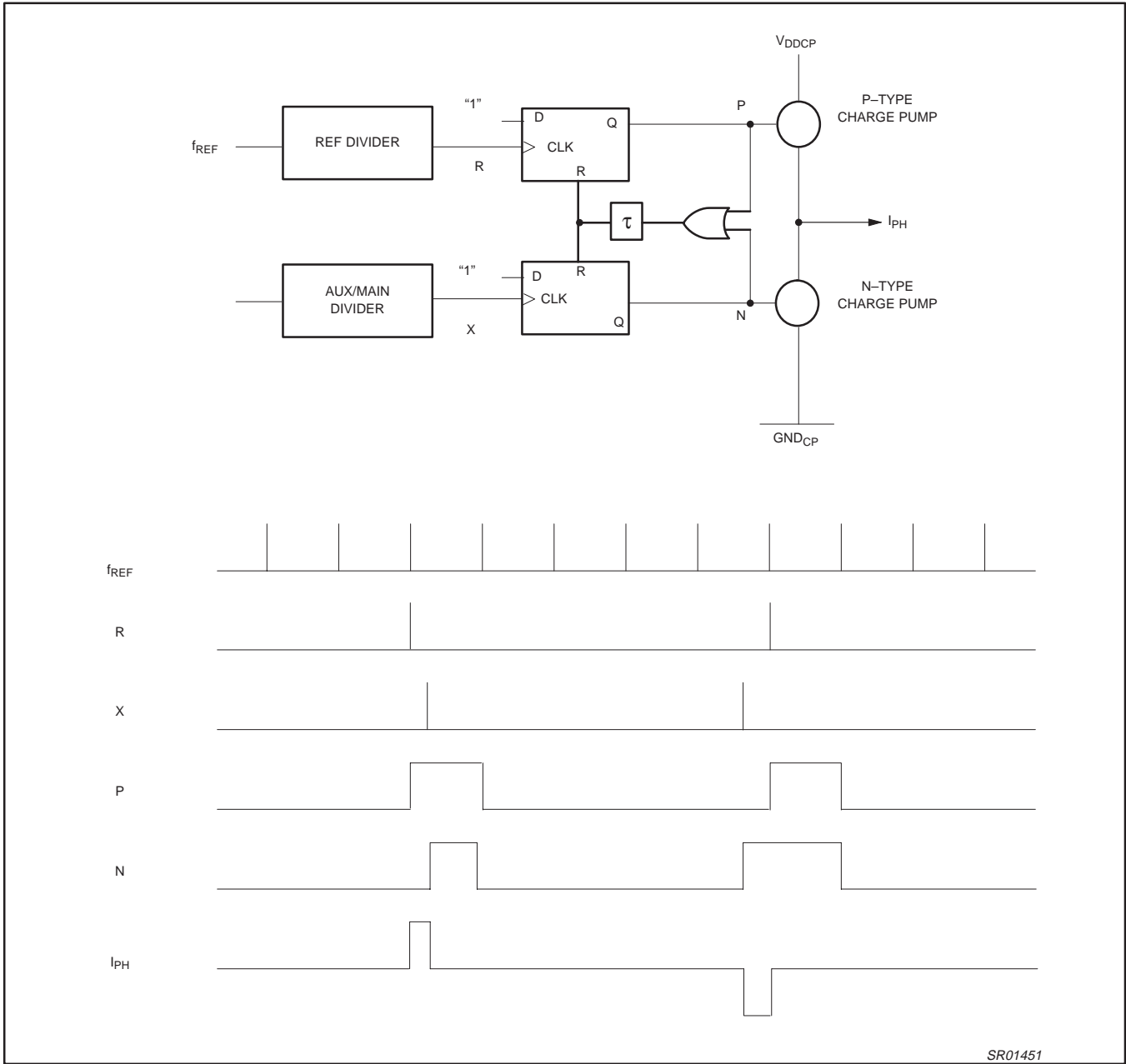

Figure 5. Phase Detector Structure with Timing

SR01451

1.3GHz low voltage fractional-N dual synthesizer

SA7026

Main Output Charge Pumps and Fractional Compensation Currents (see Figure 6)

The main charge pumps on pins PHP and PHI are driven by the main phase detector and the charge pump current values are determined by the current at pin R_{SET} in conjunction with bits CP0, CP1 in the B-word (see table of charge pump ratios). The fractional compensation is derived from the current at R_{SET}, the contents of the fractional accumulator FRD and by the program value of the FDAC. The timing for the fractional compensation is derived from the main divider. The main charge pumps will enter speed up mode after the A-word is set and strobe goes High. When strobe goes Low, charge pump will exit speed up mode.

Principle of Fractional Compensation

The fractional compensation is designed into the circuit as a means of reducing or eliminating fractional spurs that are caused by the fractional phase ripple of the main divider. If I_{COMP} is the compensation current and I_{PUMP} is the pump current, then for each charge pump:

The compensation is done by sourcing a small current, I_{COMP}, see Figure 7, that is proportional to the fractional error phase. For proper fractional compensation, the area of the fractional compensation current pulse must be equal to the area of the fractional charge pump ripple. The width of the fractional compensation pulse is fixed to 128 VCO cycles, the amplitude is proportional to the fractional accumulator value and is adjusted by FDAC values (bits FC7–0 in the B-word). The fractional compensation current is derived from the main charge pump in that it follows all the current scaling through external resistor setting, R_{SET}, programming or speed-up operation. For a given charge pump,

$$I_{COMP} = (I_{PUMP} / 128) * (FDAC / 5 * 128) * FRD$$

FRD is the fractional accumulator value.

The target values for FDAC are: 128 for F_{MOD} = 1 (modulo 5) and 80 for F_{MOD} = 0 (modulo 8).

$$I_{PUMP_TOTAL} = I_{PUMP} + I_{COMP}$$

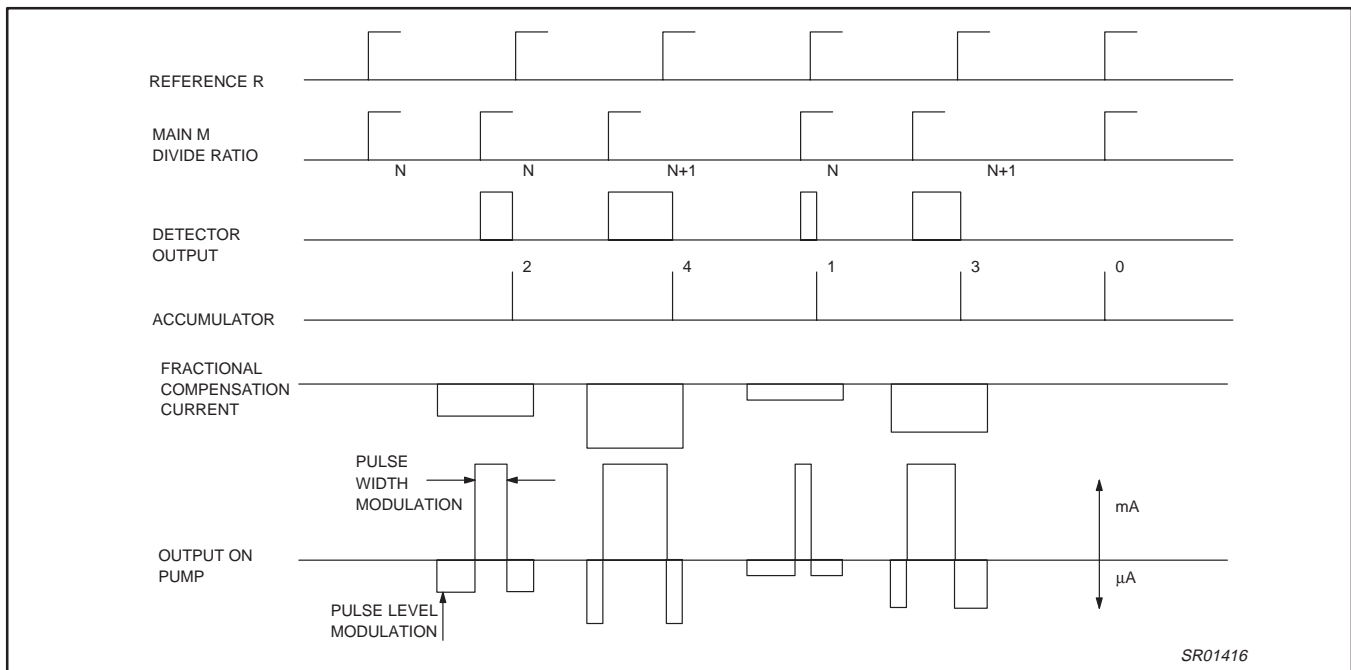

NOTE: For a proper fractional compensation, the area of the fractional compensation current pulse must be equal to the area of the charge pump ripple output.

Figure 6. Waveforms for NF = 2 Modulo 5 → fraction = 2/5

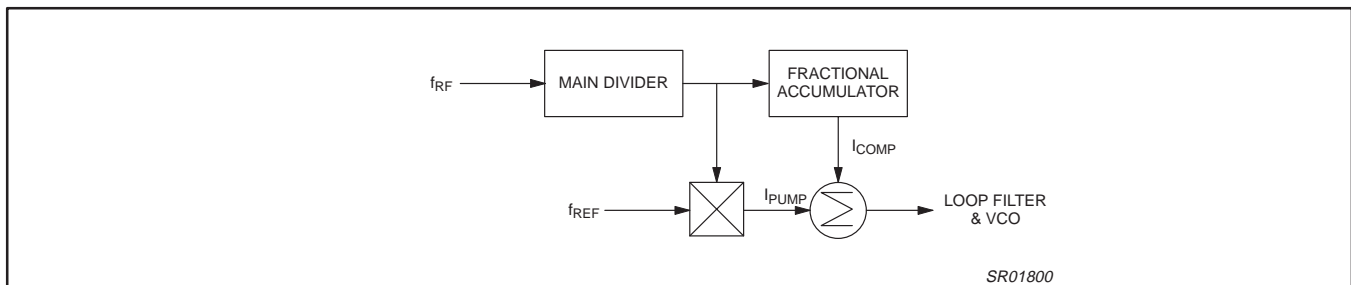

Figure 7. Current Injection Concept

1.3GHz low voltage fractional-N dual synthesizer

SA7026

Auxiliary Output Charge Pumps

The auxiliary charge pump on pin PHA are driven by the auxiliary phase detector and PHP, PHI are driven by the main phase detector. The current value is determined by the external resistor attached to pin R_{SET}.

Main and auxiliary charge pump currents

CP1	CP0	I _{PHA}	I _{PHP}	I _{PHP-SU}	I _{PHI}
0	0	1.5xI _{SET}	3xI _{SET}	15xI _{SET}	36xI _{SET}
0	1	0.5xI _{SET}	1xI _{SET}	5xI _{SET}	12xI _{SET}
1	0	1.5xI _{SET}	3xI _{SET}	15xI _{SET}	0
1	1	0.5xI _{SET}	1xI _{SET}	5xI _{SET}	0

NOTES

1. $I_{SET} = V_{SET}/R_{SET}$; bias current for charge pumps.
2. CP1 is used to disable the PHI pump, I_{PHP-SU} is the total current at pin PHP during speed up condition.

Lock Detect

The output LOCK maintains a logic '1' when the auxiliary phase detector ANDed with the main phase detector indicates a lock condition. The lock condition for the main and auxiliary synthesizers is defined as a phase difference of less than ± 1 period of the frequency at the input REF_{in+}, ... One counter can fulfill the lock condition when the other counter is powered down. Out of lock (logic '0') is indicated when both counters are powered down.

Power-down mode

The power-down signal can be either hardware (PON) or software (PD). The PON signal is exclusively ORed with the PD bits in B-word. If PON = 0, then the part is powered up when PD = 1. PON can be used to invert the polarity of the software bit PD. When the synthesizer is reactivated after power-down, the main and reference dividers are synchronized to avoid possibility of random phase errors on power-up.

1.3GHz low voltage fractional-N dual synthesizer

SA7026

Serial programming bus

The serial input is a 3-wire input (CLOCK, STROBE, DATA) to program all counter divide ratios, fractional compensation DAC, selection and enable bits. The programming data is structured into 24 bit words; each word includes 2 or 3 address bits. Figure 8 shows the timing diagram of the serial input. When the STROBE goes active HIGH, the clock is disabled and the data in the shift register remains unchanged. Depending on the address bits, the

data is latched into different working registers or temporary registers. In order to fully program the synthesizer, 3 words must be sent: C, B, and A. Table 1 shows the format and the contents of each word. The D word is normally used for testing purposes. When sending the B-word, data bits FC7-0 for the fractional compensation DAC are not loaded immediately. Instead they are stored in temporary registers. Only when the A-word is loaded, these temporary registers are loaded together with the main divider ratio.

Serial bus timing characteristics. See Figure 8.

$V_{DD} = V_{DDCP} = +3.0V$; $T_A = +25^\circ C$ unless otherwise specified.

SYMBOL	PARAMETER	MIN.	TYP.	MAX.	UNIT
Serial programming clock; CLK					
t_r	Input rise time	–	10	40	ns
t_f	Input fall time	–	10	40	ns
T_{cy}	Clock period	100	–	–	ns
Enable programming; STROBE					
t_{START}	Delay to rising clock edge	40	–	–	ns
t_w	Minimum inactive pulse width	$1/f_{COMP}$	–	–	ns
$t_{SU;E}$	Enable set-up time to next clock edge	20	–	–	ns
Register serial input data; DATA					
$t_{SU;DAT}$	Input data to clock set-up time	20	–	–	ns
$t_{HD;DAT}$	Input data to clock hold time	20	–	–	ns

Application information

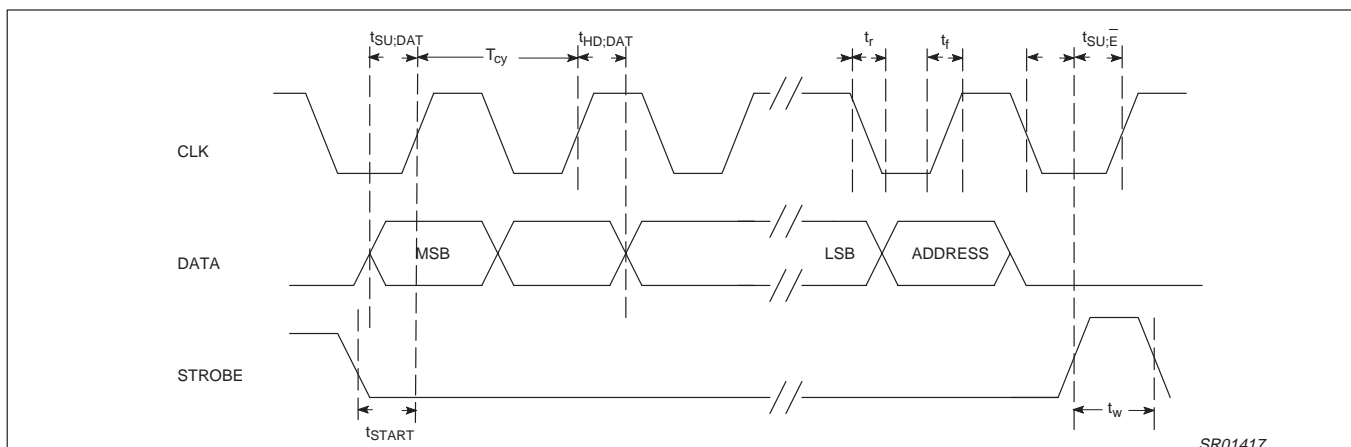

Figure 8. Serial Bus Timing Diagram

SR01417

1.3GHz low voltage fractional-N dual synthesizer

SA7026

Data format

Table 1. Format of programmed data

Last In		MSB	Serial Programming Format				First In LSB
p23	p22	p21	p20	../..	../..	p1	p0

Table 2. A word, length 24 bits

Last In																				MSB																				LSB	First In
Address	fmod	Fractional-N				Main Divider ratio																Spare																			
0	0	FM	NF2	NF1	NF0	N15	N14	N13	N12	N11	N10	N9	N8	N7	N6	N5	N4	N3	N2	N1	N0	SK1	SK2																		
Default	0	0	1	0	0	0	1	0	0	0	1	0	0	0	1	1	0	0	0	0	0	0	0																		
A word select		Fixed to 00.																																							
Fractional Modulus select		FM 0 = modulo 8, 1 = modulo 5.																																							
Fractional-N Increment		NF2..0 Fractional N Increment values 000 to 111.																																							
N-Divider		N0..N15, Main divider values 512 to 65535 allowed for divider ratio.																																							

Table 3. B word, length 24 bits

Address		Reference Divider										Lock		PD		Fractional Compensation DAC							
0	1	R9	R8	R7	R6	R5	R4	R3	R2	R1	R0	L1	L0	Main	Aux	FC7	FC6	FC5	FC4	FC3	FC2	FC1	FC0
Default	0	0	0	1	0	1	0	0	0	1	0	0	1	1	0	1	0	1	0	0	0	0	0
B word select		Fixed to 01																					
R-Divider		R0..R9, Reference divider values 4 to 1023 allowed for divider ration.																					
Lock detect output		L1 L0 0 0 Combined main, aux. lock detect signal present at the LOCK pin (push/pull). 0 1 Combined main, aux, lock detect signal present at the LOCK pin (open drain). 1 0 Main lock detect signal present at the LOCK pin (push/pull). 1 1 Auxiliary loop lock detect signal present at the LOCK pin (push/pull). When auxiliary loop and main loop are in power down mode, the lock indicator is low.																					
Power down		Main = 1: power to N-divider, reference divider, main charge pumps, Main = 0 to power down. Aux = 1: power to Aux divider, reference divider, aux charge pump, Aux = 0 to power down.																					
Fractional Compensation		FC7..0 Fractional Compensation charge pump current DAC, values 0 to 255.																					

Table 4. C word, length 24 bits

Address		Auxiliary Divider													CP		SM			SA			
1	0	A13	A12	A11	A10	A9	A8	A7	A6	A5	A4	A3	A2	A1	A0	CP1	CP0	SM2	SM1	SM0	SA2	SA1	SA0
Default	0	0	0	0	0	1	1	1	0	0	1	0	1	0	1	1	0	0	0	0	0	0	0
C word select		Fixed to 10																					
A-Divider		A0..A13, Auxiliary divider values 128 to 16384 allowed for divider ratio.																					
Charge pump current Ratio		CP1, CP0: Charge pump current ratio, see table of charge pump currents.																					
Main comparison select		SM comparison divider select for main phase detector.																					
Aux comparison select		SA Comparison divider select for auxiliary phase detector.																					

Table 5. D word, length 24 bits

Address		Synthesizer Test Bits					Synthesizer Test Bits																		
1	1	0	-	-	-	-	Tspu	-	-	-	-	-	-	-	-	-	-	-	-	-	-	-	-		
Default	0	0	0	0	0	0	0	0	0	0	0	0	0	0	0	0	0	0	0	0	0	0	0		
Tspu: Speed up = 1		Forces the main charge pumps in speed-up mode all the time. NOTE: All test bits must be set to 0 for normal operation.																							

1.3GHz low voltage fractional-N dual synthesizer

SA7026

TYPICAL PERFORMANCE CHARACTERISTICS

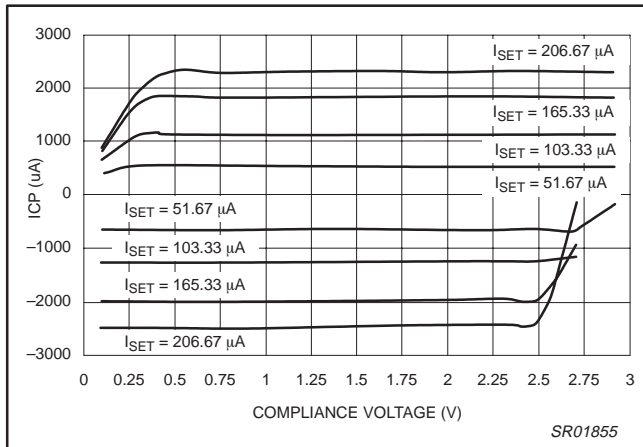

Figure 9. PHI Charge Pump vs. I_{SET}
(CP = 01; Temp = 25°C)

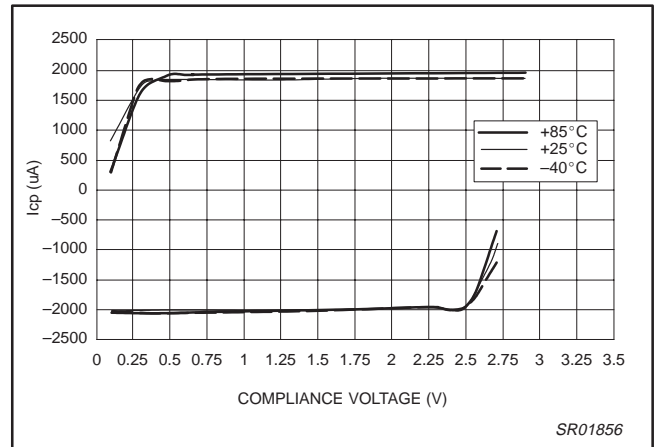

Figure 10. PHI Charge Pump Output vs. Temperature
(CP = 01; V_{DD} = 3.0 V; I_{SET} = 165.33 µA)

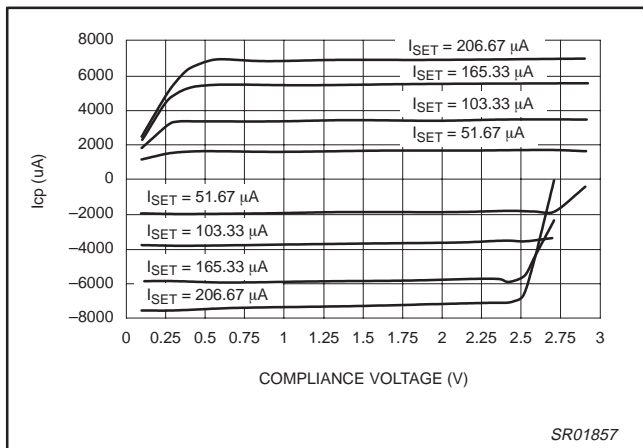

Figure 11. PHI Charge Pump vs. I_{SET}
(CP = 00; TEMP = 25°C)

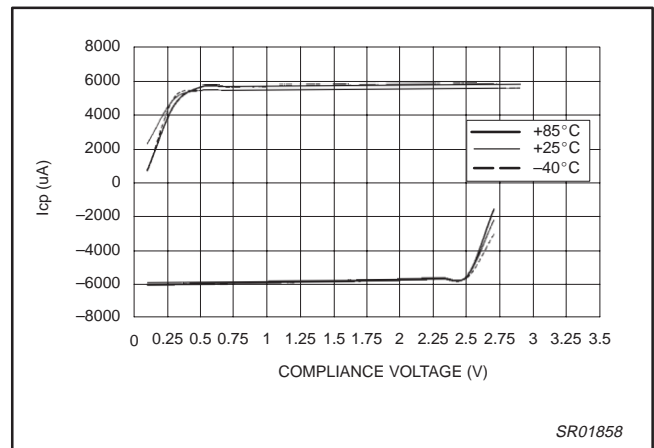

Figure 12. PHI Charge Pump Output vs. Temperature
(CP = 00; V_{DD} = 3.0 V; I_{SET} = 165.33 µA)

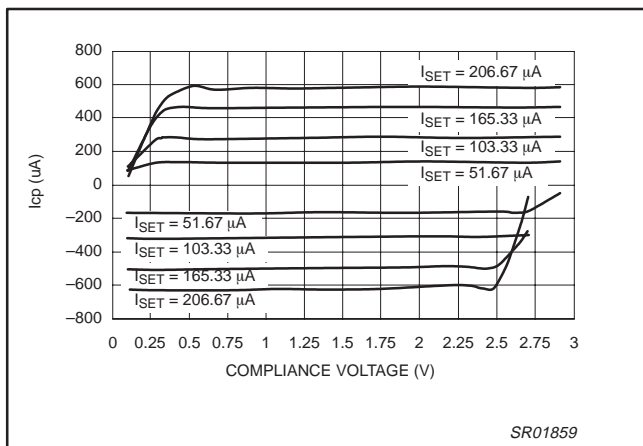

Figure 13. PHP Charge Pump Output vs. I_{SET}
(CP = 10; Temp = 25°C)

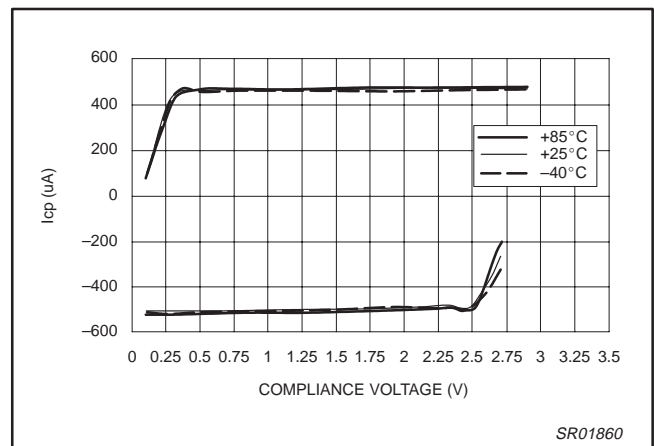

Figure 14. PHP Charge Pump Output vs. Temperature
(CP = 10; V_{DD} = 3.0 V; I_{SET} = 165.33 µA)

1.3GHz low voltage fractional-N dual synthesizer

SA7026

TYPICAL PERFORMANCE CHARACTERISTICS (Continued)

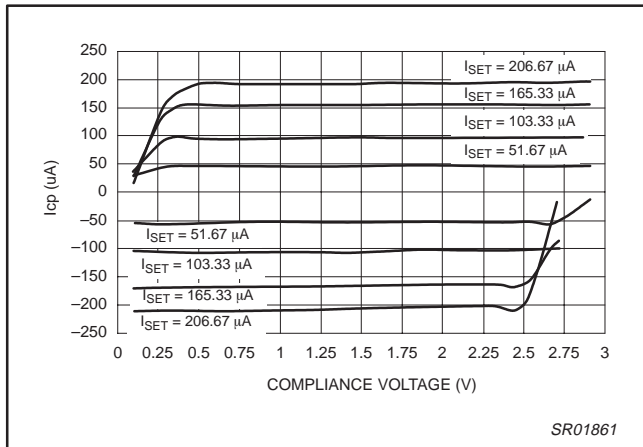

Figure 15. PHP Charge Pump Output vs. I_{SET}
(CP = 11; Temp = 25°C)

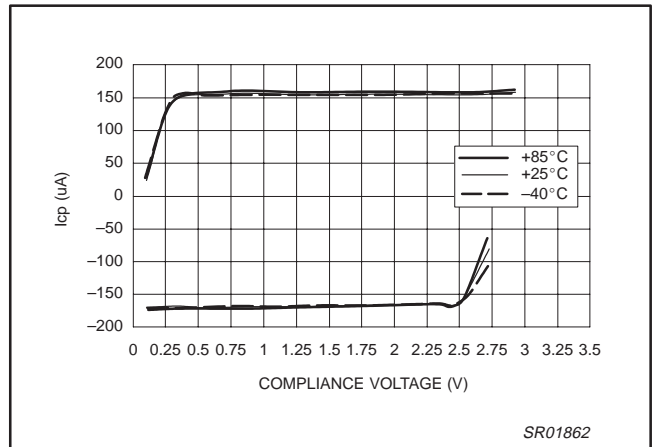

Figure 16. PHP Charge Pump Output vs. Temperature
(CP = 11; V_{DD} = 3.0 V; I_{SET} = 165.33 μ A)

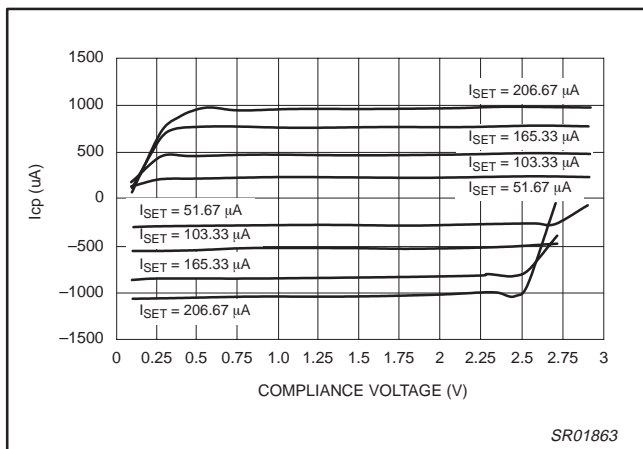

Figure 17. PHP-SU Charge Pump Output vs. I_{SET}
(CP = 01; Temp = 25°C)

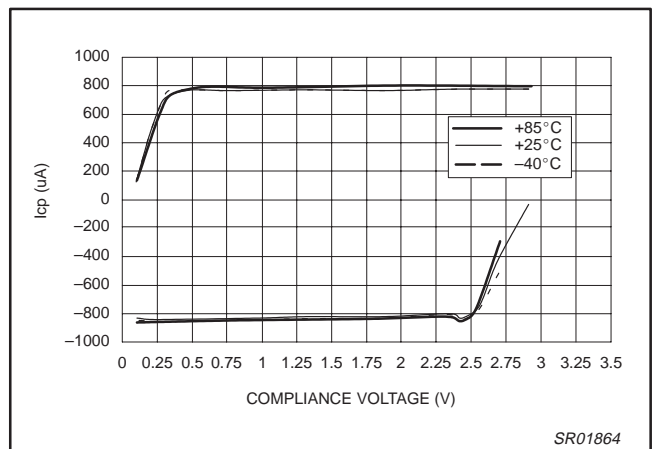

Figure 18. PHP-SU Charge Pump Output vs. Temperature
(CP = 01; V_{DD} = 3.0 V; I_{SET} = 165.33 μ A)

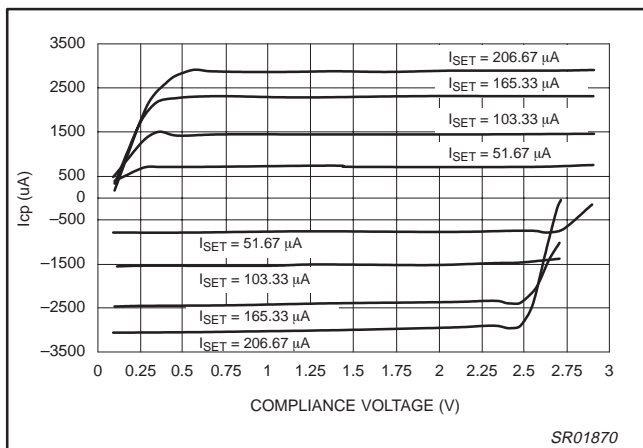

Figure 19. PHP-SU Charge Pump Output vs. I_{SET}
(CP = 00; Temp = 25°C)

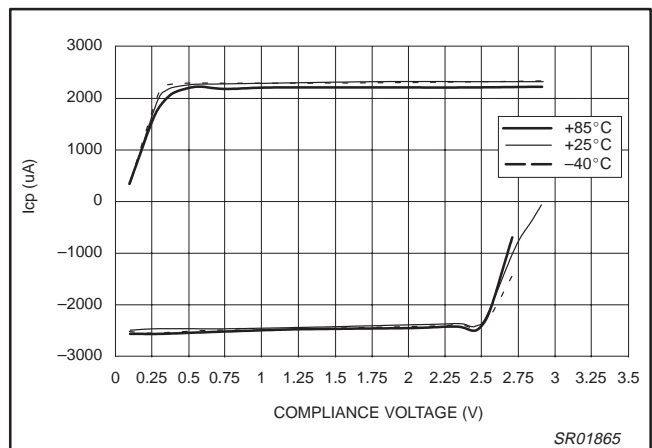

Figure 20. PHP-SU Charge Pump Output vs. Temperature
(CP = 00; V_{DD} = 3.0 V; I_{SET} = 165.33 μ A)

1.3GHz low voltage fractional-N dual synthesizer

SA7026

TYPICAL PERFORMANCE CHARACTERISTICS (Continued)

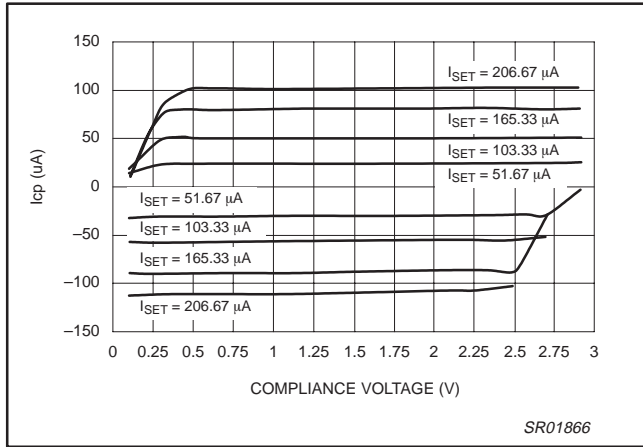

Figure 21. PHA Charge Pump Output vs. I_{SET}
(CP = 11; Temp = 25°C)

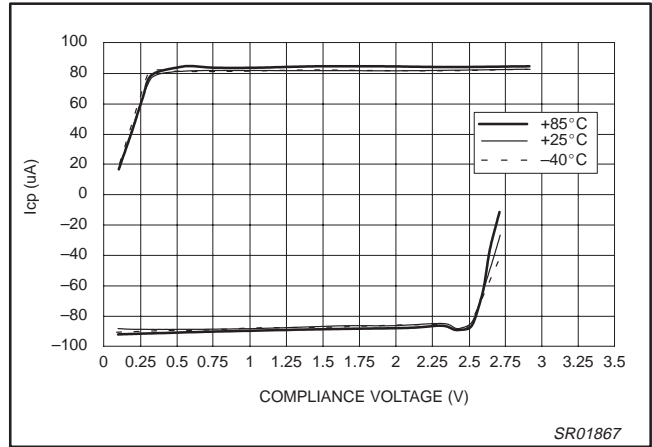

Figure 22. PHA Charge Pump Output vs. Temperature
(CP = 11; V_{DD} = 3.0 V; I_{SET} = 165.33 μ A)

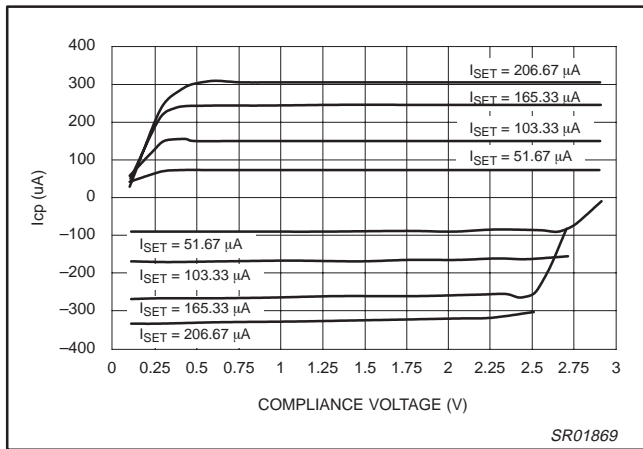

Figure 23. PHA Charge Pump Output vs. I_{SET}
(CP = 10; Temp = 25°C)

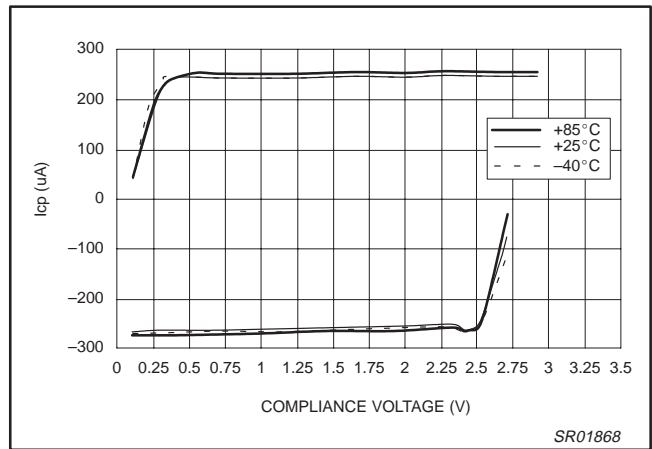

Figure 24. PHA Charge Pump Output vs. Temperature
(CP = 10; V_{DD} = 3.0 V; I_{SET} = 165.33 μ A)

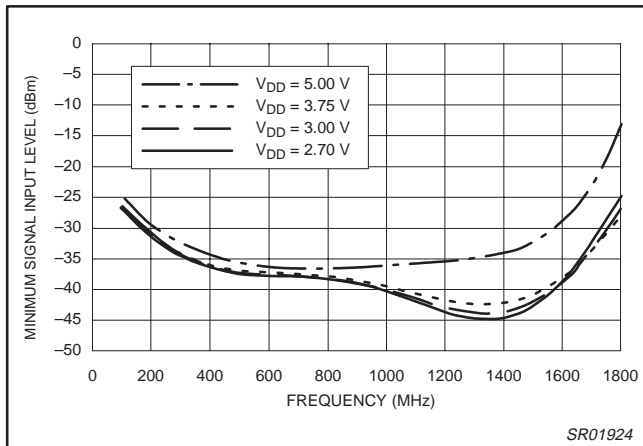

Figure 25. Main Divider Input Sensitivity vs. Frequency and Supply Voltage
(Temp = 25°C)

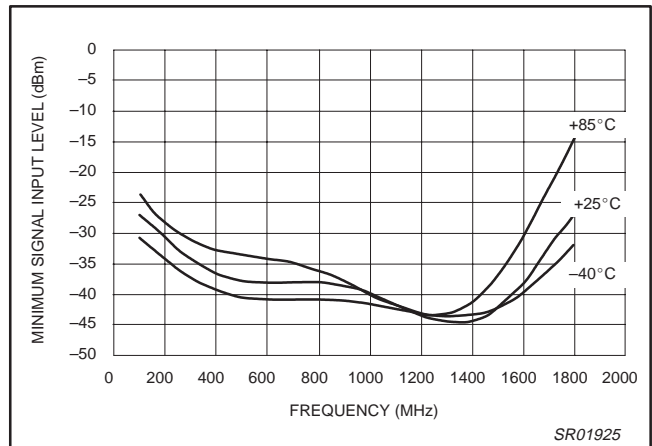

Figure 26. Main Divider Input Sensitivity vs. Frequency and Temperature
(V_{DD} = 3.00 V)

1.3GHz low voltage fractional-N dual synthesizer

SA7026

TYPICAL PERFORMANCE CHARACTERISTICS (Continued)

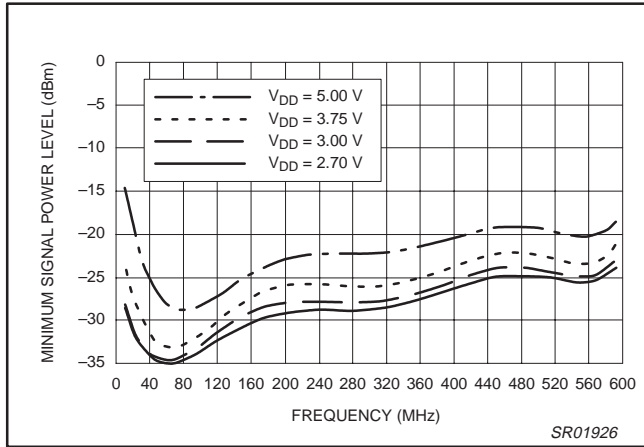

Figure 27. Auxiliary Divider Input Sensitivity vs. Frequency and Supply Voltage (Temp = 25°C)

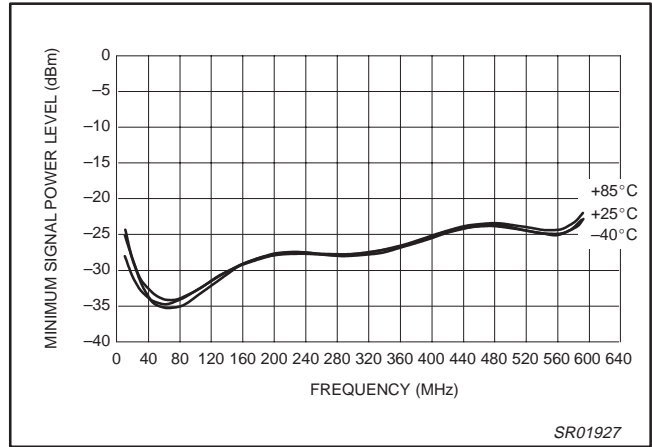

Figure 28. Auxiliary Divider Input Sensitivity vs. Frequency and Temperature (V_{DD} = 3.00 V)

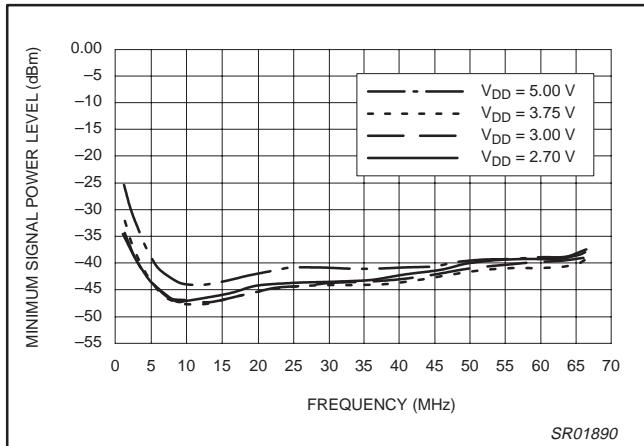

Figure 29. Reference Divider Input Sensitivity vs. Frequency and Supply Voltage (Temp = 25°C)

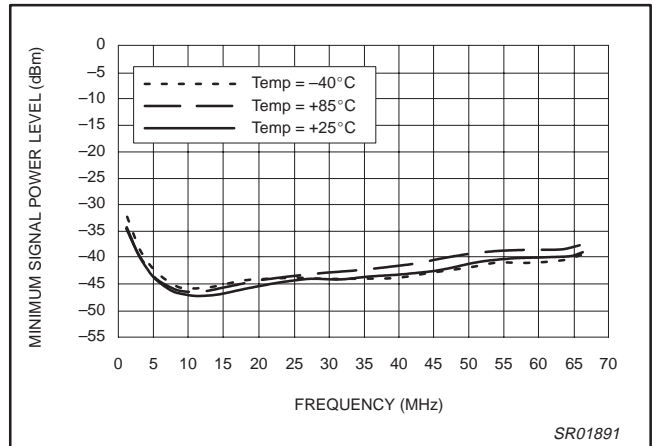

Figure 30. Reference Divider Input Sensitivity vs. Frequency and Temperature (V_{DD} = 3.00 V)

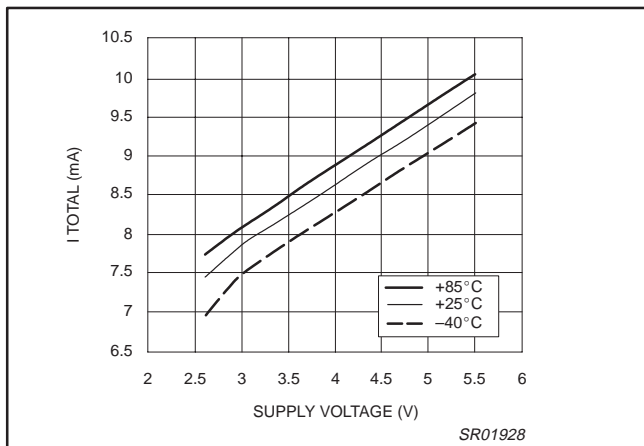

Figure 31. Current Supply Over V_{DD}

1.3GHz low voltage dual fractional-N frequency synthesizer

SA7026

TSSOP20: plastic thin shrink small outline package; 20 leads; body width 4.4 mm

SOT360-1



DIMENSIONS (mm are the original dimensions)

UNIT	A max.	A ₁	A ₂	A ₃	b _p	c	D ⁽¹⁾	E ⁽²⁾	e	H _E	L	L _p	Q	v	w	y	Z ⁽¹⁾	θ
mm	1.10	0.15 0.05	0.95 0.80	0.25	0.30 0.19	0.2 0.1	6.6 6.4	4.5 4.3	0.65	6.6 6.2	1.0	0.75 0.50	0.4 0.3	0.2	0.13	0.1	0.5 0.2	8° 0°

Notes

1. Plastic or metal protrusions of 0.15 mm maximum per side are not included.
2. Plastic interlead protrusions of 0.25 mm maximum per side are not included.

OUTLINE VERSION	REFERENCES				EUROPEAN PROJECTION	ISSUE DATE
	IEC	JEDEC	EIAJ			
SOT360-1		MO-153AC				-93-06-16 95-02-04

1.3GHz low voltage dual fractional-N frequency synthesizer

SA7026

Data sheet status

Data sheet status	Product status	Definition [1]
Objective specification	Development	This data sheet contains the design target or goal specifications for product development. Specification may change in any manner without notice.
Preliminary specification	Qualification	This data sheet contains preliminary data, and supplementary data will be published at a later date. Philips Semiconductors reserves the right to make changes at any time without notice in order to improve design and supply the best possible product.
Product specification	Production	This data sheet contains final specifications. Philips Semiconductors reserves the right to make changes at any time without notice in order to improve design and supply the best possible product.

[1] Please consult the most recently issued datasheet before initiating or completing a design.

Definitions

Short-form specification — The data in a short-form specification is extracted from a full data sheet with the same type number and title. For detailed information see the relevant data sheet or data handbook.

Limiting values definition — Limiting values given are in accordance with the Absolute Maximum Rating System (IEC 134). Stress above one or more of the limiting values may cause permanent damage to the device. These are stress ratings only and operation of the device at these or at any other conditions above those given in the Characteristics sections of the specification is not implied. Exposure to limiting values for extended periods may affect device reliability.

Application information — Applications that are described herein for any of these products are for illustrative purposes only. Philips Semiconductors make no representation or warranty that such applications will be suitable for the specified use without further testing or modification.

Disclaimers

Life support — These products are not designed for use in life support appliances, devices or systems where malfunction of these products can reasonably be expected to result in personal injury. Philips Semiconductors customers using or selling these products for use in such applications do so at their own risk and agree to fully indemnify Philips Semiconductors for any damages resulting from such application.

Right to make changes — Philips Semiconductors reserves the right to make changes, without notice, in the products, including circuits, standard cells, and/or software, described or contained herein in order to improve design and/or performance. Philips Semiconductors assumes no responsibility or liability for the use of any of these products, conveys no license or title under any patent, copyright, or mask work right to these products, and makes no representations or warranties that these products are free from patent, copyright, or mask work right infringement, unless otherwise specified.

Philips Semiconductors
811 East Arques Avenue
P.O. Box 3409
Sunnyvale, California 94088-3409
Telephone 800-234-7381

© Copyright Philips Electronics North America Corporation 1999
All rights reserved. Printed in U.S.A.

Date of release: 04-99

Document order number:

9397 750 05744

Let's make things better.