



REG1118

800mA Low Dropout Positive Regulator with Current Source and Sink Capability

FEATURES

- SOURCES 800mA, SINKS 400mA
- 2.85V OUTPUT FOR SCSI ACTIVE NEGATION TERMINATION
- 1.3V max DROPOUT VOLTAGE AT $I_o = 800\text{mA}$
- INTERNAL CURRENT LIMIT
- THERMAL OVERLOAD PROTECTION
- SOT-223 SURFACE MOUNT PACKAGE

APPLICATIONS

- SCSI-2 AND SCSI-3 DEVICES
- FAST-20 SCSI
- ACTIVE NEGATION SCSI TERMINATORS
- SUPPLY SPLITTER GROUND GENERATION

DESCRIPTION

The REG1118-2.85 is a three-terminal voltage regulators capable of sourcing up to 800mA and sinking up to 400mA. The sinking capability is important in SCSI applications where active negation line drivers are used. The REG1118-2.85 is useful for making a 27-line Boulay terminator capable of interfacing with active negation drivers required in FAST-20 SCSI applications. The regulator has active current limits for both sink and source currents as well as internal thermal limiting.

Laser trimming assures excellent output voltage accuracy. An NPN output stage allows output stage drive current to contribute to the source load current for maximum efficiency.

REG1118 is packaged in a SOT-223 surface-mount package, suitable for reflow soldering techniques.

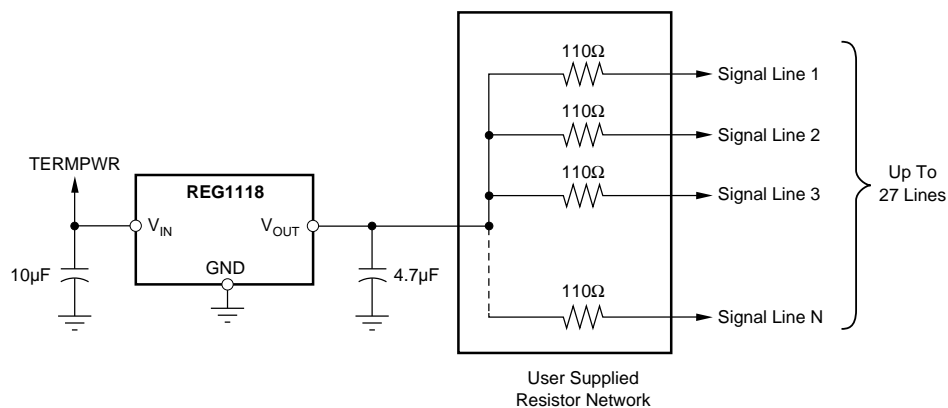

REG1118-2.85 Used to Make Active Negation SCSI Terminator

SPECIFICATIONS

At $T_A = 0^\circ\text{C}$ to 70°C , $\text{TERMPWR} = +5\text{V}$, unless otherwise noted.

PARAMETER	CONDITIONS	REG1118-2.85			UNITS
		MIN	TYP	MAX	
OUTPUT VOLTAGE	No Load, $T_A = 25^\circ\text{C}$ All Operating Conditions ⁽¹⁾	2.82	2.85	2.88	V
		2.79	2.85	2.91	V
LINE REGULATION ⁽²⁾	$I_O = 0$, $V_{IN} = 4.75\text{V}$ to 6V		0.3	4	mV
LOAD REGULATION ⁽²⁾	$I_O = 0$ to 800mA $I_O = -400$ to 0mA		2	25	mV
			25	60	mV
DROPOUT VOLTAGE ⁽³⁾	$T_A = 25^\circ\text{C}$ $I_O = 100\text{mA}$ $I_O = 800\text{mA}$		0.8	1.1	V
			1.1	1.3	V
CURRENT LIMIT Positive (I_{SC+}) ⁽⁴⁾ Negative (I_{SC-})	$T_A = 25^\circ\text{C}$ $V_{OUT} = 3.7\text{V}$	800	1450		mA
			-750	-400	mA
QUIESCENT CURRENT	$I_O = 0$		3	7	mA
RIPPLE REJECTION	$T_A = 25^\circ\text{C}$ $f = 120\text{Hz}$, $V_{IN} - V_{OUT} = 2\text{V}$, $V_{RIPPLE} = 0.5\text{Vp-p}$		56		dB
LONG-TERM STABILITY	$T_A = +125^\circ\text{C}$, 1000Hr		0.2		%
THERMAL SHUTDOWN Junction Temperature Shutdown Junction Temperature Reset			150		$^\circ\text{C}$
			140		$^\circ\text{C}$
THERMAL RESISTANCE Specified Junction Temperature Range Operating Junction Temperature Range Storage Range Thermal Resistance θ_{JC}	(Junction-to-Case at Tab)	0		70	$^\circ\text{C}$
		0		125	$^\circ\text{C}$
		-55		125	$^\circ\text{C}$
			15		$^\circ\text{C/W}$

NOTES: (1) All operating conditions include the combined effects of load current, input voltage, and temperature over each parameter's full specified range. (2) Load and line regulation are tested at a constant junction temperature by low duty cycle testing. (3) Dropout voltage is defined as the minimum input-to-output voltage that produces a 1% decrease in output voltage. (4) V_{OUT} to ground through 1Ω .

ABSOLUTE MAXIMUM RATINGS

Input Voltage	7V
Output Voltage	-0.2V to (V+) +0.5V
Short-Circuit Duration	Indefinite
Operating Junction Temperature Range	0°C to $+125^\circ\text{C}$
Storage Temperature Range	-55°C to $+125^\circ\text{C}$
Lead Temperature (soldering, 10s) ⁽¹⁾	$+300^\circ\text{C}$

NOTE: (1) See "Soldering Methods."

PACKAGE INFORMATION

PRODUCT	PACKAGE	PACKAGE DRAWING NUMBER ⁽¹⁾
REG1118-2.85	SOT-223	311

NOTE: (1) For detailed drawing and dimension table, please see end of data sheet, or Appendix C of Burr-Brown IC Data Book.

ORDERING INFORMATION

PRODUCT ⁽¹⁾	PART MARKING	PACKAGE
REG1118-2.85	BB11182	SOT-223

NOTE: (1) Available in Tape and Reel, add -TR to Model Number.

CONNECTION DIAGRAM

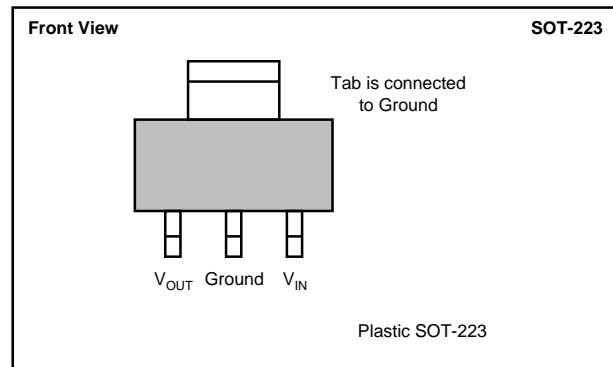

ELECTROSTATIC DISCHARGE SENSITIVITY

This integrated circuit can be damaged by ESD. Burr-Brown recommends that all integrated circuits be handled with appropriate precautions. Failure to observe proper handling and installation procedures can cause damage.

TYPICAL PERFORMANCE CURVE

At $T_A = 25^\circ\text{C}$, $\text{TERMPWR} = +5\text{V}$, unless otherwise specified.

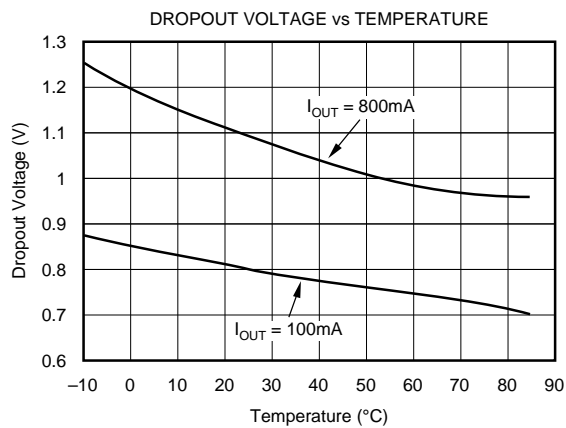
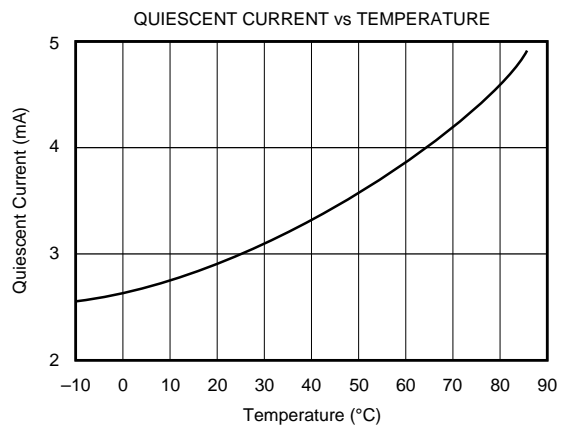
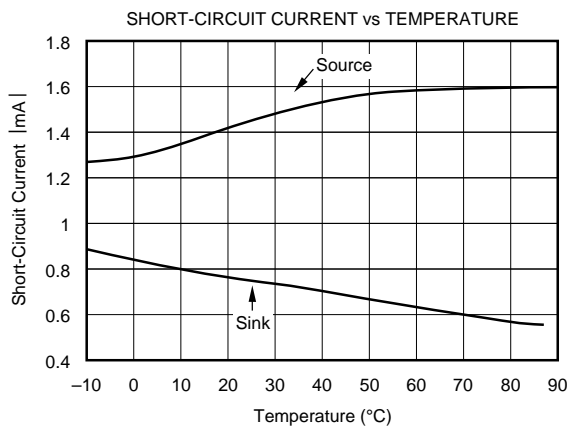
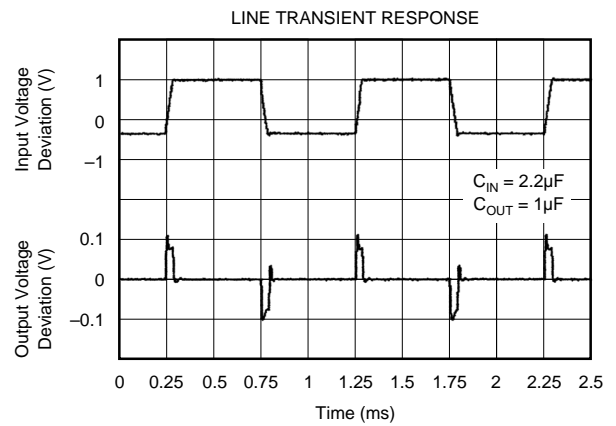
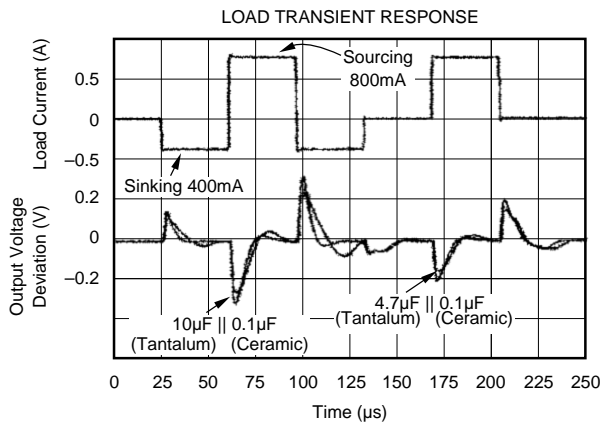

APPLICATIONS INFORMATION

Figure 1 shows the basic hookup diagram for the REG1118. An output capacitor is required for proper operation and to improve high frequency load regulation. A high quality capacitor should be used to assure that the ESR (effective series resistance) is less than 0.5Ω. A capacitor of at least 1μF is recommended. Increasing C_{OUT} improves output voltage deviation, see the typical curve “Load Transient Response.” It is suggested that the input be decoupled with 10μF low ESR capacitor.

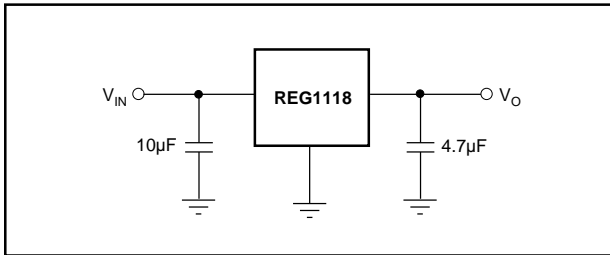

FIGURE 1. Basic Connections.

THERMAL CONSIDERATIONS

The REG1118 has current limit and thermal shutdown circuits that protect it from overload. The thermal shutdown activates at approximately T_J = 150°C. For continuous operation, however, the junction temperature should not be allowed to exceed 125°C. Any tendency to activate the thermal shutdown in normal use is an indication of an inadequate heat sink or excessive power dissipation. The power dissipation is equal to:

$$P_D = (V_{IN} - V_{OUT}) I_{OUT}$$

The junction temperature can be calculated by:

$$T_J = T_A + P_D (\theta_{JA})$$

where T_A is the ambient temperature, and
θ_{JA} is the junction-to-ambient thermal resistance

The REG1118 derives heat sinking from conduction through its copper leads, especially the large mounting tab. These must be soldered to a circuit board with a substantial amount of copper remaining (see Figure 2). Circuit board traces connecting to the tab and the leads should be made as large as practical. Other nearby circuit traces, including those on the back side of the circuit board, help conduct heat away from the device, even though they are not electrically connected. Make all nearby copper traces as wide as possible and leave only narrow gaps between traces. In addition, multiple contacts to internal power and ground planes increase heat sinking with minimal increase in circuit board area.

Table I shows approximate values of θ_{JA} for various circuit board and copper areas. Nearby heat dissipating components, circuit board mounting conditions and ventilation can dramatically affect the actual θ_{JA}.

A simple experiment will determine whether the maximum recommended junction temperature is exceeded in an actual circuit board and mounting configuration: Increase the

ambient temperature above that expected in normal operation until the device’s thermal shutdown is activated. If this occurs at more than 40°C above the maximum expected ambient temperature, then the T_J will be less than 125°C during normal operation.

SOLDERING METHODS

The REG1118 package is suitable for infrared reflow and vapor-phase reflow soldering techniques. The high rate of temperature change that occurs with wave soldering, or hand soldering can damage the REG1118.

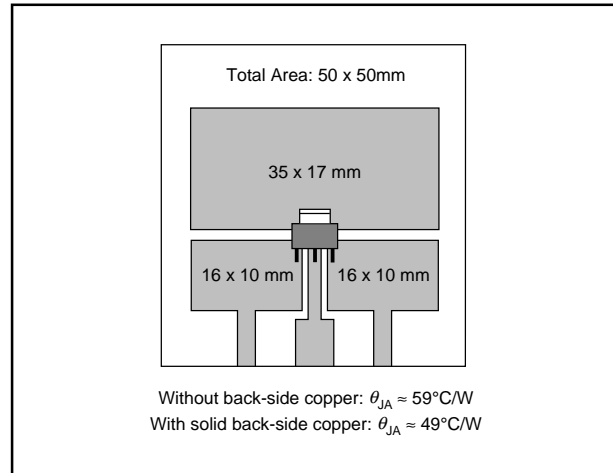

FIGURE 2. Circuit Board Layout Example.

TOTAL PC BOARD AREA	TOPSIDE ⁽¹⁾ COPPER AREA	BACKSIDE COPPER AREA	THERMAL RESISTANCE JUNCTION-TO-AMBIENT
2500mm ²	2500mm ²	2500mm ²	46°C/W
2500mm ²	1250mm ²	2500mm ²	47°C/W
2500mm ²	950mm ²	2500mm ²	49°C/W
2500mm ²	2500mm ²	0	51°C/W
2500mm ²	1800mm ²	0	53°C/W
1600mm ²	600mm ²	1600mm ²	55°C/W
2500mm ²	1250mm ²	0	58°C/W
2500mm ²	915mm ²	0	59°C/W
1600mm ²	600mm ²	0	67°C/W
900mm ²	340mm ²	900mm ²	72°C/W
900mm ²	340mm ²	0	85°C/W

NOTE: (1) Tab is attached to the topside copper.

TABLE I.

INSPEC Abstract Number: B91007604, C91012627
Kelly, E.G. “Thermal Characteristics of Surface 5WK9Ω Packages.” The Proceedings of SMTCON. Surface Mount Technology Conference and Exposition: *Competitive Surface Mount Technology*, April 3-6, 1990, Atlantic City, NJ, USA. *Abstract Publisher*: IC Manage, 1990, Chicago, IL, USA.

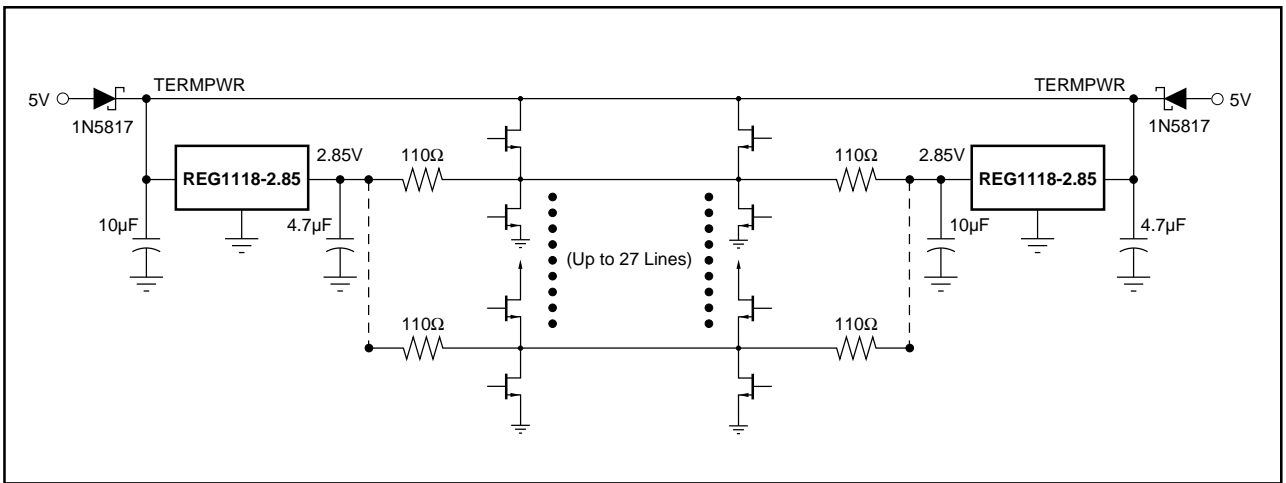

FIGURE 3. SCSI Active Termination Configuration.

The information provided herein is believed to be reliable; however, BURR-BROWN assumes no responsibility for inaccuracies or omissions. BURR-BROWN assumes no responsibility for the use of this information, and all use of such information shall be entirely at the user's own risk. Prices and specifications are subject to change without notice. No patent rights or licenses to any of the circuits described herein are implied or granted to any third party. BURR-BROWN does not authorize or warrant any BURR-BROWN product for use in life support devices and/or systems.

PACKAGING INFORMATION

Orderable Device	Status ⁽¹⁾	Package Type	Package Drawing	Pins	Package Qty	Eco Plan ⁽²⁾	Lead/Ball Finish	MSL Peak Temp ⁽³⁾
REG1118-2.85	ACTIVE	SOT-223	DCY	4	80	Green (RoHS & no Sb/Br)	CU NIPDAU	Level-1-260C-UNLIM
REG1118-2.85/2K5	ACTIVE	SOT-223	DCY	4	2500	Green (RoHS & no Sb/Br)	CU NIPDAU	Level-1-260C-UNLIM
REG1118-2.85/2K5G4	ACTIVE	SOT-223	DCY	4	2500	Green (RoHS & no Sb/Br)	CU NIPDAU	Level-1-260C-UNLIM
REG1118-2.85G4	ACTIVE	SOT-223	DCY	4	80	Green (RoHS & no Sb/Br)	CU NIPDAU	Level-1-260C-UNLIM

⁽¹⁾ The marketing status values are defined as follows:

ACTIVE: Product device recommended for new designs.

LIFEBUY: TI has announced that the device will be discontinued, and a lifetime-buy period is in effect.

NRND: Not recommended for new designs. Device is in production to support existing customers, but TI does not recommend using this part in a new design.

PREVIEW: Device has been announced but is not in production. Samples may or may not be available.

OBsolete: TI has discontinued the production of the device.

⁽²⁾ Eco Plan - The planned eco-friendly classification: Pb-Free (RoHS), Pb-Free (RoHS Exempt), or Green (RoHS & no Sb/Br) - please check <http://www.ti.com/productcontent> for the latest availability information and additional product content details.

TBD: The Pb-Free/Green conversion plan has not been defined.

Pb-Free (RoHS): TI's terms "Lead-Free" or "Pb-Free" mean semiconductor products that are compatible with the current RoHS requirements for all 6 substances, including the requirement that lead not exceed 0.1% by weight in homogeneous materials. Where designed to be soldered at high temperatures, TI Pb-Free products are suitable for use in specified lead-free processes.

Pb-Free (RoHS Exempt): This component has a RoHS exemption for either 1) lead-based flip-chip solder bumps used between the die and package, or 2) lead-based die adhesive used between the die and leadframe. The component is otherwise considered Pb-Free (RoHS compatible) as defined above.

Green (RoHS & no Sb/Br): TI defines "Green" to mean Pb-Free (RoHS compatible), and free of Bromine (Br) and Antimony (Sb) based flame retardants (Br or Sb do not exceed 0.1% by weight in homogeneous material)

⁽³⁾ MSL, Peak Temp. -- The Moisture Sensitivity Level rating according to the JEDEC industry standard classifications, and peak solder temperature.

Important Information and Disclaimer:The information provided on this page represents TI's knowledge and belief as of the date that it is provided. TI bases its knowledge and belief on information provided by third parties, and makes no representation or warranty as to the accuracy of such information. Efforts are underway to better integrate information from third parties. TI has taken and continues to take reasonable steps to provide representative and accurate information but may not have conducted destructive testing or chemical analysis on incoming materials and chemicals. TI and TI suppliers consider certain information to be proprietary, and thus CAS numbers and other limited information may not be available for release.

In no event shall TI's liability arising out of such information exceed the total purchase price of the TI part(s) at issue in this document sold by TI to Customer on an annual basis.

TAPE AND REEL BOX DIMENSIONS



*All dimensions are nominal

Device	Package Type	Package Drawing	Pins	SPQ	Length (mm)	Width (mm)	Height (mm)
REG1118-2.85/2K5	SOT-223	DCY	4	2500	358.0	335.0	35.0

IMPORTANT NOTICE

Texas Instruments Incorporated and its subsidiaries (TI) reserve the right to make corrections, modifications, enhancements, improvements, and other changes to its products and services at any time and to discontinue any product or service without notice. Customers should obtain the latest relevant information before placing orders and should verify that such information is current and complete. All products are sold subject to TI's terms and conditions of sale supplied at the time of order acknowledgment.

TI warrants performance of its hardware products to the specifications applicable at the time of sale in accordance with TI's standard warranty. Testing and other quality control techniques are used to the extent TI deems necessary to support this warranty. Except where mandated by government requirements, testing of all parameters of each product is not necessarily performed.

TI assumes no liability for applications assistance or customer product design. Customers are responsible for their products and applications using TI components. To minimize the risks associated with customer products and applications, customers should provide adequate design and operating safeguards.

TI does not warrant or represent that any license, either express or implied, is granted under any TI patent right, copyright, mask work right, or other TI intellectual property right relating to any combination, machine, or process in which TI products or services are used. Information published by TI regarding third-party products or services does not constitute a license from TI to use such products or services or a warranty or endorsement thereof. Use of such information may require a license from a third party under the patents or other intellectual property of the third party, or a license from TI under the patents or other intellectual property of TI.

Reproduction of TI information in TI data books or data sheets is permissible only if reproduction is without alteration and is accompanied by all associated warranties, conditions, limitations, and notices. Reproduction of this information with alteration is an unfair and deceptive business practice. TI is not responsible or liable for such altered documentation. Information of third parties may be subject to additional restrictions.

Resale of TI products or services with statements different from or beyond the parameters stated by TI for that product or service voids all express and any implied warranties for the associated TI product or service and is an unfair and deceptive business practice. TI is not responsible or liable for any such statements.

TI products are not authorized for use in safety-critical applications (such as life support) where a failure of the TI product would reasonably be expected to cause severe personal injury or death, unless officers of the parties have executed an agreement specifically governing such use. Buyers represent that they have all necessary expertise in the safety and regulatory ramifications of their applications, and acknowledge and agree that they are solely responsible for all legal, regulatory and safety-related requirements concerning their products and any use of TI products in such safety-critical applications, notwithstanding any applications-related information or support that may be provided by TI. Further, Buyers must fully indemnify TI and its representatives against any damages arising out of the use of TI products in such safety-critical applications.

TI products are neither designed nor intended for use in military/aerospace applications or environments unless the TI products are specifically designated by TI as military-grade or "enhanced plastic." Only products designated by TI as military-grade meet military specifications. Buyers acknowledge and agree that any such use of TI products which TI has not designated as military-grade is solely at the Buyer's risk, and that they are solely responsible for compliance with all legal and regulatory requirements in connection with such use.

TI products are neither designed nor intended for use in automotive applications or environments unless the specific TI products are designated by TI as compliant with ISO/TS 16949 requirements. Buyers acknowledge and agree that, if they use any non-designated products in automotive applications, TI will not be responsible for any failure to meet such requirements.

Following are URLs where you can obtain information on other Texas Instruments products and application solutions:

Products

Amplifiers	amplifier.ti.com
Data Converters	dataconverter.ti.com
DLP® Products	www.dlp.com
DSP	dsp.ti.com
Clocks and Timers	www.ti.com/clocks
Interface	interface.ti.com
Logic	logic.ti.com
Power Mgmt	power.ti.com
Microcontrollers	microcontroller.ti.com
RFID	www.ti-rfid.com
RF/IF and ZigBee® Solutions	www.ti.com/lprf

Applications

Audio	www.ti.com/audio
Automotive	www.ti.com/automotive
Broadband	www.ti.com/broadband
Digital Control	www.ti.com/digitalcontrol
Medical	www.ti.com/medical
Military	www.ti.com/military
Optical Networking	www.ti.com/opticalnetwork
Security	www.ti.com/security
Telephony	www.ti.com/telephony
Video & Imaging	www.ti.com/video
Wireless	www.ti.com/wireless

Mailing Address: Texas Instruments, Post Office Box 655303, Dallas, Texas 75265
Copyright © 2009, Texas Instruments Incorporated