

NMLU1210

Full Bridge Rectifier

Dual 20 V N-Channel with dual 3.2 A Schottky Barrier Diode, 4.0 x 4.0 x 0.5 mm μ Cool™ Package

Features

- Full-Bridge Rectifier Block
- Up to 3.2 A operation
- Low $R_{DS(on)}$ MOSFET to minimize conduction loss
- Low gate charge MOSFET
- Low VF Schottky diode
- Ultra Low Inductance Package
- This Device uses Halogen-Free Molding Compound
- These are Pb-Free Devices

Applications

- Wireless Charging
- AC-DC Rectification
- Optimized for Power Management Applications for Portable Products, such as Cell Phones, PMP, DSC, GPS, and others

RECTIFIER MAXIMUM RATINGS ($T_J = 25^\circ\text{C}$ unless otherwise stated)

Parameter	Symbol	Value	Unit	
Input voltage between two MOSFET drain	V_{LL}	20	V	
Bridge Operating Junction and Storage Temperature	T_J, T_{STG}	-55 to 125	$^\circ\text{C}$	
Lead Temperature for Soldering Purposes (1/8" from case for 10 s)	T_L	260	$^\circ\text{C}$	
Continuous Drain Current R_{JA} (Note 1)	I_O	$T_A = 25^\circ\text{C}$	2.2	A
		$T_A = 85^\circ\text{C}$	1.16	
Power Dissipation R_{JA} (Note 1)	P_D	$T_A = 25^\circ\text{C}$	1.2	W
		$T_A = 85^\circ\text{C}$	0.47	
Continuous Drain Current $R_{JA} t < 5$ s (Note 1)	I_O	$T_A = 25^\circ\text{C}$	3.2	A
		$T_A = 85^\circ\text{C}$	1.88	
Power Dissipation $R_{JA} t < 5$ s (Note 1)	P_D	$T_A = 25^\circ\text{C}$	2.34	W
		$T_A = 85^\circ\text{C}$	0.94	
Continuous Drain Current R_{JA} (Note 2)	I_O	$T_A = 25^\circ\text{C}$	1.16	A
		$T_A = 85^\circ\text{C}$	0.6	
Power Dissipation R_{JA} (Note 2)	P_D	$T_A = 25^\circ\text{C}$	0.47	W
		$T_A = 85^\circ\text{C}$	0.185	

Stresses exceeding Maximum Ratings may damage the device. Maximum Ratings are stress ratings only. Functional operation above the Recommended Operating Conditions is not implied. Extended exposure to stresses above the Recommended Operating Conditions may affect device reliability.

1. Surface-mounted on FR4 board using 1 in sq pad size (Cu area = 1.127 in sq [2 oz] including traces).
2. Surface-mounted on FR4 board using the minimum recommended pad size of 30 mm², 2 oz. Cu.



ON Semiconductor®

<http://onsemi.com>

MOSFET

$V_{(BR)DSS}$	$R_{DS(on)}$ TYP	I_D MAX
20 V	23 m Ω @ 4.5 V	3.2 A
	17 m Ω @ 10 V	

SCHOTTKY DIODE

V_R MAX	V_F TYP	I_F MAX
20 V	0.45 V	3.2 A

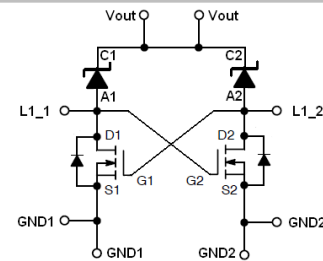

RECTIFIER

4.0 4.0 mm μ Cool Pin Connections (Top View)

MARKING DIAGRAM



**UDFN
CASE 517BS**

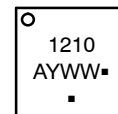

1210 = Specific Device Code
 A = Assembly Location
 Y = Year
 WW = Work Week
 ■ = Pb-Free Package

(*Note: Microdot may be in either location)

PIN CONNECTIONS

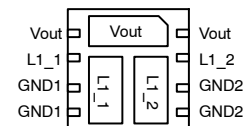

(Top View)

ORDERING INFORMATION

Device	Package	Shipping†
NMLU1210TWG	UDFN (Pb-Free)	3000 / Tape & Reel

†For information on tape and reel specifications, including part orientation and tape sizes, please refer to our Tape and Reel Packaging Specifications Brochure, BRD8011/D.

NMLU1210

THERMAL RESISTANCE RATINGS

Parameter	Symbol	Max	Unit
Junction-to-Ambient – Steady State (Note 3)	$R_{\theta JA}$	82.5	°C/W
Junction-to-Ambient – $t \leq 5$ s (Note 3)	$R_{\theta JA}$	42.5	
Junction-to-Ambient – Steady State min Pad (Note 4)	$R_{\theta JA}$	209	

3. Surface-mounted on FR4 board using 1 in sq pad size (Cu area = 1.127 in sq [2 oz] including traces).
 4. Surface-mounted on FR4 board using the minimum recommended pad size of 30 mm², 2 oz. Cu.

BRIDGE ELECTRICAL CHARACTERISTICS ($T_J = 25^\circ\text{C}$ unless otherwise specified)

Parameter	Symbol	Test Condition	Min	Typ	Max	Unit
ON CHARACTERISTICS						
Rectifying Forward Voltage (Note 5)	V_{fd2}	Input voltage $V_{LL} = \pm 5$ V; The output current of Rectifier $I_{out} = 2$ A		0.45	.56	V
Rectifier leakage current	I_{leak}	Input voltage $V_{LL} = 16$ V; No Load on the Rectifier output		31	1000	uA
Rectifier Reverse leakage current	I_{rleak}	Input voltage $V_{LL} = 0$ V; The output voltage of the Rectifier $V_{out} = 5$ V		21	1000	uA

5. Pulse Test: pulse width ≤ 300 μs , duty cycle $\leq 2\%$

MOSFET ELECTRICAL CHARACTERISTICS ($T_J = 25^\circ\text{C}$ unless otherwise specified)

Parameter	Symbol	Test Condition	Min	Typ	Max	Unit
ON CHARACTERISTICS						
Gate Threshold Voltage	$V_{GS(TH)}$	$V_{GS} = V_{DS}$, $I_D = 250$ μA	1.2		2.2	V
Negative Threshold Temperature Coefficient	$V_{GS(TH)} / T_J$			4		mV/°C
Drain-to-Source On Resistance (Note 6)	$R_{DS(on)}$	$V_{GS} = 10$ V, $I_D = 3.2$ A		17	26	m Ω
		$V_{GS} = 4.5$ V, $I_D = 3.2$ A		23	32	
Forward Transconductance	g_{FS}	$V_{DS} = 10$ V, $I_D = 2.0$ A		3.5		S

DRAIN-SOURCE DIODE CHARACTERISTICS

Forward Diode Voltage (Note 6)	V_{SD}	$V_{GS} = 0$ V, $I_S = 2.0$ A	$T_J = 25^\circ\text{C}$		0.79		V
			$T_J = 125^\circ\text{C}$		0.65		

6. Pulse Test: pulse width ≤ 300 μs , duty cycle $\leq 2\%$

SCHOTTKY DIODE ELECTRICAL CHARACTERISTICS ($T_J = 25^\circ\text{C}$ unless otherwise specified)

Parameter	Symbol	Test Condition	Min	Typ	Max	Unit
Maximum Instantaneous Forward Voltage (Note 7)	V_F	$I_F = 1.0$ A		0.36		V
		$I_F = 2.0$ A		0.41		
Maximum Instantaneous Reverse Current	I_R	$V_R = 20$ V		0.04		mA

7. Pulse Test: pulse width ≤ 300 μs , duty cycle $\leq 2\%$

SCHOTTKY DIODE ELECTRICAL CHARACTERISTICS ($T_J = 100^\circ\text{C}$ unless otherwise specified)

Parameter	Symbol	Test Condition	Min	Typ	Max	Unit
Maximum Instantaneous Forward Voltage (Note 8)	V_F	$I_F = 1.0$ A		0.29		V
		$I_F = 2.0$ A		0.36		
Maximum Instantaneous Reverse Current	I_R	$V_R = 20$ V		4		mA

8. Pulse Test: pulse width ≤ 300 μs , duty cycle $\leq 2\%$
 9. For detailed MOSFET and Diode parameters, please refer to the ON Semiconductor datasheets of NTTFS4930N and MBR230LSFT1G. The test on each individual die is limited to the system package.

NMLU1210

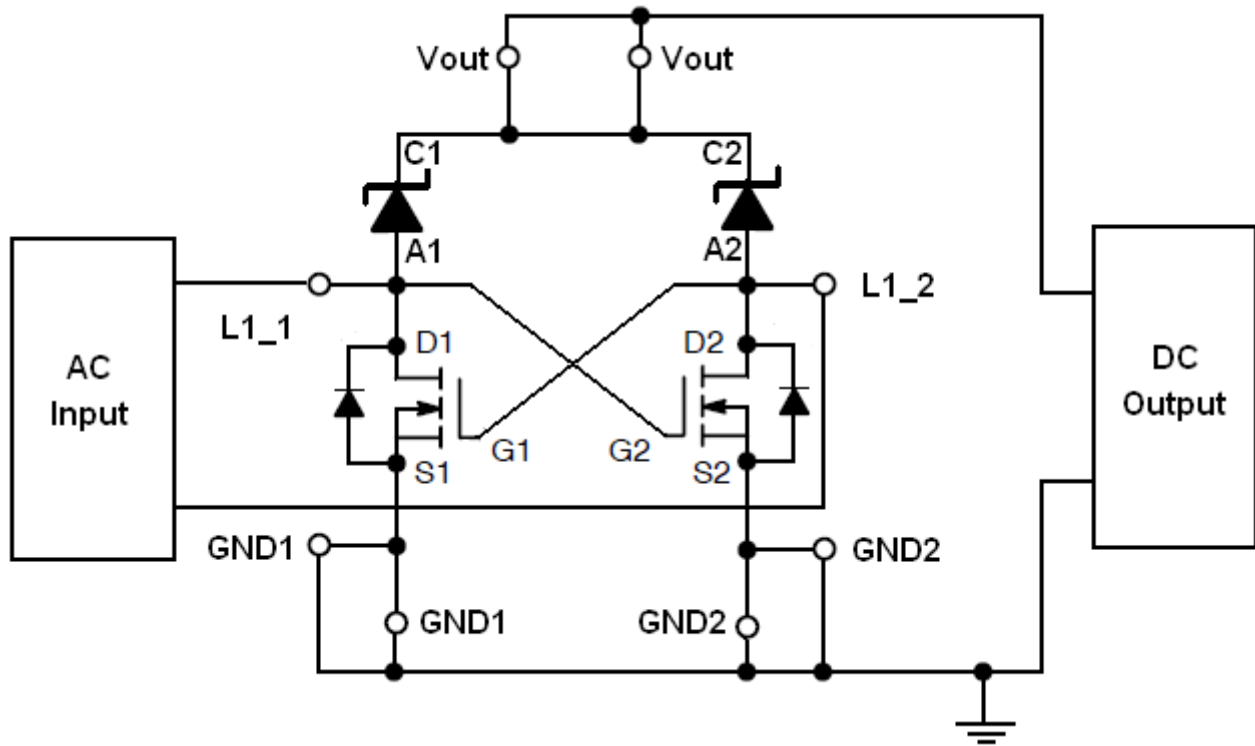

Figure 1. Typical Application Circuit

GND1 and GND2 are not internally connected. The user should make the connection in the PCB design.

NMLU1210

TYPICAL PERFORMANCE CURVES

($T_J = 25^\circ\text{C}$ unless otherwise specified)

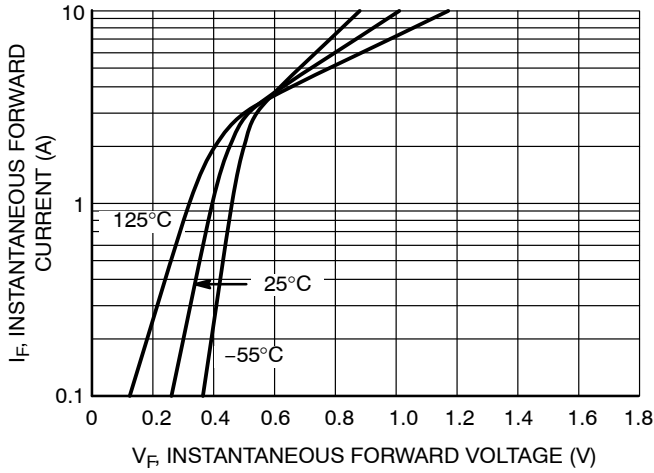

Figure 2. Bridge Typical Forward Voltage Drop at $V_{in} \geq 5\text{ V}$

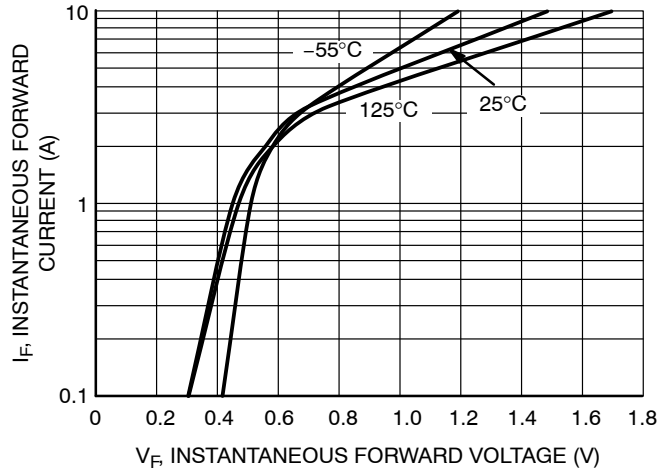

Figure 3. Bridge Maximum Forward Voltage Drop at $V_{in} \geq 5\text{ V}$

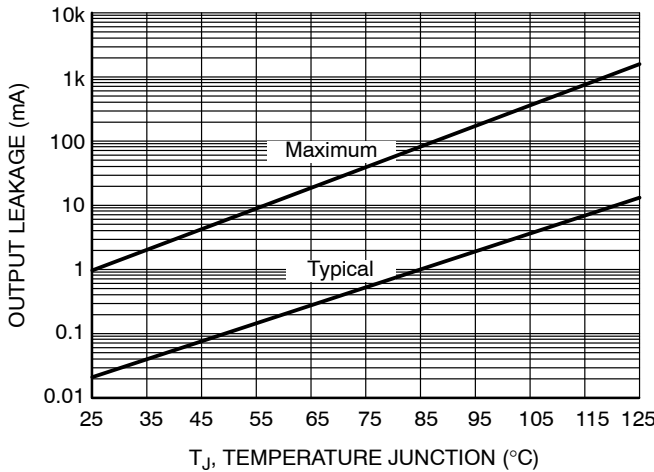

Figure 4. Output Leakage at 5 V Bias vs. Junction Temperature

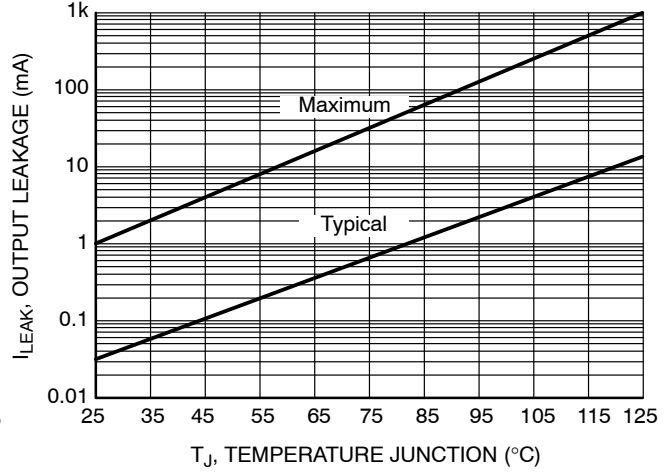

Figure 5. Input Leakage at 16 V vs. Junction Temperature

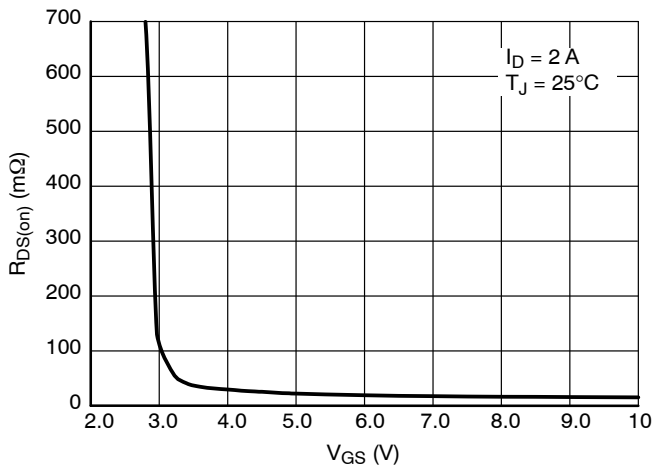

Figure 6. FET Typical On-Resistance vs. Gate-to-Source Voltage (from 3 V to 10 V)

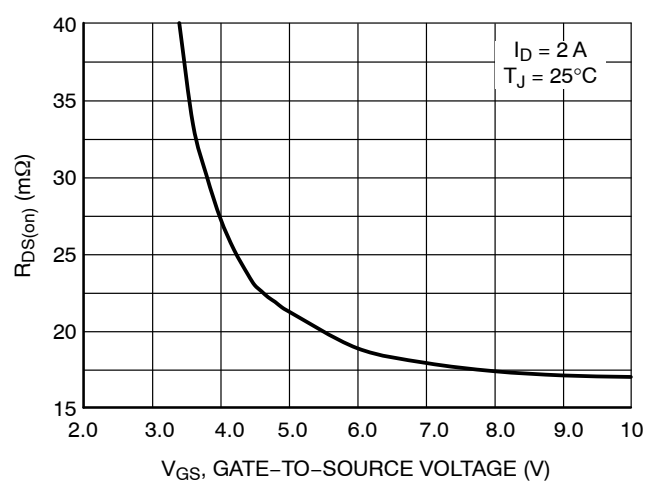

Figure 7. FET Typical On-Resistance vs. Gate-to-Source Voltage

TYPICAL PERFORMANCE CURVES

($T_J = 25^\circ\text{C}$ unless otherwise specified)

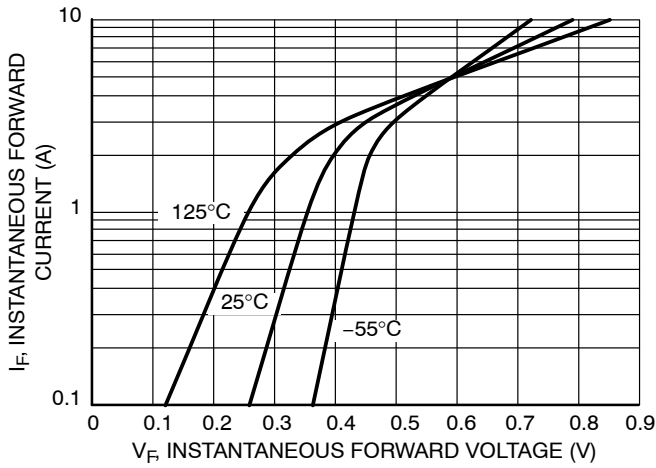

Figure 8. Schottky Typical Forward Current vs. Forward Voltage

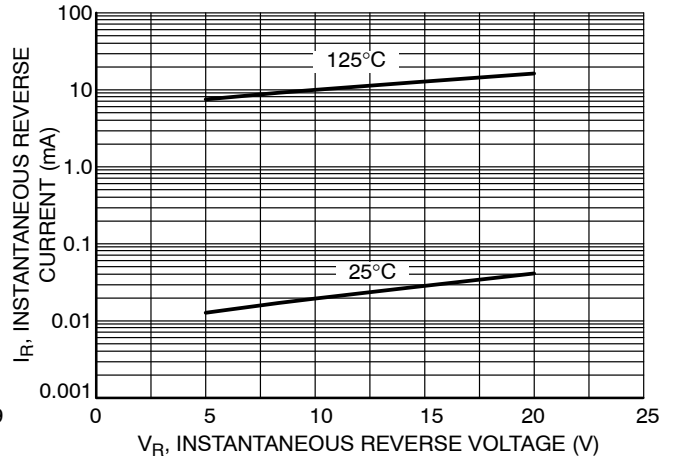
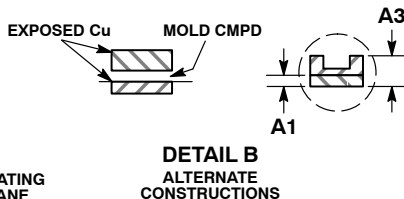
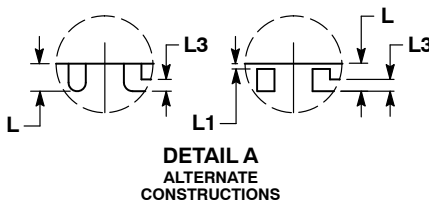
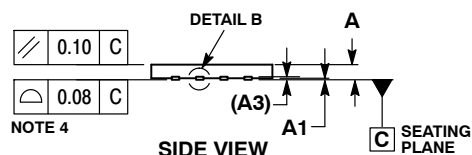
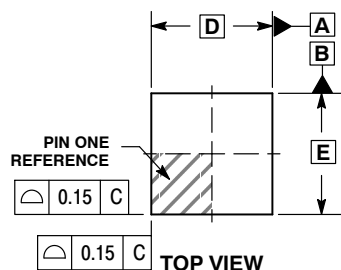

Figure 9. Schottky Typical Reverse Current vs. Reverse Voltage

NMLU1210

PACKAGE DIMENSIONS

UDFN8 4x4, 0.8P CASE 517BS ISSUE A



NOTES:

1. DIMENSIONING AND TOLERANCING PER ASME Y14.5M, 1994.
2. CONTROLLING DIMENSION: MILLIMETERS.
3. DIMENSION b APPLIES TO PLATED TERMINAL AND IS MEASURED BETWEEN 0.15 AND 0.25MM FROM TERMINAL TIP.
4. COPLANARITY APPLIES TO THE EXPOSED PAD AS WELL AS THE TERMINALS.
5. POSITIONAL TOLERANCE APPLIES TO ALL OF THE EXPOSED PADS.

MILLIMETERS		
DIM	MIN	MAX
A	0.45	0.55
A1	0.00	0.05
A3	0.13 REF	
b	0.20	0.30
D	4.00 BSC	
D2	2.10	2.30
D3	0.90	1.10
E	4.00 BSC	
E2	2.50	2.70
E3	1.00	1.20
e	0.80 BSC	
F	3.55 BSC	
L	0.30	0.50
L1	0.00	0.15
L3	0.13	0.23

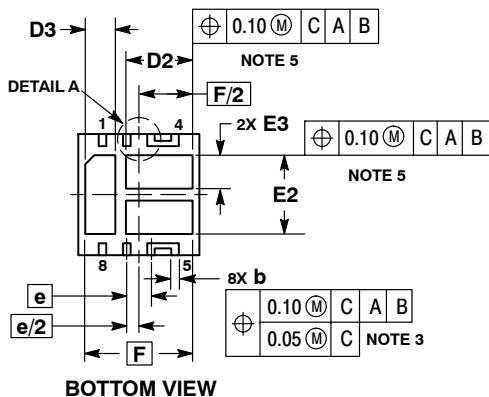

RECOMMENDED SOLDERING FOOTPRINT*

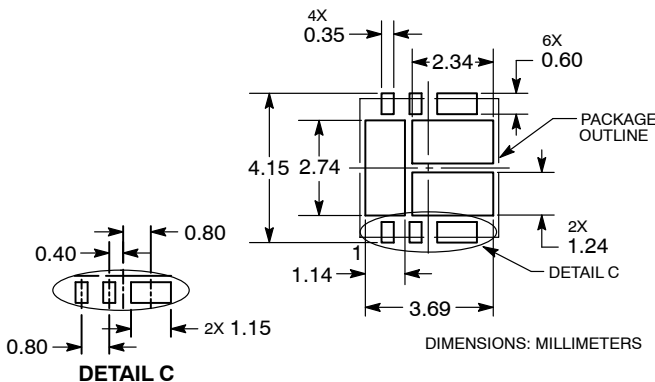

*For additional information on our Pb-Free strategy and soldering details, please download the ON Semiconductor Soldering and Mounting Techniques Reference Manual, SOLDERRM/D.

µCool is a trademark of Semiconductor Components Industries, LLC (SCILLC).

ON Semiconductor and are registered trademarks of Semiconductor Components Industries, LLC (SCILLC). SCILLC reserves the right to make changes without further notice to any products herein. SCILLC makes no warranty, representation or guarantee regarding the suitability of its products for any particular purpose, nor does SCILLC assume any liability arising out of the application or use of any product or circuit, and specifically disclaims any and all liability, including without limitation special, consequential or incidental damages. "Typical" parameters which may be provided in SCILLC data sheets and/or specifications can and do vary in different applications and actual performance may vary over time. All operating parameters, including "Typicals" must be validated for each customer application by customer's technical experts. SCILLC does not convey any license under its patent rights nor the rights of others. SCILLC products are not designed, intended, or authorized for use as components in systems intended for surgical implant into the body, or other applications intended to support or sustain life, or for any other application in which the failure of the SCILLC product could create a situation where personal injury or death may occur. Should Buyer purchase or use SCILLC products for any such unintended or unauthorized application, Buyer shall indemnify and hold SCILLC and its officers, employees, subsidiaries, affiliates, and distributors harmless against all claims, costs, damages, and expenses, and reasonable attorney fees arising out of, directly or indirectly, any claim of personal injury or death associated with such unintended or unauthorized use, even if such claim alleges that SCILLC was negligent regarding the design or manufacture of the part. SCILLC is an Equal Opportunity/Affirmative Action Employer. This literature is subject to all applicable copyright laws and is not for resale in any manner.

PUBLICATION ORDERING INFORMATION

LITERATURE FULFILLMENT:
Literature Distribution Center for ON Semiconductor
P.O. Box 5163, Denver, Colorado 80217 USA
Phone: 303-675-2175 or 800-344-3860 Toll Free USA/Canada
Fax: 303-675-2176 or 800-344-3867 Toll Free USA/Canada
Email: orderlit@onsemi.com

N. American Technical Support: 800-282-9855 Toll Free
USA/Canada
Europe, Middle East and Africa Technical Support:
Phone: 421 33 790 2910
Japan Customer Focus Center
Phone: 81-3-5817-1050

ON Semiconductor Website: www.onsemi.com
Order Literature: <http://www.onsemi.com/orderlit>

For additional information, please contact your local Sales Representative