

# NCP81253

## 5 V MOSFET Driver Compatible with Single-Phase IMVP8 Controllers

The NCP81253 is a high performance dual MOSFET gate driver in a small 2 mm x 2 mm package, optimized to drive the gates of both high-side and low-side power MOSFETs in a synchronous buck converter. The driver outputs can be placed into a high-impedance state via the tri-state PWM and EN inputs. The NCP81253 comes packaged with an integrated boost diode to minimize external components. A VCC UVLO function guarantees the outputs are low when the supply voltage is low.

### Features

- Space-efficient 2 mm x 2 mm DFN8 Thermally-enhanced Package
- VCC Range of 4.5 V to 5.5 V
- Internal Bootstrap Diode
- 5 V 3-stage PWM Input
- Diode Braking Capability via EN Mid-state
- Adaptive Anti-cross Conduction Circuit Protects against Cross-conduction during FET Turn-on and Turn-off
- Output Disable Control Turns Off both MOSFETs via Enable Pin
- VCC Undervoltage Lockout
- These devices are Pb-free, Halogen-free/BFR-free and are RoHS compliant

### Typical Applications

- Power Solutions for Notebook and Desktop Systems



ON Semiconductor®

[www.onsemi.com](http://www.onsemi.com)



DFN8  
CASE 506AA

### MARKING DIAGRAM



CG = Specific Device Code

M = Date Code

▪ = Pb-Free Package

(Note: Microdot may be in either location)

### PINOUT DIAGRAM

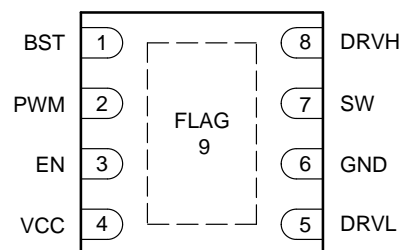

(Top View)

### ORDERING INFORMATION

Device	Package	Shipping†
NCP81253MNTBG	DFN8 (Pb-Free)	3000 / Tape & Reel

†For information on tape and reel specifications, including part orientation and tape sizes, please refer to our Tape and Reel Packaging Specifications Brochure, BRD8011/D.

# NCP81253

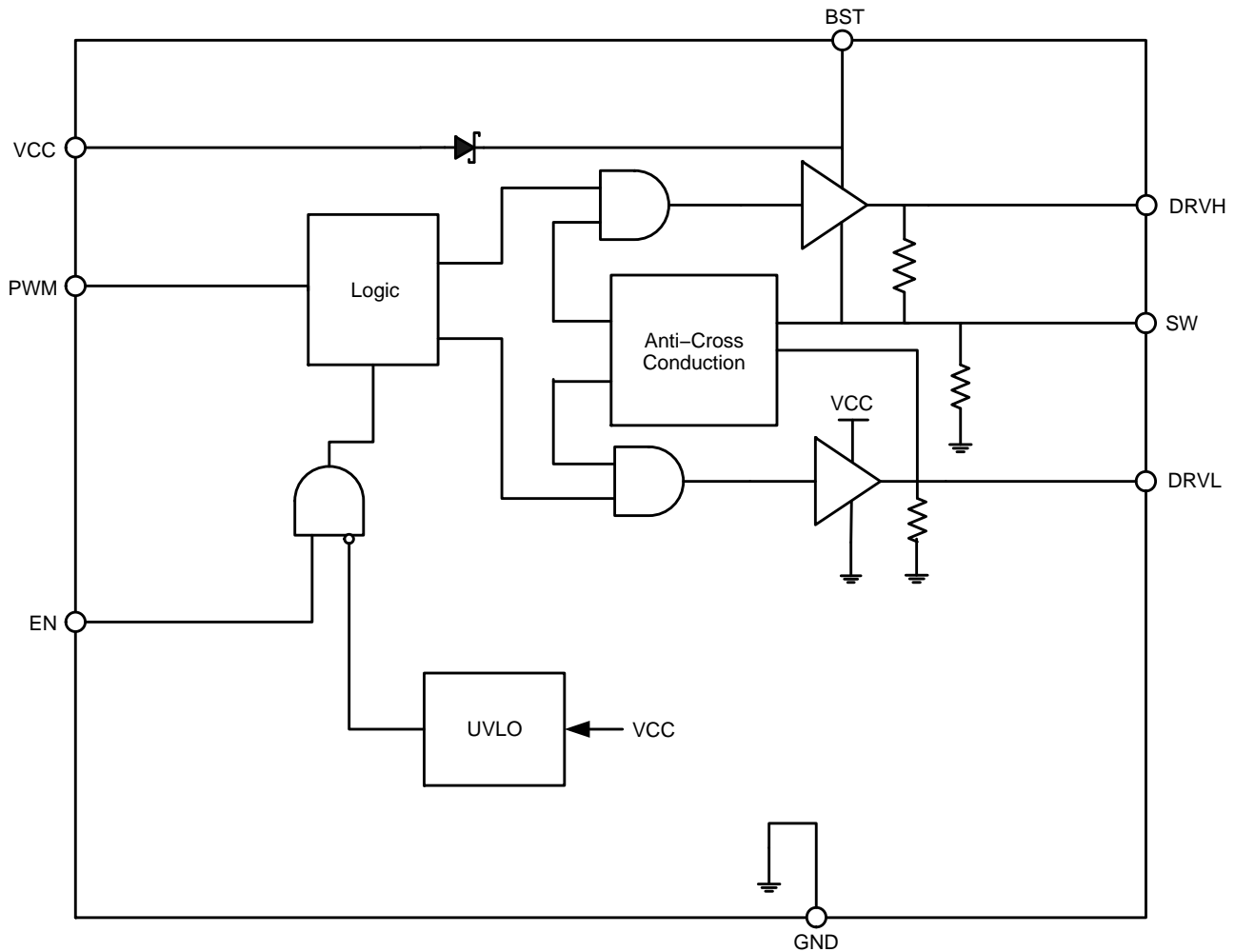

**Figure 1. Block Diagram**

**Table 1. PIN FUNCTION DESCRIPTION**

Pin No.	Pin Name	Description
1	BST	Floating bootstrap supply pin for the high-side gate driver. Connect the external bootstrap capacitor between this pin and SW.
2	PWM	Control input: PWM = High → DRVH is high, DRVL is low. PWM = Mid → DRVH and DRVL are low. PWM = Low → DRVH is low, DRVL is high.
3	EN	3-state input: EN = High → Driver is enabled; normal PWM operation. EN = Mid → Driver is enabled; DRVH and DRVL are low (body diode braking). EN = Low → Driver is disabled.
4	VCC	Power supply input. Connect a bypass capacitor from this pin to ground.
5	DRVL	Low-side gate drive output. Connect to the gate of the low-side MOSFET.
6	GND	Bias and reference ground. All signals are referenced to this node.
7	SW	Switch node. Connect this pin to the source of the high-side MOSFET and drain of the low-side MOSFET.
8	DRVH	High-side gate drive output. Connect to the gate of the high-side MOSFET.
9	FLAG	Thermal flag. There is no electrical connection to the IC. Connect to the ground plane.

# NCP81253

**Table 2. ABSOLUTE MAXIMUM RATINGS**

Rating	Symbol	Min	Max
Main Supply Voltage (Note 1)	V <sub>CC</sub>	-0.3 V	6.5 V
Bootstrap Supply Voltage	BST	-0.3 V wrt/SW	35 V wrt/GND 40 V (≤ 50 ns) wrt/GND 6.5 V wrt/SW
Switch Node Voltage	SW	-5 V -10 V (≤ 200 ns)	35 V 40 V (≤ 50 ns)
High-Side Driver Output	DRVH	-0.3 V wrt/SW -2 V (≤ 200 ns) wrt/SW	BST + 0.3 V wrt/SW
Low-Side Driver Output	DRVL	-0.3 V -5 V (≤ 200 ns)	V <sub>CC</sub> + 0.3 V
DRVH/DRVL Control Input, Enable Pin	PWM, EN	-0.3 V	6.5 V
Ground	GND	0 V	0 V
Storage Temperature Range	TSTG	-55°C	150°C
Operating Junction Temperature Range	T <sub>J</sub>	-40°C	150°C
Moisture Sensitivity Level	MSL		1

Stresses exceeding those listed in the Maximum Ratings table may damage the device. If any of these limits are exceeded, device functionality should not be assumed, damage may occur and reliability may be affected.

1. Refer to ELECTRICAL CHARACTERISTICS and APPLICATION INFORMATION for Safe Operating Area.

**Table 3. THERMAL CHARACTERISTICS**

Rating	Symbol	Value	Unit
Thermal Characteristics, DFN8, 2x2 mm (Note 2) Thermal Resistance, Junction-to-Air	R <sub>θJA</sub>	119	°C/W

2. Values based on copper area of 645 mm<sup>2</sup> (or 1 in<sup>2</sup>) of 1 oz copper thickness and FR4 PCB substrate.

**Table 4. OPERATING RANGES** (Note 3)

Rating	Symbol	Min	Max	Unit
Input Voltage	V <sub>CC</sub>	4.5	5.5	V
Ambient Temperature	T <sub>A</sub>	-40	100	°C

Functional operation above the stresses listed in the Recommended Operating Ranges is not implied. Extended exposure to stresses beyond the Recommended Operating Ranges limits may affect device reliability.

3. Refer to ELECTRICAL CHARACTERISTICS and APPLICATION INFORMATION for Safe Operating Area.

**Table 5. ELECTRICAL CHARACTERISTICS** V<sub>CC</sub> = 4.5 V to 5.5 V, V<sub>BST-SWN</sub> = 4.5 V to 5.5 V, BST = 4.5 V to 30 V, SW = 0 V to 21 V; for typical values T<sub>A</sub> = 25°C, for min/max values T<sub>A</sub> = -40°C to 100°C; unless otherwise noted. (Notes 4, 5)

Parameter	Test Conditions	Symbol	Min	Typ	Max	Unit
<b>SUPPLY VOLTAGE</b>						
V <sub>CC</sub> Operation Voltage		V <sub>CC</sub>	4.5		5.5	V
<b>UNDERVOLTAGE LOCKOUT</b>						
V <sub>CC</sub> Start Threshold	V <sub>CC</sub> rising	V <sub>UVLO</sub>	3.8	4.35	4.5	V
V <sub>CC</sub> UVLO Hysteresis		V <sub>UVLO_HYS</sub>	150	200	250	mV
<b>SUPPLY CURRENT</b>						
Shutdown Mode	ICC + IBST, EN = GND	I <sub>shutdown</sub>		1	20	μA
Normal Mode	ICC + IBST, EN = 5 V, PWM = 400 kHz No load on driver outputs.	I <sub>normal</sub>		1.6		mA
Standby Current 1	ICC + IBST, EN = 5 V, PWM = 0 V	I <sub>standby</sub>		0.9		mA

4. Refer to ABSOLUTE MAXIMUM RATINGS and APPLICATION INFORMATION for Safe Operating Area.

5. Performance guaranteed over the indicated operating temperature range by design and/or characterization tested at T<sub>J</sub> = T<sub>A</sub> = 25°C. Low duty cycle pulse techniques are used during testing to maintain the junction temperature as close to ambient as possible.

# NCP81253

**Table 5. ELECTRICAL CHARACTERISTICS** VCC = 4.5 V to 5.5 V, VBST–SWN = 4.5 V to 5.5 V, BST = 4.5 V to 30 V, SW = 0 V to 21 V; for typical values T<sub>A</sub> = 25°C, for min/max values T<sub>A</sub> = –40°C to 100°C; unless otherwise noted. (Notes 4, 5)

Parameter	Test Conditions	Symbol	Min	Typ	Max	Unit
-----------	-----------------	--------	-----	-----	-----	------

## BOOTSTRAP DIODE

Forward Voltage	VCC = 5 V, Forward bias current = 2 mA		0.1	0.4	0.6	V
-----------------	--	--	-----	-----	-----	---

## PWM INPUT

PWM Input High		PWM <sub>HI</sub>	3.4			V
PWM Mid-State		PWM <sub>MID</sub>	1.3		2.7	V
PWM Input Low		PWM <sub>LO</sub>			0.7	V

## HIGH-SIDE DRIVER

Output Impedance, Sourcing Current	VBST – VSW = 5 V			0.9	1.7	Ω
Output Impedance, Sinking Current	VBST – VSW = 5 V			0.7	1.7	Ω
DRVH Rise Time	VCC = 5 V, C <sub>load</sub> = 3 nF, VBST–VSW = 5 V, DRVH–SW = 90% to 10%	tr <sub>DRVH</sub>		16	25	ns
DRVH Fall Time	VCC = 5 V, C <sub>load</sub> = 3 nF, VBST–VSW = 5 V, DRVH–SW = 90% to 10%	tf <sub>DRVH</sub>		11	18	ns
DRVH Turn-Off Propagation Delay	C <sub>load</sub> = 3 nF, PWM = PWM <sub>LO</sub> to DRVH = 90%	tpd <sub>DRVH</sub>	10	18	30	ns
DRVH Turn-On Propagation Delay	C <sub>load</sub> = 3 nF, DRVH–SW = 1 V to DRVH–SW = 10%	tpdh <sub>DRVH</sub>	10	15	40	ns
SW Pull-down Resistance	SW to GND			45		kΩ
DRVH Pull-down Resistance	DRVH to SW			45		kΩ

## LOW-SIDE DRIVER

Output Impedance, Sourcing Current	VCC = 5 V			0.9	1.7	Ω
Output Impedance, Sinking Current	VCC = 5 V			0.4	0.8	Ω
DRVL Rise Time	VCC = 5 V, C <sub>load</sub> = 3 nF, VBST–VSW = 5 V, DRVL = 90% to 10%	tr <sub>DRVL</sub>		11	25	ns
DRVL Fall Time	VCC = 5 V, C <sub>load</sub> = 3 nF, VBST–VSW = 5 V, DRVL = 90% to 10%	tf <sub>DRVL</sub>		8	15	ns
DRVL Turn-Off Propagation Delay	C <sub>load</sub> = 3 nF, PWM = PWM <sub>HI</sub> to DRVL = 90%	tpd <sub>DRVL</sub>	10	15	30	ns
DRVL Turn-On Propagation Delay	C <sub>load</sub> = 3 nF, DRVH–SW = 1 V to DRVL = 10%	tpdh <sub>DRVL</sub>	5	8	25	ns
DRVL Pull-down Resistance	DRVL to GND, VCC = GND			45		kΩ

## EN INPUT

Enable Voltage High		EN <sub>HI</sub>	3.3			V
Enable Voltage Mid		EN <sub>MID</sub>	1.35		1.8	V
Enable Voltage Low		EN <sub>LO</sub>			0.6	V
Input Bias Current			–1.0		1.0	μA
EN High Propagation Delay Time	PWM = 0 V, EN going from 0 V to EN <sub>HI</sub> to DRVL rising to 10%	tpd <sub>EN_HI</sub>		20	40	ns

## SWITCH NODE

SW Node Leakage Current					20	μA
-------------------------	--	--	--	--	----	----

4. Refer to ABSOLUTE MAXIMUM RATINGS and APPLICATION INFORMATION for Safe Operating Area.
5. Performance guaranteed over the indicated operating temperature range by design and/or characterization tested at T<sub>J</sub> = T<sub>A</sub> = 25°C. Low duty cycle pulse techniques are used during testing to maintain the junction temperature as close to ambient as possible.

Product parametric performance is indicated in the Electrical Characteristics for the listed test conditions, unless otherwise noted. Product performance may not be indicated by the Electrical Characteristics if operated under different conditions.

TYPICAL CHARACTERISTICS

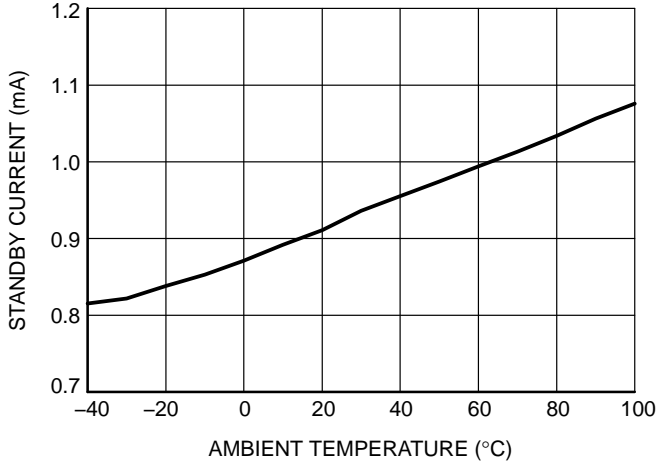

Figure 2. Standby Current vs. Temperature ( $V_{CC} = 5\text{ V}$ ,  $EN = 5\text{ V}$ ,  $PWM = 0\text{ V}$ )

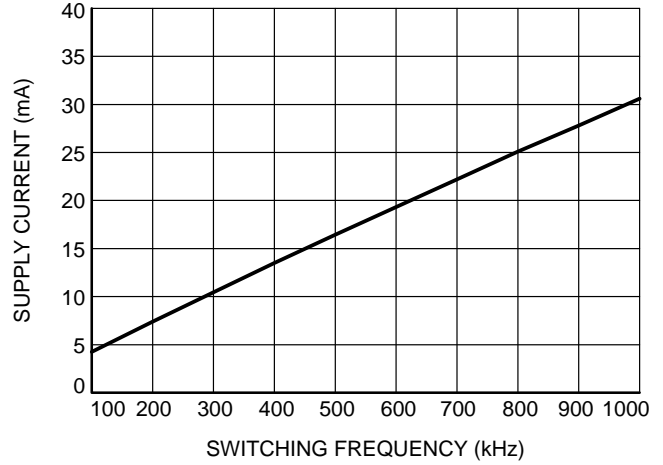

Figure 3. Supply Current vs. Switching Frequency ( $V_{CC} = 5\text{ V}$ ,  $C_{load} = 3\text{ nF}$ )

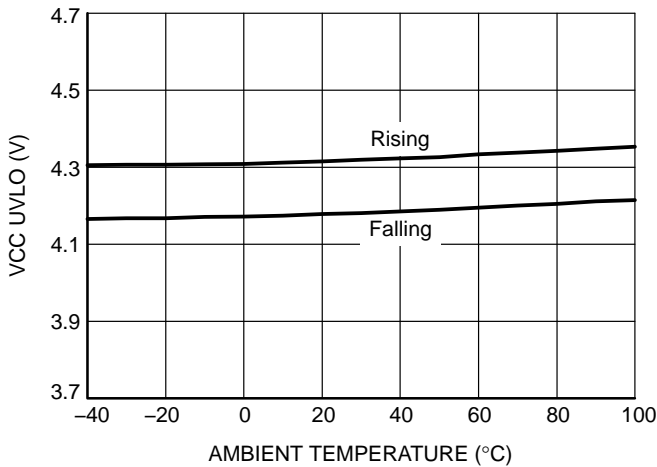

Figure 4.  $V_{CC}$  UVLO vs. Temperature ( $EN = 5\text{ V}$ )

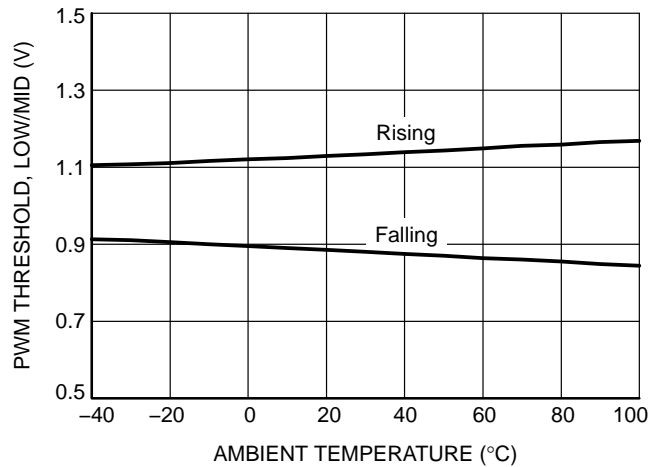

Figure 5. PWM Low/Mid Thresholds vs. Temperature ( $V_{CC} = 5\text{ V}$ )

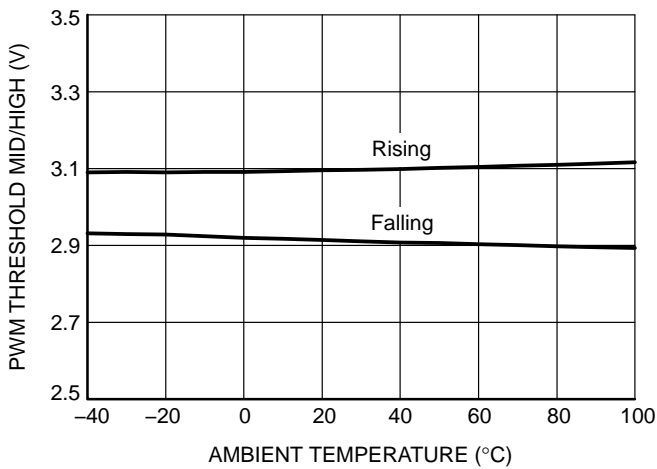

Figure 6. PWM Mid/High Thresholds vs. Temperature ( $V_{CC} = 5\text{ V}$ )

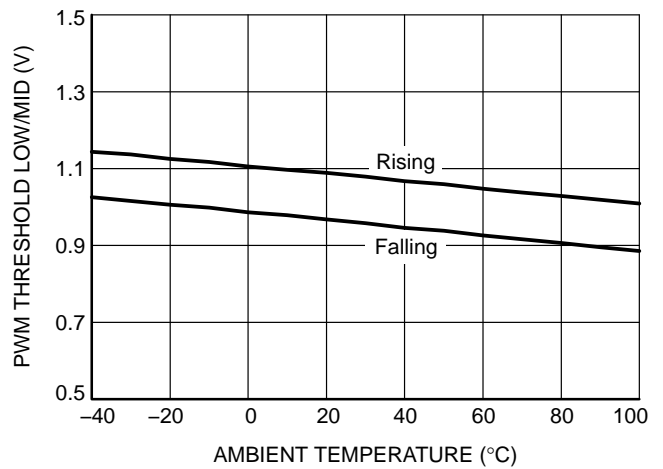

Figure 7. Enable Low/Mid Thresholds vs. Temperature ( $V_{CC} = 5\text{ V}$ )

TYPICAL CHARACTERISTICS

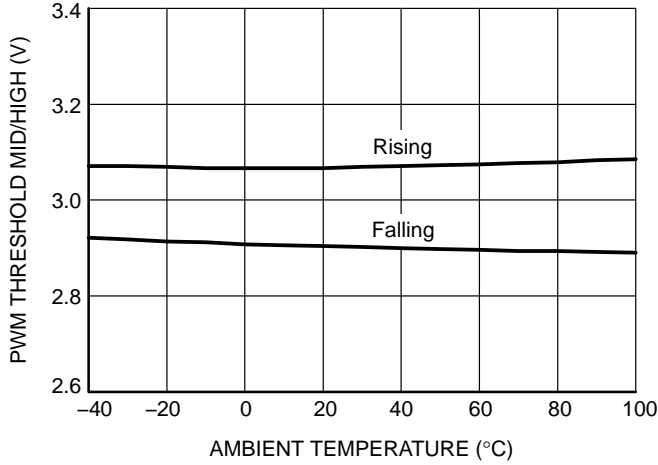

Figure 8. Enable Mid/High Thresholds vs. Temperature ( $V_{CC} = 5\text{ V}$ )

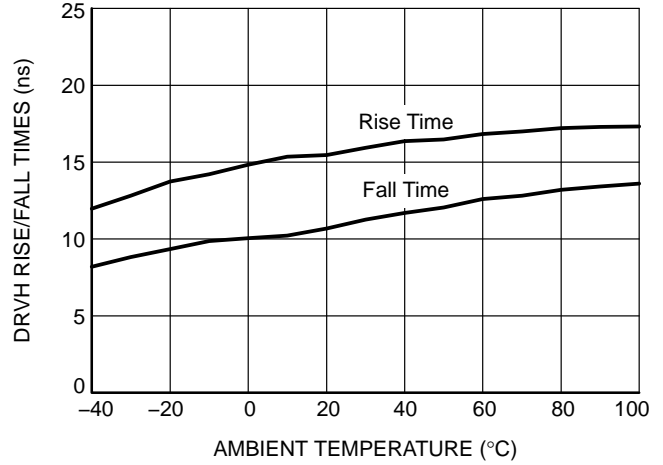

Figure 9. DRVH Rise/Fall Times vs. Temperature ( $V_{BST} - V_{SW} = 5\text{ V}$ ,  $C_{load} = 3\text{ nF}$ )

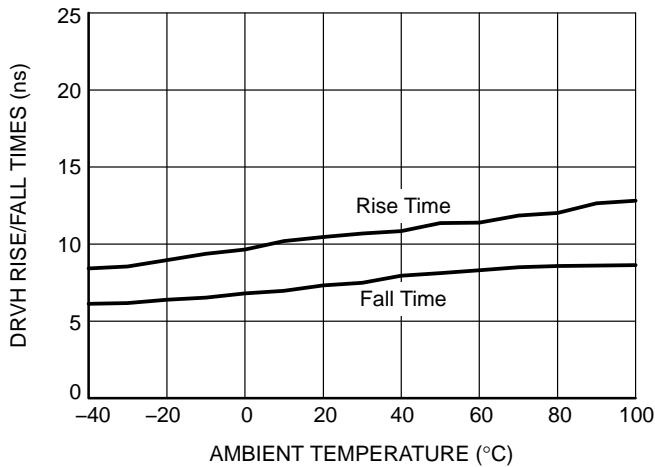

Figure 10. DRVH Rise/Fall Times vs. Temperature ( $V_{CC} = 5\text{ V}$ ,  $C_{load} = 3\text{ nF}$ )

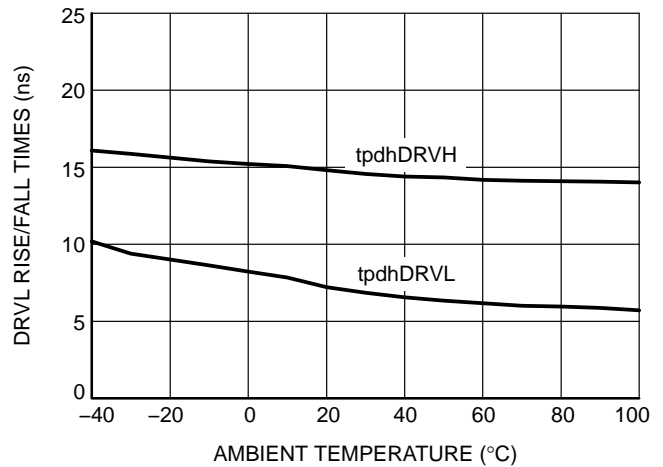

Figure 11. Dead Times vs. Temperature ( $V_{CC} = 5\text{ V}$ ,  $C_{load} = 3\text{ nF}$ )

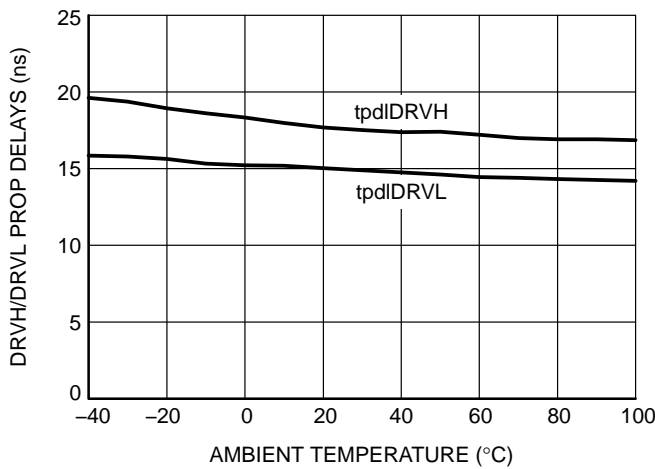

Figure 12. DRVH/DRVH Prop Delays vs. Temperature ( $V_{CC} = 5\text{ V}$ ,  $C_{load} = 3\text{ nF}$ )

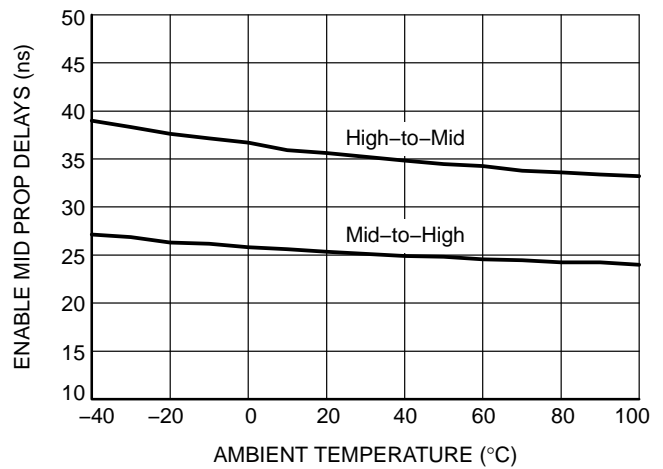

Figure 13. Enable Mid Prop Delays vs. Temperature ( $V_{CC} = 5\text{ V}$ ,  $C_{load} = 3\text{ nF}$ )

# NCP81253

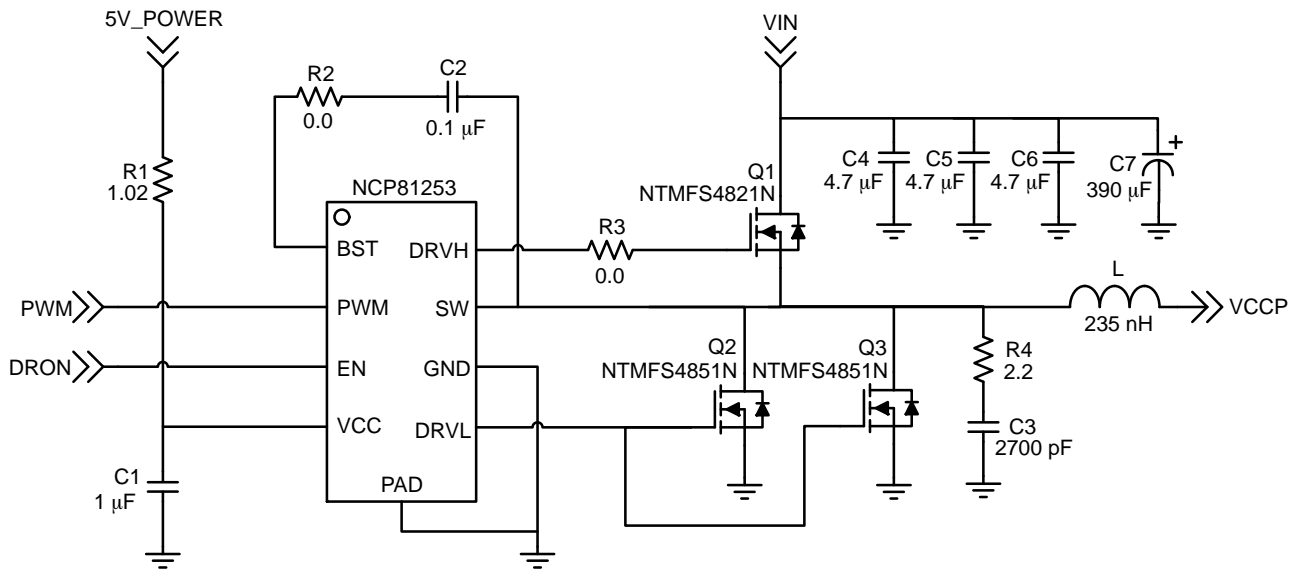

Figure 14. Application Circuit

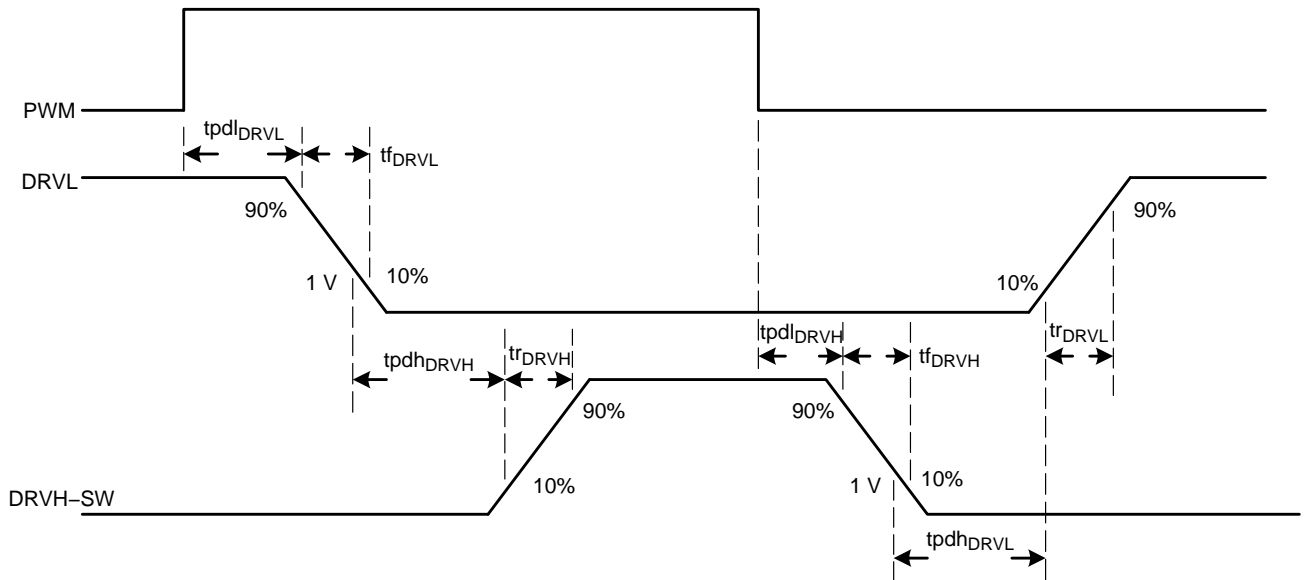

Figure 15. Gate Timing Diagram

## NCP81253

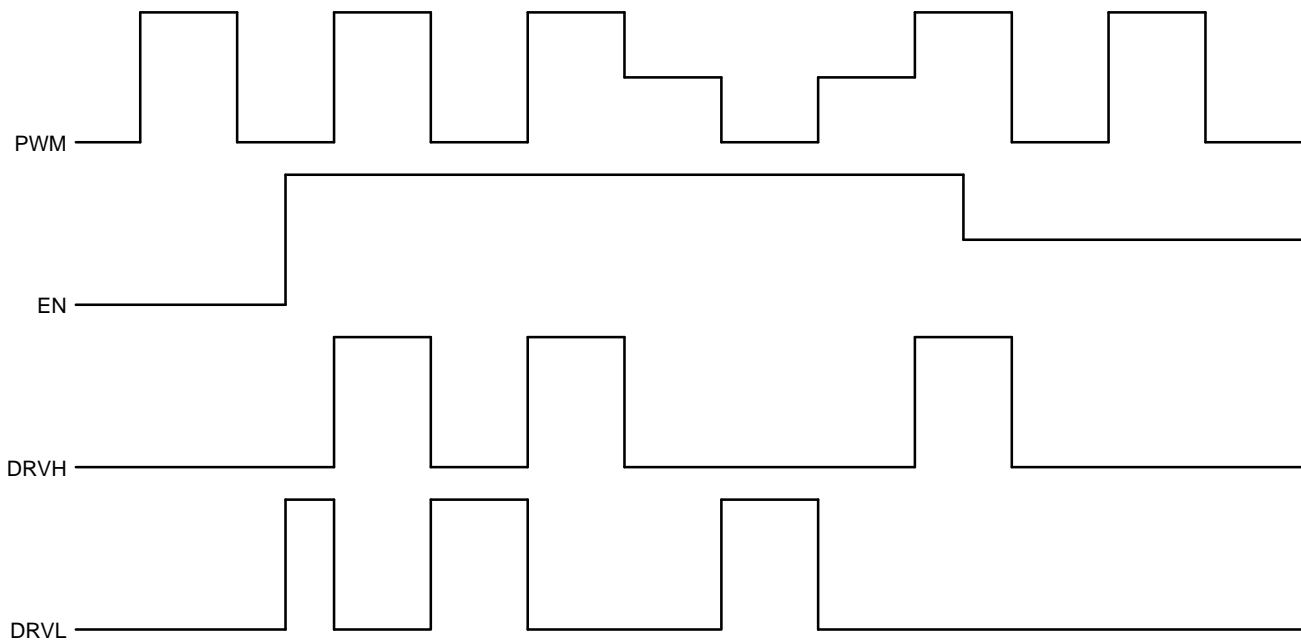

Figure 16. PWM/EN Logic Diagram

## APPLICATIONS INFORMATION

The NCP81253 gate driver is a single-phase MOSFET driver designed for driving N-channel MOSFETs in a synchronous buck converter topology. The NCP81253 is designed to work with single-phase IMVP8 controllers such as the NCP81206.

### Low-Side Driver

The low-side driver is designed to drive a ground-referenced low- $R_{DS(on)}$  N-channel MOSFET. The voltage supply for the low-side driver is internally connected to the VCC and GND pins.

### High-Side Driver

The high-side driver is designed to drive a floating low- $R_{DS(on)}$  N-channel MOSFET. The gate voltage for the high-side driver is developed by a bootstrap circuit referenced to the SW pin.

The bootstrap circuit is comprised of the integrated diode and an external bootstrap capacitor. When the NCP81253 is starting up, the SW pin is held at ground, allowing the bootstrap capacitor to charge up to VCC through the bootstrap diode. When the PWM input is driven high, the high-side driver will turn on the high-side MOSFET using the stored charge of the bootstrap capacitor. As the high-side MOSFET turns on, the SW pin rises. When the high-side MOSFET is fully turned on, SW will settle to VIN and BST will settle to VIN + VCC (excluding parasitic ringing).

### Bootstrap Circuit

The bootstrap circuit relies on an external charge storage capacitor ( $C_{BST}$ ) and an integrated diode to provide current to the high-side driver. A multi-layer ceramic capacitor (MLCC) with a value greater than 100 nF should be used for  $C_{BST}$ .

### Power Supply Decoupling

The NCP81253 can source and sink relatively large currents to the gate pins of the MOSFETs. In order to maintain a constant and stable supply voltage, a low-ESR capacitor should be placed near the VCC and GND pins. A MLCC between 1  $\mu$ F and 4.7  $\mu$ F is typically used.

### Undervoltage Lockout

DRVH and DRVL are low until VCC reaches the VCC UVLO threshold, typically 4.35 V. Once VCC reaches this threshold, the PWM signal will control DRVH and DRVL. There is a 200 mV hysteresis on VCC UVLO. There are pull-down resistors on DRVH, DRVL and SW to prevent the gates of the MOSFETs from accumulating enough charge to turn on when the driver is powered off.

### Three-State EN Input

Placing EN into a logic-high and logic-low will turn the driver on and off, respectively, as long as VCC is greater than the UVLO threshold. The EN threshold limits are specified



in the electrical characteristics table in this datasheet. Setting the voltage on EN to a mid-state level will pull both DRVH and DRVL low. Refer to Table 6 for the EN/PWM logic table.

Setting EN to the mid-state level can be used for body diode braking to quickly reduce the inductor current. By turning the LS FET off and having the current conduct through the LS FET body diode, the voltage at the switch node will be at a greater negative potential compared to having the LS FET on. This greater negative potential on switch node allows there to be a greater voltage across the output inductor, since the opposite terminal of the inductor is connected to the converter output voltage. The larger voltage across the inductor causes there to be a greater inductor current slew rate, allowing the current to decrease at a faster rate.

**Three-State PWM Input**

Switching PWM between logic-high and logic-low states will allow the driver to operate in continuous conduction mode as long as VCC is greater than the UVLO threshold and EN is high. The threshold limits are specified in the electrical characteristics table in this datasheet. Refer to Figure 15 for the gate timing diagrams and Table 6 for the EN/PWM logic table.

When PWM is set above PWM<sub>HI</sub>, DRVL will first turn off after a propagation delay of tpd<sub>DRVL</sub>. To ensure non-overlap between DRVL and DRVH, there is a delay of tpd<sub>DRVH</sub> from the time DRVL falls to 1 V, before DRVH is allowed to turn on.

When PWM falls below PWM<sub>LO</sub>, DRVH will first turn off after a propagation delay of tpd<sub>DRVH</sub>. To ensure non-overlap between DRVH and DRVL, there is a delay of tpd<sub>DRVL</sub> from the time DRVH – SW falls to 1 V, before DRVL is allowed to turn on.

When PWM enters the mid-state voltage range (and thereby exiting the logic high or logic low states), both DRVH and DRVL are pulled low for the non-overlap delay (tpdh). If PWM is still in the mid-state at the conclusion of the non-overlap delay, both DRVH and DRVL will remain in the off states.

To minimize power consumption when the NCP81253 is in a disabled state, the internal voltage rails that determine the low/mid/high PWM logic states are shut down when EN is low. When EN is brought high (while VCC is above the UVLO threshold), the PWM internal voltage rails are

brought up, but require some time to rise to their proper levels. To prevent a PWM signal from being interpreted incorrectly during this time, there is a delay from EN rising to the driver responding to PWM signals, which is set at a typical value of 50 μs.

**Table 6. EN/PWM LOGIC TABLE**

EN	PWM	DRVH	DRVL
LOW	X	LOW	LOW
HIGH	LOW	LOW	HIGH
HIGH	MID	LOW	LOW
HIGH	HIGH	HIGH	LOW
MID	LOW	LOW	LOW
MID	MID	LOW	LOW
MID	HIGH	LOW	LOW

**Thermal Considerations**

As power in the NCP81253 increases, it might become necessary to provide some thermal relief. The maximum power dissipation supported by the device is dependent upon board design and layout. Mounting pad configuration on the PCB, the board material, and the ambient temperature affect the rate of junction temperature rise for the part. When the NCP81253 has good thermal conductivity through the PCB, the junction temperature will be relatively low with high power applications. The maximum dissipation the NCP81253 can handle is given by:

$$P_{D(MAX)} = \frac{[T_{J(MAX)} - T_A]}{R_{\theta JA}} \quad \text{(eq. 1)}$$

Since T<sub>J</sub> is not recommended to exceed 150°C, the NCP81253, soldered on to a 645 mm<sup>2</sup> copper area, using 1 oz. copper and FR4, can dissipate up to 1.05 W when the ambient temperature (T<sub>A</sub>) is 25°C. The power dissipated by the NCP81253 can be calculated from the following equation:

$$P_D \approx VCC \cdot [(n_{HS} \cdot Qg_{HS} + n_{LS} \cdot Qg_{LS}) \cdot f + I_{standby}] \quad \text{(eq. 2)}$$

Where n<sub>HS</sub> and n<sub>LS</sub> are the number of high-side and low-side FETs, respectively, Qg<sub>HS</sub> and Qg<sub>LS</sub> are the gate charges of the high-side and low-side FETs, respectively and f is the switching frequency of the converter.

# NCP81253

## PACKAGE DIMENSIONS

DFN8 2x2  
CASE 506AA  
ISSUE E

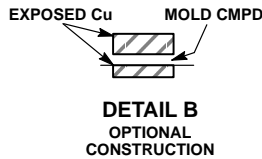
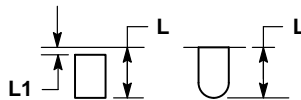
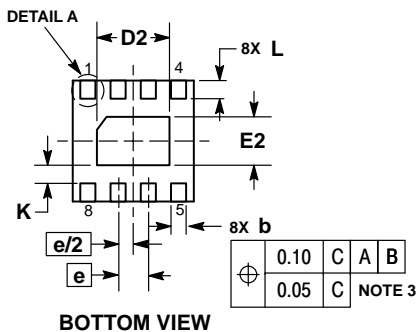
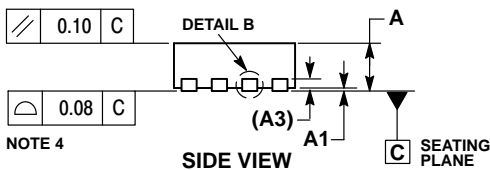
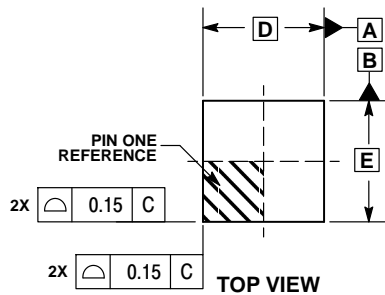

NOTES:

1. DIMENSIONING AND TOLERANCING PER ASME Y14.5M, 1994.
2. CONTROLLING DIMENSION: MILLIMETERS.
3. DIMENSION b APPLIES TO PLATED TERMINAL AND IS MEASURED BETWEEN 0.15 AND 0.20 MM FROM TERMINAL TIP.
4. COPLANARITY APPLIES TO THE EXPOSED PAD AS WELL AS THE TERMINALS.

DIM	MILLIMETERS	
	MIN	MAX
A	0.80	1.00
A1	0.00	0.05
A3	0.20	REF
b	0.20	0.30
D	2.00	BSC
D2	1.10	1.30
E	2.00	BSC
E2	0.70	0.90
e	0.50	BSC
K	0.30	REF
L	0.25	0.35
L1	---	0.10

### RECOMMENDED SOLDERING FOOTPRINT\*

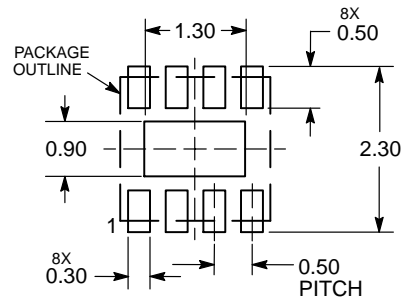

\*For additional information on our Pb-Free strategy and soldering details, please download the ON Semiconductor Soldering and Mounting Techniques Reference Manual, SOLDERRM/D.

ON Semiconductor and the are registered trademarks of Semiconductor Components Industries, LLC (SCILLC) or its subsidiaries in the United States and/or other countries. SCILLC owns the rights to a number of patents, trademarks, copyrights, trade secrets, and other intellectual property. A listing of SCILLC's product/patent coverage may be accessed at [www.onsemi.com/site/pdf/Patent-Marking.pdf](http://www.onsemi.com/site/pdf/Patent-Marking.pdf). SCILLC reserves the right to make changes without further notice to any products herein. SCILLC makes no warranty, representation or guarantee regarding the suitability of its products for any particular purpose, nor does SCILLC assume any liability arising out of the application or use of any product or circuit, and specifically disclaims any and all liability, including without limitation special, consequential or incidental damages. "Typical" parameters which may be provided in SCILLC data sheets and/or specifications can and do vary in different applications and actual performance may vary over time. All operating parameters, including "Typicals" must be validated for each customer application by customer's technical experts. SCILLC does not convey any license under its patent rights nor the rights of others. SCILLC products are not designed, intended, or authorized for use as components in systems intended for surgical implant into the body, or other applications intended to support or sustain life, or for any other application in which the failure of the SCILLC product could create a situation where personal injury or death may occur. Should Buyer purchase or use SCILLC products for any such unintended or unauthorized application, Buyer shall indemnify and hold SCILLC and its officers, employees, subsidiaries, affiliates, and distributors harmless against all claims, costs, damages, and expenses, and reasonable attorney fees arising out of, directly or indirectly, any claim of personal injury or death associated with such unintended or unauthorized use, even if such claim alleges that SCILLC was negligent regarding the design or manufacture of the part. SCILLC is an Equal Opportunity/Affirmative Action Employer. This literature is subject to all applicable copyright laws and is not for resale in any manner.

### PUBLICATION ORDERING INFORMATION

LITERATURE FULFILLMENT:  
Literature Distribution Center for ON Semiconductor  
P.O. Box 5163, Denver, Colorado 80217 USA  
Phone: 303-675-2175 or 800-344-3860 Toll Free USA/Canada  
Fax: 303-675-2176 or 800-344-3867 Toll Free USA/Canada  
Email: [orderlit@onsemi.com](mailto:orderlit@onsemi.com)

N. American Technical Support: 800-282-9855 Toll Free  
USA/Canada  
Europe, Middle East and Africa Technical Support:  
Phone: 421 33 790 2910  
Japan Customer Focus Center  
Phone: 81-3-5817-1050

ON Semiconductor Website: [www.onsemi.com](http://www.onsemi.com)  
Order Literature: <http://www.onsemi.com/orderlit>  
For additional information, please contact your local  
Sales Representative