



Is Now Part of



ON Semiconductor®

To learn more about ON Semiconductor, please visit our website at
www.onsemi.com

Please note: As part of the Fairchild Semiconductor integration, some of the Fairchild orderable part numbers will need to change in order to meet ON Semiconductor's system requirements. Since the ON Semiconductor product management systems do not have the ability to manage part nomenclature that utilizes an underscore (_), the underscore (_) in the Fairchild part numbers will be changed to a dash (-). This document may contain device numbers with an underscore (_). Please check the ON Semiconductor website to verify the updated device numbers. The most current and up-to-date ordering information can be found at www.onsemi.com. Please email any questions regarding the system integration to Fairchild_questions@onsemi.com.

ON Semiconductor and the ON Semiconductor logo are trademarks of Semiconductor Components Industries, LLC dba ON Semiconductor or its subsidiaries in the United States and/or other countries. ON Semiconductor owns the rights to a number of patents, trademarks, copyrights, trade secrets, and other intellectual property. A listing of ON Semiconductor's product/patent coverage may be accessed at www.onsemi.com/site/pdf/Patent-Marking.pdf. ON Semiconductor reserves the right to make changes without further notice to any products herein. ON Semiconductor makes no warranty, representation or guarantee regarding the suitability of its products for any particular purpose, nor does ON Semiconductor assume any liability arising out of the application or use of any product or circuit, and specifically disclaims any and all liability, including without limitation special, consequential or incidental damages. Buyer is responsible for its products and applications using ON Semiconductor products, including compliance with all laws, regulations and safety requirements or standards, regardless of any support or applications information provided by ON Semiconductor. "Typical" parameters which may be provided in ON Semiconductor data sheets and/or specifications can and do vary in different applications and actual performance may vary over time. All operating parameters, including "Typicals" must be validated for each customer application by customer's technical experts. ON Semiconductor does not convey any license under its patent rights nor the rights of others. ON Semiconductor products are not designed, intended, or authorized for use as a critical component in life support systems or any FDA Class 3 medical devices or medical devices with a same or similar classification in a foreign jurisdiction or any devices intended for implantation in the human body. Should Buyer purchase or use ON Semiconductor products for any such unintended or unauthorized application, Buyer shall indemnify and hold ON Semiconductor and its officers, employees, subsidiaries, affiliates, and distributors harmless against all claims, costs, damages, and expenses, and reasonable attorney fees arising out of, directly or indirectly, any claim of personal injury or death associated with such unintended or unauthorized use, even if such claim alleges that ON Semiconductor was negligent regarding the design or manufacture of the part. ON Semiconductor is an Equal Opportunity/Affirmative Action Employer. This literature is subject to all applicable copyright laws and is not for resale in any manner.

NC7WZ126

TinyLogic® UHS Dual Buffer with 3-STATE Outputs

General Description

The NC7WZ126 is a Dual Non-Inverting Buffer with independent active HIGH enables for the 3-STATE outputs. The Ultra High Speed device is fabricated with advanced CMOS technology to achieve superior switching performance with high output drive while maintaining low static power dissipation over a broad V_{CC} operating range. The device is specified to operate over the 1.65V to 5.5V V_{CC} operating range. The inputs and outputs are high impedance when V_{CC} is 0V. Inputs tolerate voltages up to 5.5V independent of V_{CC} operating range. Outputs tolerate voltages above V_{CC} when in the 3-STATE condition.

Features

- Space saving US8 surface mount package
- MicroPak™ Pb-Free leadless package
- Ultra High Speed; t_{PD} 2.6 ns Typ into 50 pF at 5V V_{CC}
- High Output Drive; ± 24 mA at 3V V_{CC}
- Broad V_{CC} Operating Range: 1.65V to 5.5V
- Matches the performance of LCX when operated at 3.3V V_{CC}
- Power down high impedance inputs/outputs
- Overvoltage tolerant inputs facilitate 5V to 3V translation
- Outputs are overvoltage tolerant in 3-STATE mode
- Patented noise/EMI reduction circuitry implemented

Ordering Code:

| Order Number | Package Number | Product Code Top Mark | Package Description | Supplied As |
|--------------|----------------|-----------------------|---|---------------------------|
| NC7WZ126K8X | MAB08A | WZ26 | 8-Lead US8, JEDEC MO-187, Variation CA 3.1mm Wide | 3k Units on Tape and Reel |
| NC7WZ126L8X | MAC08A | T6 | Pb-Free 8-Lead MicroPak, 1.6 mm Wide | 5k Units on Tape and Reel |

Pb-Free package per JEDEC J-STD-020B.

Logic Symbol

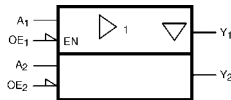

Pin Descriptions

| Pin Names | Description |
|-----------|-----------------------------------|
| OE_n | Enable Inputs for 3-STATE Outputs |
| A_n | Inputs |
| Y_n | 3-STATE Outputs |

Function Table

| Inputs | | Output |
|--------|-------|--------|
| OE | A_n | Y_n |
| H | L | L |
| H | H | H |
| L | L | Z |
| L | H | Z |

H = HIGH Logic Level L = LOW Logic Level Z = 3-STATE

TinyLogic® is a registered trademark of Fairchild Semiconductor Corporation.

Connection Diagrams

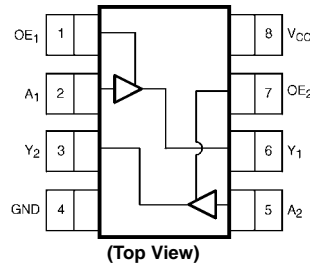

Pad Assignments for MicroPak

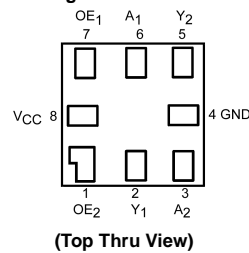

MicroPak™ is a trademark of Fairchild Semiconductor Corporation.

Absolute Maximum Ratings (Note 1)

| | |
|--|-----------------|
| Supply Voltage (V_{CC}) | -0.5V to +7.0V |
| DC Input Voltage (V_{IN}) (Note 2) | -0.5V to +7.0V |
| DC Output Voltage (V_{OUT}) | -0.5V to +7.0V |
| DC Input Diode Current (I_{IK}) @ $V_{IN} < 0V$ | -50 mA |
| DC Output Diode Current (I_{OK}) @ $V_{OUT} < 0V$ | -50 mA |
| DC Output Source/Sink Current (I_{OUT}) | ± 50 mA |
| DC V_{CC}/GND Current (I_{CC}/I_{GND}) | ± 100 mA |
| Storage Temperature Range (T_{STG}) | -65°C to +150°C |
| Junction Temperature under Bias (T_J) | +150°C |
| Junction Lead Temperature (T_L) (Soldering, 10 seconds) | +260°C |
| Power Dissipation (P_D) @ +85°C | 250 mW |

Recommended Operating Conditions (Note 3)

| | |
|--|-------------------|
| Supply Voltage Operating (V_{CC}) | 1.65V to 5.5V |
| Supply Voltage Data Retention (V_{CC}) | 1.5V to 5.5V |
| Input Voltage (V_{IN}) | 0V to 5.5V |
| Output Voltage (V_{OUT}) | |
| Active State | 0V to V_{CC} |
| 3-State | 0V to 5.5V |
| Operating Temperature (T_A) | -40°C to +85°C |
| Input Rise and Fall Time (t_r, t_f) | |
| $V_{CC} = 1.8V, 0.15V, 2.5V \pm 0.2V$ | 0 ns/V to 20 ns/V |
| $V_{CC} = 3.8V \pm 0.3V$ | 0 ns/V to 10 ns/V |
| $V_{CC} = 5.0V \pm 0.5V$ | 0 ns/V to 5 ns/V |
| Thermal Resistance (θ_{JA}) | 250°C/W |

Note 1: Absolute maximum ratings are DC values beyond which the device may be damaged or have its useful life impaired. The datasheet specifications should be met, without exception, to ensure that the system design is reliable over its power supply, temperature, and output/input loading variables. Fairchild does not recommend operation outside datasheet specifications.

Note 2: The input and output negative voltage ratings may be exceeded if the input and output diode current ratings are observed.

Note 3: Unused inputs must be held HIGH or LOW. They may not float.

DC Electrical Characteristics

| Symbol | Parameter | V_{CC} (V) | $T_A = +25^\circ C$ | | | $T_A = -40^\circ C$ to $+85^\circ C$ | | Unit | Conditions | |
|-----------|---------------------------|----------------------------|-------------------------------|------------------------------|----------------------------|--------------------------------------|-----|----------------------------------|---|----------------------|
| | | | Min | Typ | Max | Min | Max | | | |
| V_{IH} | HIGH Level Input Voltage | 1.65 to 1.95 2.3 to 5.5 | 0.75 V_{CC} 0.7 V_{CC} | | | 0.75 V_{CC} 0.7 V_{CC} | | V | | |
| V_{IL} | LOW Level Input Voltage | 1.65 to 1.95 2.3 to 5.5 | 0.25 V_{CC} 0.3 V_{CC} | | | 0.25 V_{CC} 0.3 V_{CC} | | V | | |
| V_{OH} | HIGH Level Output Voltage | 1.65 2.3 3.0 4.5 | 1.55 2.2 2.9 4.4 | 1.65 2.3 3.0 4.5 | 1.55 2.2 2.9 4.4 | | V | $V_{IN} = V_{IH}$ or V_{IL} | $I_{OH} = -100 \mu A$ | |
| | | 1.65 2.3 3.0 4.5 | 1.29 1.9 2.4 3.8 | 1.52 2.15 2.80 4.20 | 1.29 1.9 2.4 3.8 | | V | $V_{IN} = V_{IH}$ or V_{IL} | $I_{OH} = -4$ mA $I_{OH} = -8$ mA $I_{OH} = -16$ mA $I_{OH} = -24$ mA $I_{OH} = -32$ mA | |
| V_{OL} | LOW Level Output Voltage | 1.65 2.3 3.0 4.5 | 0.0 0.0 0.0 0.0 | | | 0.10 0.10 0.10 0.10 | | V | $V_{IN} = V_{IH}$ or V_{IL} | $I_{OL} = 100 \mu A$ |
| | | 1.65 2.3 3.0 4.5 | 0.08 0.10 0.15 0.22 | 0.24 0.3 0.4 0.55 | 0.24 0.3 0.4 0.55 | | V | $V_{IN} = V_{IH}$ or V_{IL} | $I_{OL} = 4$ mA $I_{OL} = 8$ mA $I_{OL} = 16$ mA $I_{OL} = 24$ mA $I_{OL} = 32$ mA | |
| I_{IN} | Input Leakage Current | 0 to 5.5 | ± 0.1 | | | ± 1 | | μA | $V_{IN} = 5.5V, GND$ | |
| I_{OZ} | 3-STATE Output Leakage | 1.65 to 5.5 | ± 0.5 | | | ± 5 | | μA | $V_{IN} = V_{IH}$ or V_{IL} $0 \leq V_{OUT} \leq 5.5V$ | |
| I_{OFF} | Power Off Leakage Current | 0.0 | 1 | | | 10 | | μA | V_{IN} or $V_{OUT} = 5.5V$ | |
| I_{CC} | Quiescent Supply Current | 1.65 to 5.5 | 1 | | | 10 | | μA | $V_{IN} = 5.5V, GND$ | |

| Noise Characteristics | | | | | | | | | | |
|--|---|------------------------|------------------------|-----|-------|---------------------------------|------|-------|--|---------------|
| Symbol | Parameter | V _{CC} (V) | T _A = +25°C | | Units | Conditions | | | | |
| | | | Typ | Max | | | | | | |
| V _{OLP} (Note 4) | Quiet Output Maximum Dynamic V _{OL} | 5.0 | | 1.0 | V | C _L = 50 pF | | | | |
| V _{OLV} (Note 4) | Quiet Output Minimum Dynamic V _{OL} | 5.0 | | 1.0 | V | C _L = 50 pF | | | | |
| V _{OHV} (Note 4) | Quiet Output Minimum Dynamic V _{OH} | 5.0 | | 4.0 | V | C _L = 50 pF | | | | |
| V _{IHD} (Note 4) | Minimum HIGH Level Dynamic Input Voltage | 5.0 | | 3.5 | V | C _L = 50 pF | | | | |
| V _{ILD} (Note 4) | Maximum LOW Level Dynamic Input Voltage | 5.0 | | 1.5 | V | C _L = 50 pF | | | | |
| Note 4: Parameter guaranteed by design. | | | | | | | | | | |
| AC Electrical Characteristics | | | | | | | | | | |
| Symbol | Parameter | V _{CC} (V) | T _A = +25°C | | | T _A = -40°C to +85°C | | Units | Conditions | Figure Number |
| | | | Min | Typ | Max | Min | Max | | | |
| t _{PLH} | Propagation Delay A _n to Y _n | 1.8 ± 0.15 | 2.0 | | 12.0 | 2.0 | 13.0 | ns | C _L = 15 pF RD = 1 MΩ S ₁ = OPEN | Figures 1, 3 |
| t _{PHL} | | 2.5 ± 0.2 | 1.0 | | 7.5 | 1.0 | 8.0 | | | |
| | | 3.3 ± 0.3 | 0.8 | | 5.2 | 0.8 | 5.5 | | | |
| | | 5.0 ± 0.5 | 0.5 | | 4.5 | 0.5 | 4.8 | | | |
| t _{PLH} | Propagation Delay A _n to Y _n | 3.3 ± 0.3 | 1.2 | | 5.7 | 1.2 | 6.0 | ns | C _L = 50 pF RD = 500Ω S ₁ = OPEN | Figures 1, 3 |
| t _{PHL} | | 5.0 ± 0.5 | 0.8 | | 5.0 | 0.8 | 5.3 | | | |
| t _{OSLH} | Output to Output Skew (Note 5) | 3.3 ± 0.3 | | | 1.0 | | 1.0 | ns | C _L = 50 pF RD = 500Ω S ₁ = OPEN | Figures 1, 3 |
| t _{OSHL} | | 5.0 ± 0.5 | | | 0.8 | | 0.8 | | | |
| t _{PZL} | Output Enable Time | 1.8 ± 0.15 | 3.0 | | 14.0 | 3.0 | 15.0 | ns | C _L = 50 pF RD, RU = 500Ω S ₁ = GND for t _{PZH} S ₁ = V _I for t _{PZL} V _I = 2 × V _{CC} | Figures 1, 3 |
| t _{PZH} | | 2.5 ± 0.2 | 1.8 | | 8.5 | 1.8 | 9.0 | | | |
| | | 3.3 ± 0.3 | 1.2 | | 6.2 | 1.2 | 6.5 | | | |
| | | 5.0 ± 0.5 | 0.8 | | 5.5 | 0.8 | 5.8 | | | |
| t _{PLZ} | Output Disable Time | 1.8 ± 0.15 | 2.5 | | 12.0 | 2.5 | 13.0 | ns | C _L = 50 pF RD, RU = 500Ω S ₁ = GND for t _{PHZ} S ₁ = V _I for t _{PLZ} V _I = 2 × V _{CC} | Figures 1, 3 |
| t _{PHZ} | | 2.5 ± 0.2 | 1.5 | | 8.0 | 1.5 | 8.5 | | | |
| | | 3.3 ± 0.3 | 0.8 | | 5.7 | 0.8 | 6.0 | | | |
| | | 5.0 ± 0.5 | 0.3 | | 4.7 | 0.3 | 5.0 | | | |
| C _{IN} | Input Capacitance | 0 | | 2.5 | | | | pF | | |
| C _{OUT} | Output Capacitance | 5.0 | | 4 | | | | | | |
| C _{PD} | Power Dissipation Capacitance | 3.3 | | 10 | | | | pF | (Note 6) | Figure 2 |
| | | 5.0 | | 12 | | | | | | |
| Note 5: Parameter guaranteed by design. t _{OSLH} = t _{PLHmax} - t _{PLHmin} ; t _{OSHL} = t _{PHLmax} - t _{PHLmin} . | | | | | | | | | | |
| Note 6: C _{PD} is defined as the value of the internal equivalent capacitance which is derived from dynamic operating current consumption (I _{CCD}) at no output loading and operating at 50% duty cycle. (See Figure 2.) C _{PD} is related to I _{CCD} dynamic operating current by the expression: I _{CCD} = (CPD) (V _{CC}) (f _N) + (I _{CC} static). | | | | | | | | | | |

AC Loading and Waveforms

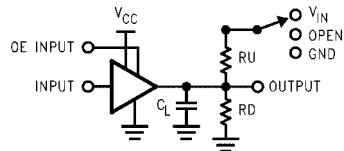

C_L includes load and stray capacitance
 Input PRR = 1.0 MHz, $t_w = 500$ ns

FIGURE 1. AC Test Circuit

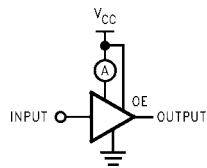

Input = AC Waveform; $t_r = t_f = 1.8$ ns;
 PRR = 10 MHz; Duty Cycle = 50%

FIGURE 2. I_{CCD} Test Circuit

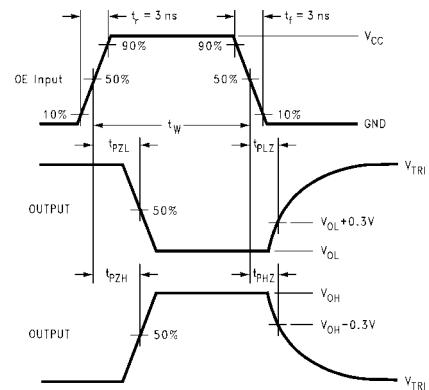
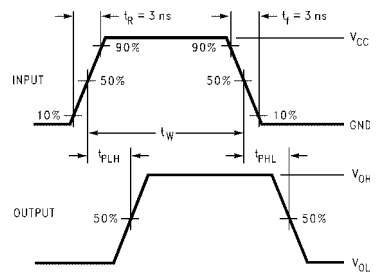

FIGURE 3. AC Waveforms

Tape and Reel Specification

TAPE FORMAT for US8

| Package Designator | Tape Section | Number Cavities | Cavity Status | Cover Tape Status |
|--------------------|--------------------|-----------------|---------------|-------------------|
| K8X | Leader (Start End) | 125 (typ) | Empty | Sealed |
| | Carrier | 3000 | Filled | Sealed |
| | Trailer (Hub End) | 75 (typ) | Empty | Sealed |

TAPE DIMENSIONS inches (millimeters)

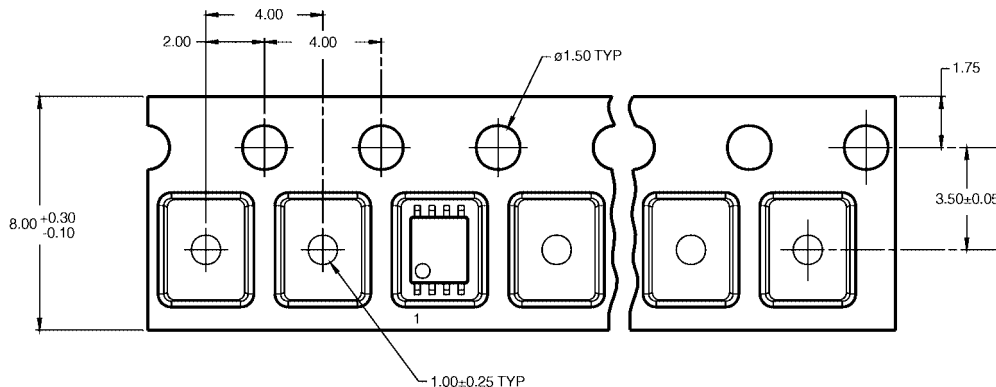

TAPE FORMAT for MicroPak

| Package Designator | Tape Section | Number Cavities | Cavity Status | Cover Tape Status |
|--------------------|--------------------|-----------------|---------------|-------------------|
| L8X | Leader (Start End) | 125 (typ) | Empty | Sealed |
| | Carrier | 3000 | Filled | Sealed |
| | Trailer (Hub End) | 75 (typ) | Empty | Sealed |

TAPE DIMENSIONS inches (millimeters)

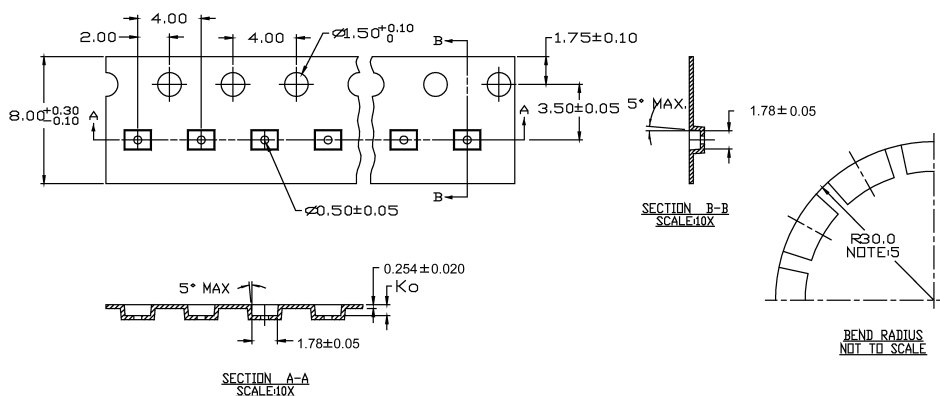

Tape and Reel Specification (Continued)

REEL DIMENSIONS inches (millimeters)

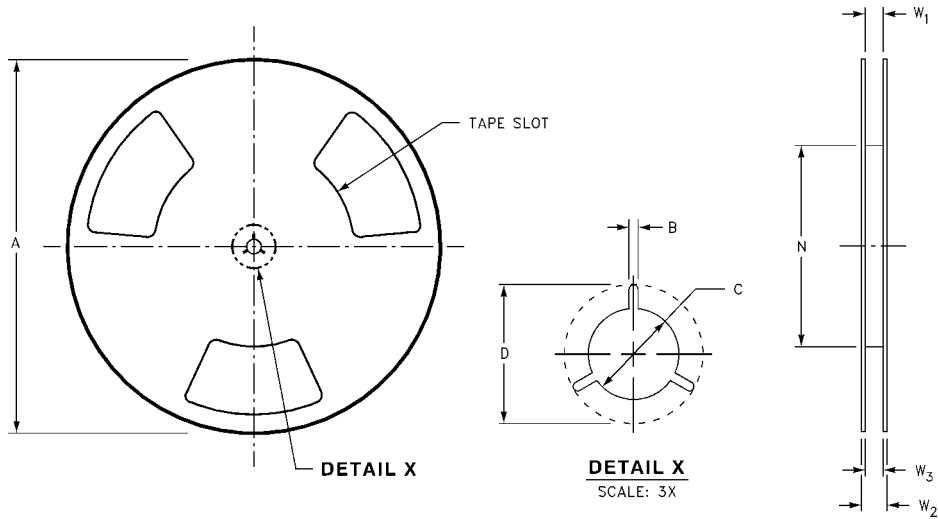

| Tape Size | A | B | C | D | N | W1 | W2 | W3 |
|-----------|----------------|-----------------|------------------|------------------|------------------|---|------------------|--|
| 8 mm | 7.0 (177.8) | 0.059 (1.50) | 0.512 (13.00) | 0.795 (20.20) | 2.165 (55.00) | $0.331 + 0.059/-0.000$ ($8.40 + 1.50/-0.00$) | 0.567 (14.40) | $W1 + 0.078/-0.039$ ($W1 + 2.00/-1.00$) |

Physical Dimensions inches (millimeters) unless otherwise noted

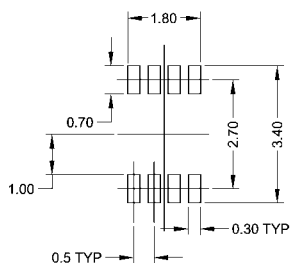
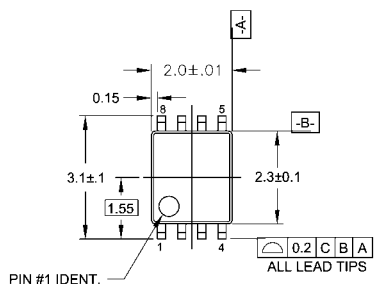

LAND PATTERN RECOMMENDATION

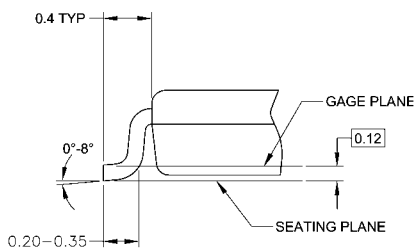
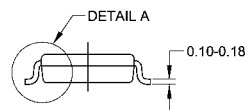
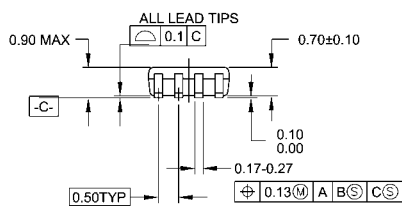

DETAIL A

NOTES:

- A. CONFORMS TO JEDEC REGISTRATION MO-187
- B. DIMENSIONS ARE IN MILLIMETERS.
- C. DIMENSIONS ARE EXCLUSIVE OF BURRS, MOLD FLASH, AND TIE BAR EXTRUSIONS.
- D. DIMENSIONS AND TOLERANCES PER ANSI Y14.5M, 1982.

MAB08AREVC

**8-Lead US8, JEDEC MO-187, Variation CA 3.1mm Wide
Package Number MAB08A**

Physical Dimensions inches (millimeters) unless otherwise noted (Continued)

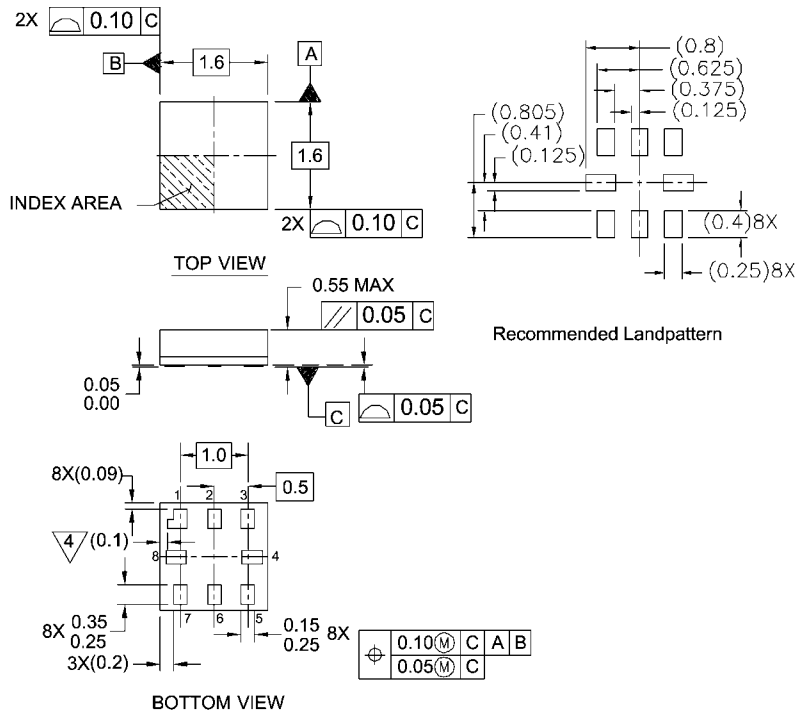

Notes:

1. PACKAGE CONFORMS TO JEDEC MO-255 VARIATION UAAD
2. DIMENSIONS ARE IN MILLIMETERS
3. DRAWING CONFORMS TO ASME Y.14M-1994
4. PIN 1 FLAG, END OF PACKAGE OFFSET.

MAC08AREVC

**Pb-Free 8-Lead MicroPak, 1.6 mm Wide
Package Number MAC08A**

Fairchild does not assume any responsibility for use of any circuitry described, no circuit patent licenses are implied and Fairchild reserves the right at any time without notice to change said circuitry and specifications.

LIFE SUPPORT POLICY

FAIRCHILD'S PRODUCTS ARE NOT AUTHORIZED FOR USE AS CRITICAL COMPONENTS IN LIFE SUPPORT DEVICES OR SYSTEMS WITHOUT THE EXPRESS WRITTEN APPROVAL OF THE PRESIDENT OF FAIRCHILD SEMICONDUCTOR CORPORATION. As used herein:

1. Life support devices or systems are devices or systems which, (a) are intended for surgical implant into the body, or (b) support or sustain life, and (c) whose failure to perform when properly used in accordance with instructions for use provided in the labeling, can be reasonably expected to result in a significant injury to the user.
2. A critical component in any component of a life support device or system whose failure to perform can be reasonably expected to cause the failure of the life support device or system, or to affect its safety or effectiveness.

www.fairchildsemi.com

ON Semiconductor and  are trademarks of Semiconductor Components Industries, LLC dba ON Semiconductor or its subsidiaries in the United States and/or other countries. ON Semiconductor owns the rights to a number of patents, trademarks, copyrights, trade secrets, and other intellectual property. A listing of ON Semiconductor's product/patent coverage may be accessed at www.onsemi.com/site/pdf/Patent-Marking.pdf. ON Semiconductor reserves the right to make changes without further notice to any products herein. ON Semiconductor makes no warranty, representation or guarantee regarding the suitability of its products for any particular purpose, nor does ON Semiconductor assume any liability arising out of the application or use of any product or circuit, and specifically disclaims any and all liability, including without limitation special, consequential or incidental damages. Buyer is responsible for its products and applications using ON Semiconductor products, including compliance with all laws, regulations and safety requirements or standards, regardless of any support or applications information provided by ON Semiconductor. "Typical" parameters which may be provided in ON Semiconductor data sheets and/or specifications can and do vary in different applications and actual performance may vary over time. All operating parameters, including "Typicals" must be validated for each customer application by customer's technical experts. ON Semiconductor does not convey any license under its patent rights nor the rights of others. ON Semiconductor products are not designed, intended, or authorized for use as a critical component in life support systems or any FDA Class 3 medical devices or medical devices with a same or similar classification in a foreign jurisdiction or any devices intended for implantation in the human body. Should Buyer purchase or use ON Semiconductor products for any such unintended or unauthorized application, Buyer shall indemnify and hold ON Semiconductor and its officers, employees, subsidiaries, affiliates, and distributors harmless against all claims, costs, damages, and expenses, and reasonable attorney fees arising out of, directly or indirectly, any claim of personal injury or death associated with such unintended or unauthorized use, even if such claim alleges that ON Semiconductor was negligent regarding the design or manufacture of the part. ON Semiconductor is an Equal Opportunity/Affirmative Action Employer. This literature is subject to all applicable copyright laws and is not for resale in any manner.

PUBLICATION ORDERING INFORMATION

LITERATURE FULFILLMENT:

Literature Distribution Center for ON Semiconductor
19521 E. 32nd Pkwy, Aurora, Colorado 80011 USA
Phone: 303-675-2175 or 800-344-3860 Toll Free USA/Canada
Fax: 303-675-2176 or 800-344-3867 Toll Free USA/Canada
Email: orderlit@onsemi.com

N. American Technical Support: 800-282-9855 Toll Free
USA/Canada
Europe, Middle East and Africa Technical Support:
Phone: 421 33 790 2910
Japan Customer Focus Center
Phone: 81-3-5817-1050

ON Semiconductor Website: www.onsemi.com
Order Literature: <http://www.onsemi.com/orderlit>
For additional information, please contact your local
Sales Representative