

BCD-TO-DECIMAL DECODER

S5442 N7442

S5442-B,F,W • N7442-B

DIGITAL 54/74 TTL SERIES

DESCRIPTION

The 54/7442 BCD-to-Decimal Decoder is a TTL MSI array utilized in decoding and logic conversion applications. The 54/7442 decodes a four bit BCD number to one of ten outputs.

LOGIC DIAGRAM

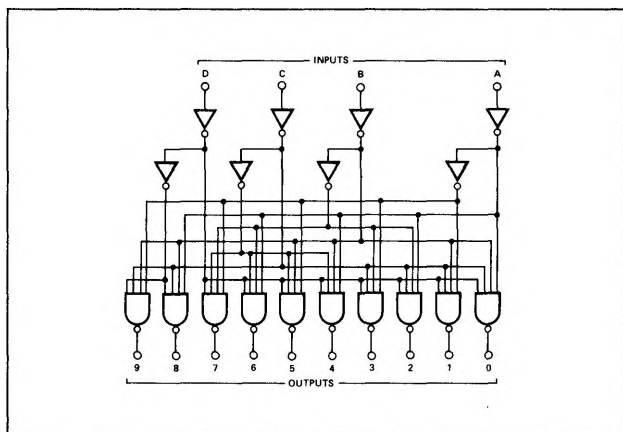

PIN CONFIGURATIONS

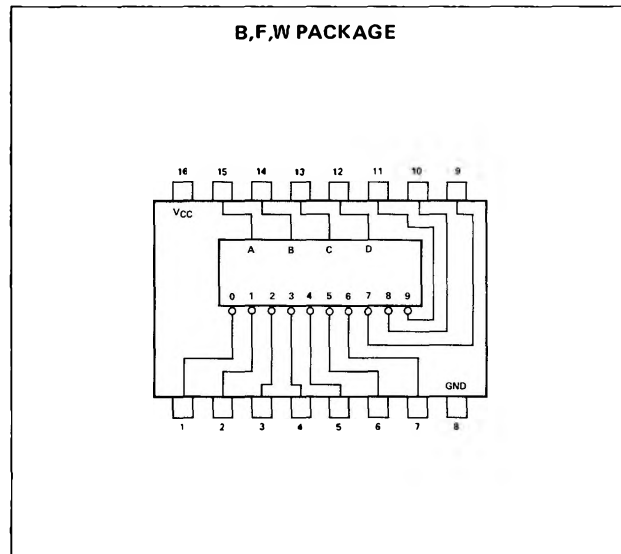

TRUTH TABLE

S5442/N7442 BCD INPUT				ALL TYPES DECIMAL OUTPUT									
D	C	B	A	0	1	2	3	4	5	6	7	8	9
0	0	0	0	0	1	1	1	1	1	1	1	1	1
0	0	0	1	0	1	1	1	1	1	1	1	1	1
0	0	1	0	1	1	1	1	1	1	1	1	1	1
0	0	1	1	0	1	1	1	1	1	1	1	1	1
0	1	0	0	1	1	1	1	1	1	1	1	1	1
0	1	0	1	0	1	1	1	1	1	1	1	1	1
0	1	1	0	1	1	1	1	1	1	1	1	1	1
0	1	1	1	0	1	1	1	1	1	1	1	1	1
1	0	0	0	1	1	1	1	1	1	1	1	1	1
1	0	0	1	0	1	1	1	1	1	1	1	1	1
1	0	1	0	1	1	1	1	1	1	1	1	1	1
1	0	1	1	0	1	1	1	1	1	1	1	1	1
1	1	0	0	1	1	1	1	1	1	1	1	1	1
1	1	0	1	0	1	1	1	1	1	1	1	1	1
1	1	1	0	1	1	1	1	1	1	1	1	1	1
1	1	1	1	0	1	1	1	1	1	1	1	1	1
1	1	1	1	1	1	1	1	1	1	1	1	1	1

RECOMMENDED OPERATING CONDITIONS

	MIN	NOM	MAX	UNIT
Supply Voltage V_{CC} : S5442 Circuits	4.5	5	5.5	V
N7442 Circuits	4.75	5	5.25	V
Normalized Fan-Out from each Output, N			10	

SIGNETICS DIGITAL 54/74 TTL SERIES - S5442 • N7442

ELECTRICAL CHARACTERISTICS (over recommended operating free-air temperature range unless otherwise noted)

PARAMETER		TEST CONDITIONS *	MIN	TYP**	MAX	UNIT
$V_{in(1)}$	Input voltage required to ensure logical 1 at any input terminal	$V_{CC} = \text{MIN}$	2			V
$V_{in(0)}$	Input voltage required to ensure logical 0 at any input terminal	$V_{CC} = \text{MIN}$			0.8	V
$V_{out(1)}$	Logical 1 output voltage	$V_{CC} = \text{MIN}, V_{in(1)} = 2V, V_{in(0)} = 0.8V, I_{load} = -400\mu A$	2.4			V
$V_{out(0)}$	Logical 0 output voltage	$V_{CC} = \text{MIN}, V_{in(1)} = 2V, V_{in(0)} = 0.8V, I_{sink} = 16mA$			0.4	V
$I_{in(1)}$	Logical 1 level input current (each input)	$V_{CC} = \text{MAX}, V_{in} = 2.4V$			40	μA
		$V_{CC} = \text{MAX}, V_{in} = 5.5V$			1	mA
$I_{in(0)}$	Logical 0 level input current (each input)	$V_{CC} = \text{MAX}, V_{in} = 0.4V$			-1.6	mA
I_{OS}	Short-circuit output current†	$V_{CC} = \text{MAX},$ S5442	-20		-55	mA
		N7442	-18		-55	mA
I_{CC}	Supply current	$V_{CC} = \text{MAX},$ S5442		28	41	mA
		N7442		18	56	mA

SWITCHING CHARACTERISTICS, $V_{CC} = 5V, T_A = 25^\circ C, N = 10$

PARAMETER		TEST CONDITIONS		MIN	TYP	MAX	UNIT
t_{pd0}	Propagation delay time to logical 0 level through two logic levels	$C_L = 15pF,$	$R_L = 400\Omega$	10	22	30	ns
t_{pd0}	Propagation delay time to logical 0 level through three logic levels	$C_L = 15pF,$	$R_L = 400\Omega$		23	35	ns
t_{pd1}	Propagation delay time to logical 1 level through two logic levels	$C_L = 15pF,$	$R_L = 400\Omega$	10	17	25	ns
t_{pd1}	Propagation delay time to logical 1 level through three logic levels	$C_L = 15pF,$	$R_L = 400\Omega$		26	35	ns

* For conditions shown as MIN or MAX, use the appropriate value specified under recommended operating conditions for the applicable device type.

** All typical values are at $V_{CC} = 5V, T_A = 25^\circ C$.

† Not more than one output should be shorted at a time.