



# 1.9 GHz GaAs Low Noise Amplifier

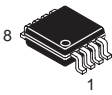
Designed primarily for use in wireless Personal Communication Systems (PCS) applications such as Digital European Cordless Telephone (DECT), Japan's Personal Handy System (PHS) and the emerging North American systems as a preamp for discrete or integrated downmixers. The MRFIC1808DM is a two-stage low noise amplifier in a low-cost Micro-8 package. The amplifier can be matched to optimize gain or noise figure with simple off-chip input matching. The design employs a novel stacked MESFET design which reuses bias current for the highest gain at minimal current. A CMOS compatible Rx Enable pin allows for very low standby current while the system is in transmit mode.

- Usable Frequency Range = 1.7 to 2.1 GHz
- 18 dB Typ Gain
- 1.6 dB Typ Noise Figure
- Simple Off-chip Matching for Maximum Gain/Noise Figure Flexibility
- High Reverse Isolation = 32 dB (Typ)
- Single Bias Supply = 2.7 to 4.5 V
- Low Standby Current = 8  $\mu$ A (Typ)
- Low Cost Surface Mount Plastic Package
- Device Marking = M1808

## MRFIC1808

### 1.9 GHz GaAs LOW NOISE AMPLIFIER

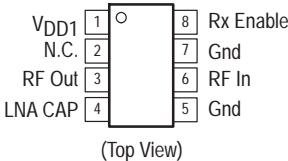
#### SEMICONDUCTOR TECHNICAL DATA



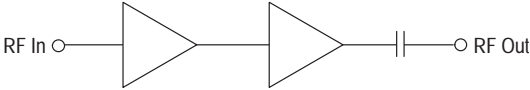
(Scale 2:1)

**DM SUFFIX**  
PLASTIC PACKAGE  
CASE 846A  
(Micro-8, Tape & Reel Only)

#### PIN CONNECTIONS



#### Simplified Block Diagram



This device contains 5 active transistors.

#### ORDERING INFORMATION

Device	Operating Temp Range	Package
MRFIC1808DMR2	T <sub>A</sub> = -30 to 85°C	Micro-8

**MAXIMUM RATINGS** ( $T_A = 25^\circ\text{C}$ , unless otherwise noted)

Rating	Symbol	Value	Unit
Supply Voltage	$V_{DD}$	5.5	Vdc
RF Input Power	$P_{RF}$	3.0	dBm
Enable Voltage	Rx Enable	5.5	Vdc
Storage Temperature Range	$T_{stg}$	-65 to 150	$^\circ\text{C}$
Operating Ambient Temperature	$T_A$	-30 to 85	$^\circ\text{C}$

- NOTES:** 1. Maximum Ratings are those values beyond which damage to the device may occur. Functional operation should be restricted to the limits in the Recommended Operating Conditions or Electrical Characteristics tables.  
 2. Meets Human Body Model (HBM)  $\leq 500$  V and Machine Model (MM)  $\leq 200$  V.  
 3. ESD data available upon request.

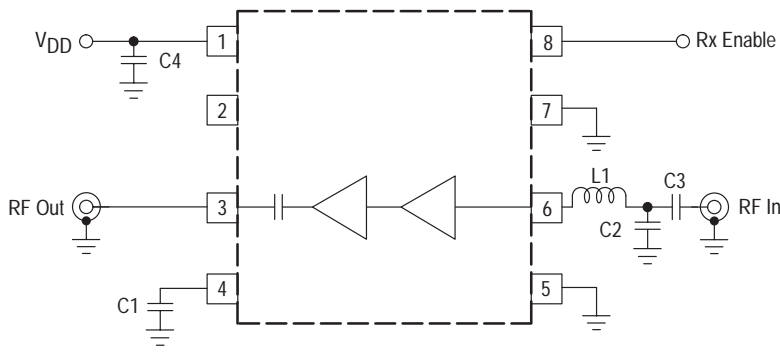
**RECOMMENDED OPERATING CONDITIONS**

Parameter	Symbol	Min	Typ	Max	Unit
RF Frequency	$f_{RF}$	1.7	-	2.1	GHz
Supply Voltage	$V_{DD}$	2.7	-	4.5	Vdc
Rx Enable Voltage, ON	Rx Enable	2.7	-	$V_{DD}$	Vdc
Rx Enable Voltage, OFF	Rx Enable	0	-	0.2	Vdc

**ELECTRICAL CHARACTERISTICS** ( $V_{DD} = 3.0$  V,  $T_A = 25^\circ\text{C}$ ,  $RF = -30$  dBm @ 1.9 GHz, Rx Enable = 3.0 V, unless otherwise noted. Tested in Circuit Shown in Figure 1)

Characteristic	Symbol	Min	Typ	Max	Unit
RF Gain	-	16	18	-	dB
SSB Noise Figure	-	-	1.6	-	dB
RF Output 3rd Order Intercept Point	-	-	13	-	dBm
Output 1 dB Gain Compression	-	-3.0	1.0	-	dBm
Reverse Isolation ( $s_{12}$ )	-	-	-34	-	dB
Input Return Loss	-	-	-12	-	dB
Output Return Loss	-	-	-15	-	dB
Supply Current, Rx Mode	-	-	5.0	7.5	mA
Supply Current, Standby Mode (Rx Enable = 0 V)	-	-	-	50	$\mu\text{A}$

**Figure 1. Applications Circuit Configuration**

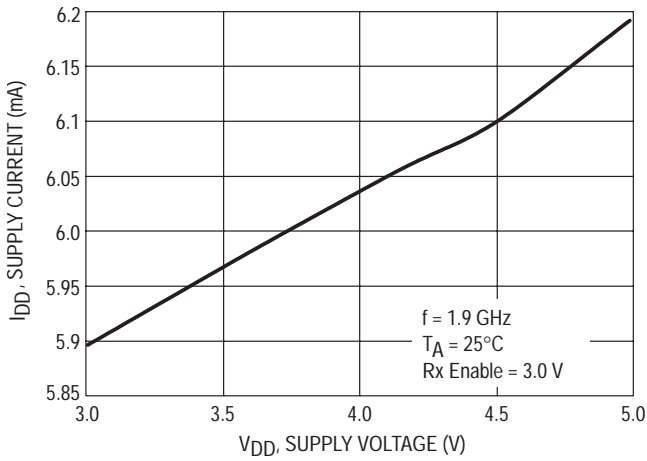


- C1 1.4 pF
- C2 1.4 pF
- C3, C4 22 pF
- L1 4.7 nH

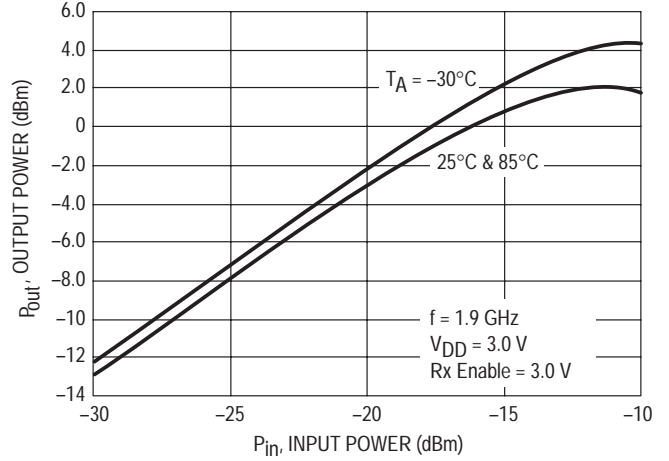


**TYPICAL CHARACTERISTICS**

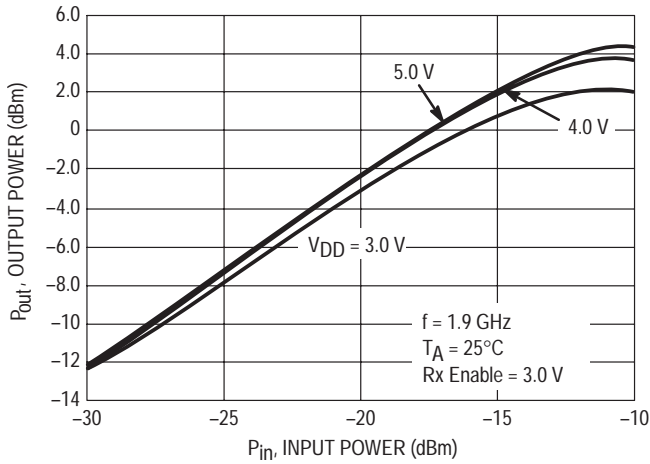
**Figure 2. Supply Current versus Voltage**



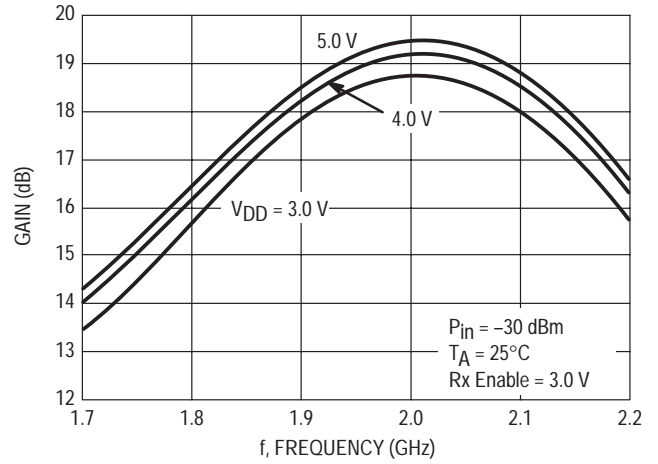
**Figure 3. Output Power versus Input Power**



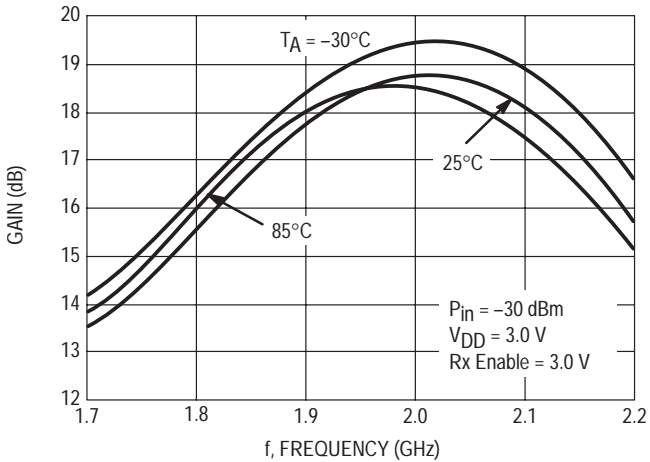
**Figure 4. Output Power versus Input Power**



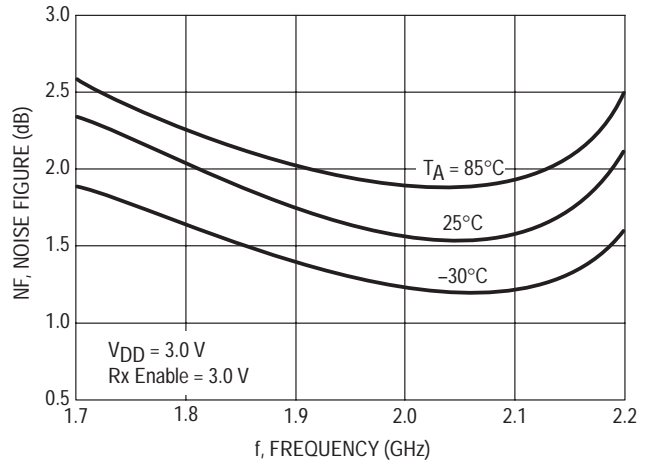
**Figure 5. Gain versus Frequency**

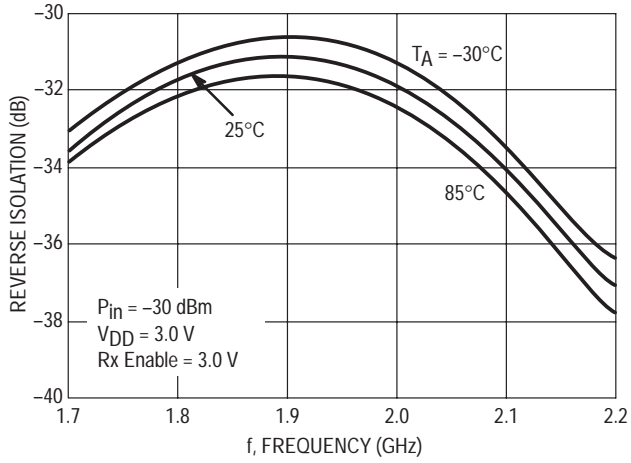
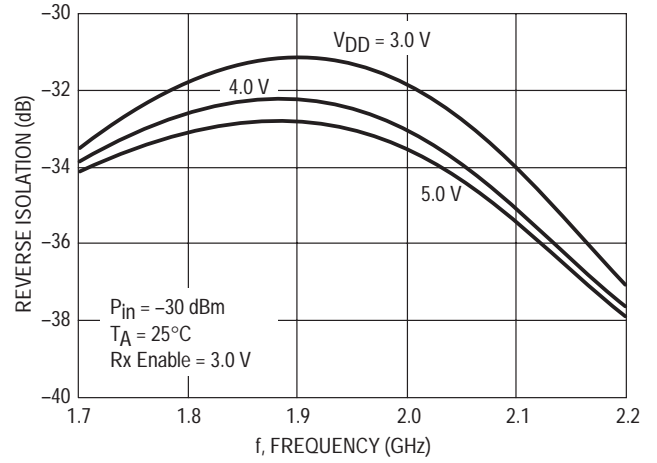


**Figure 6. Gain versus Frequency**



**Figure 7. Noise Figure versus Frequency**



**TYPICAL CHARACTERISTICS****Figure 8. Reverse Isolation versus Frequency****Figure 9. Reverse Isolation versus Frequency**

**Table 1. Scattering Parameters**  
(V<sub>DD</sub> = 3.0 V, T<sub>A</sub> = 25°C, Rx Enable = 3.0 V, 50 Ω System)

f MHz	S <sub>11</sub>		S <sub>21</sub>		S <sub>12</sub>		S <sub>22</sub>	
	S <sub>11</sub>	∠φ	S <sub>21</sub>	∠φ	S <sub>12</sub>	∠φ	S <sub>22</sub>	∠φ
1500	0.907	-42	2.91	153	0.012	87	0.793	-60
1530	0.913	-43	3.11	148	0.012	85	0.765	-62
1560	0.920	-44	3.32	144	0.013	83	0.735	-64
1590	0.927	-45	3.55	139	0.013	80	0.701	-66
1620	0.935	-46	3.78	135	0.013	76	0.665	-67
1650	0.943	-47	4.02	130	0.013	73	0.627	-69
1680	0.951	-48	4.26	125	0.013	70	0.586	-70
1710	0.959	-49	4.49	119	0.012	67	0.544	-70
1740	0.967	-50	4.72	114	0.012	63	0.500	-70
1770	0.975	-52	4.94	109	0.012	59	0.458	-70
1800	0.982	-53	5.17	104	0.011	56	0.418	-68
1830	0.988	-55	5.38	98	0.011	52	0.382	-65
1860	0.993	-56	5.58	93	0.011	48	0.351	-60
1890	0.997	-58	5.76	87	0.010	44	0.329	-54
1920	0.999	-59	5.92	82	0.009	40	0.317	-48
1950	1.002	-61	6.07	76	0.008	35	0.317	-40
1980	1.004	-62	6.19	71	0.008	30	0.327	-34
2010	1.004	-64	6.29	65	0.007	25	0.346	-28
2040	1.003	-65	6.37	60	0.006	19	0.371	-24
2070	1.002	-67	6.43	55	0.005	11	0.401	-21
2100	0.999	-68	6.50	50	0.004	2	0.433	-20
2130	0.996	-70	6.55	45	0.004	-10	0.467	-19
2160	0.994	-71	6.61	40	0.003	-29	0.499	-19
2190	0.991	-73	6.67	35	0.003	-52	0.530	-19
2220	0.989	-74	6.70	31	0.003	-80	0.560	-20
2250	0.984	-76	6.70	26	0.003	-100	0.589	-21
2280	0.981	-77	6.66	21	0.004	-113	0.615	-22
2310	0.975	-79	6.59	16	0.005	-122	0.639	-23
2340	0.968	-80	6.51	13	0.006	-130	0.661	-25
2370	0.960	-82	6.48	9	0.007	-135	0.681	-26
2400	0.953	-83	6.47	5	0.008	-140	0.698	-28
2430	0.944	-84	6.48	2	0.009	-145	0.714	-30
2460	0.937	-86	6.50	-2	0.011	-149	0.727	-31
2490	0.929	-87	6.52	-7	0.012	-154	0.739	-33
2520	0.922	-88	6.49	-11	0.013	-158	0.750	-34
2550	0.915	-90	6.43	-15	0.014	-161	0.758	-36
2580	0.908	-91	6.33	-19	0.015	-163	0.766	-38

**Table 2. Scattering Parameters**  
(V<sub>DD</sub> = 4.0 V, T<sub>A</sub> = 25°C, Rx Enable = 3.0 V, 50 Ω System)

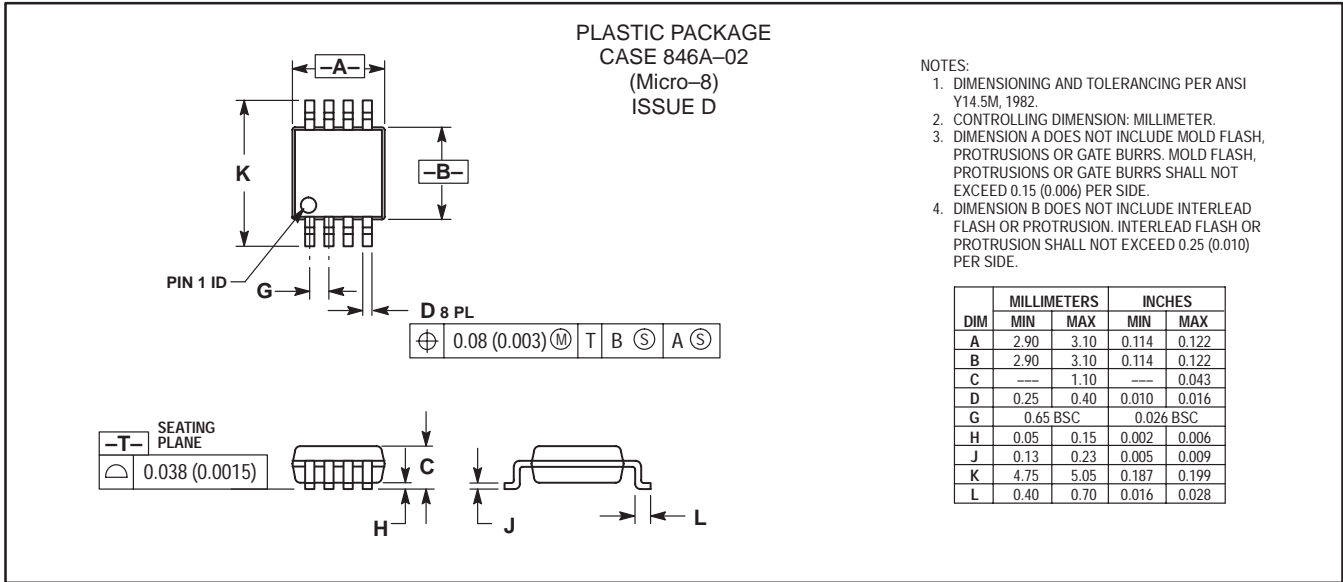
f MHz	S <sub>11</sub>		S <sub>21</sub>		S <sub>12</sub>		S <sub>22</sub>	
	S <sub>11</sub>	∠φ	S <sub>21</sub>	∠φ	S <sub>12</sub>	∠φ	S <sub>22</sub>	∠φ
1500	0.893	-42	3.20	151	0.012	87	0.797	-60
1530	0.899	-43	3.42	147	0.012	85	0.770	-62
1560	0.906	-44	3.65	143	0.012	82	0.740	-64
1590	0.914	-45	3.90	138	0.012	80	0.707	-65
1620	0.921	-46	4.15	134	0.013	77	0.671	-67
1650	0.929	-47	4.41	129	0.013	73	0.633	-68
1680	0.936	-48	4.67	124	0.013	70	0.593	-70
1710	0.945	-49	4.93	119	0.012	67	0.551	-70
1740	0.953	-50	5.18	113	0.012	63	0.507	-71
1770	0.960	-52	5.43	108	0.012	60	0.465	-70
1800	0.967	-53	5.66	103	0.011	57	0.424	-68
1830	0.973	-55	5.89	97	0.011	53	0.387	-66
1860	0.979	-56	6.11	92	0.011	50	0.355	-61
1890	0.982	-58	6.32	87	0.010	46	0.330	-56
1920	0.985	-59	6.51	81	0.009	43	0.317	-49
1950	0.987	-61	6.68	75	0.008	39	0.314	-42
1980	0.988	-62	6.81	70	0.008	32	0.322	-35
2010	0.989	-64	6.92	65	0.007	26	0.339	-29
2040	0.988	-65	7.02	60	0.006	20	0.364	-25
2070	0.986	-67	7.09	54	0.005	13	0.394	-22
2100	0.984	-68	7.17	49	0.005	4	0.425	-20
2130	0.980	-70	7.23	44	0.004	-7	0.459	-19
2160	0.978	-71	7.30	40	0.003	-21	0.491	-18
2190	0.975	-73	7.35	35	0.003	-39	0.524	-19
2220	0.972	-74	7.39	30	0.002	-69	0.554	-19
2250	0.968	-76	7.38	25	0.003	-93	0.584	-20
2280	0.964	-77	7.34	20	0.004	-109	0.611	-21
2310	0.958	-79	7.26	16	0.004	-118	0.635	-23
2340	0.950	-80	7.18	12	0.005	-126	0.658	-24
2370	0.942	-82	7.14	8	0.007	-133	0.678	-26
2400	0.934	-83	7.14	4	0.008	-138	0.695	-28
2430	0.927	-84	7.15	1	0.009	-145	0.712	-29
2460	0.920	-85	7.16	-3	0.010	-150	0.726	-31
2490	0.912	-87	7.17	-8	0.011	-154	0.738	-33
2520	0.905	-88	7.14	-12	0.012	-158	0.749	-34
2550	0.897	-89	7.07	-16	0.013	-161	0.758	-36
2580	0.891	-91	6.95	-20	0.014	-163	0.766	-38

**Table 3. Scattering Parameters**  
(V<sub>DD</sub> = 5.0 V, T<sub>A</sub> = 25°C, Rx Enable = 3.0 V, 50 Ω System)

f MHz	S <sub>11</sub>		S <sub>21</sub>		S <sub>12</sub>		S <sub>22</sub>	
	S <sub>11</sub>	∠φ	S <sub>21</sub>	∠φ	S <sub>12</sub>	∠φ	S <sub>22</sub>	∠φ
1500	0.876	-42	3.50	150	0.012	87	0.799	-59
1530	0.883	-43	3.73	146	0.012	85	0.773	-61
1560	0.891	-44	3.98	141	0.012	83	0.744	-63
1590	0.898	-45	4.25	137	0.012	80	0.712	-65
1620	0.906	-46	4.52	132	0.012	77	0.677	-67
1650	0.914	-47	4.80	127	0.012	74	0.640	-68
1680	0.921	-48	5.08	122	0.012	71	0.600	-69
1710	0.928	-49	5.36	117	0.012	67	0.559	-70
1740	0.936	-51	5.63	112	0.012	64	0.517	-70
1770	0.944	-52	5.90	107	0.012	60	0.475	-70
1800	0.950	-53	6.16	102	0.011	57	0.435	-69
1830	0.956	-55	6.41	96	0.011	54	0.397	-66
1860	0.961	-56	6.66	91	0.010	50	0.365	-62
1890	0.965	-58	6.89	85	0.010	47	0.339	-57
1920	0.967	-59	7.10	80	0.009	43	0.323	-51
1950	0.968	-61	7.29	74	0.009	39	0.318	-44
1980	0.969	-62	7.44	69	0.008	35	0.323	-37
2010	0.970	-64	7.56	64	0.007	29	0.338	-31
2040	0.969	-66	7.66	58	0.006	24	0.361	-26
2070	0.966	-67	7.75	53	0.006	18	0.389	-23
2100	0.963	-69	7.84	48	0.005	10	0.420	-21
2130	0.960	-70	7.91	43	0.004	0	0.453	-19
2160	0.957	-72	7.98	38	0.003	-15	0.485	-19
2190	0.954	-73	8.04	34	0.003	-34	0.517	-19
2220	0.951	-75	8.08	29	0.002	-59	0.547	-20
2250	0.946	-76	8.07	24	0.003	-83	0.576	-21
2280	0.942	-78	8.02	19	0.003	-104	0.603	-22
2310	0.936	-79	7.93	14	0.004	-116	0.629	-23
2340	0.928	-81	7.84	10	0.005	-125	0.652	-24
2370	0.920	-82	7.80	7	0.006	-132	0.672	-26
2400	0.912	-83	7.79	3	0.007	-138	0.690	-28
2430	0.904	-84	7.79	-1	0.008	-143	0.707	-29
2460	0.896	-86	7.81	-5	0.009	-148	0.720	-31
2490	0.889	-87	7.81	-9	0.010	-152	0.733	-33
2520	0.882	-88	7.78	-13	0.011	-155	0.744	-34
2550	0.874	-89	7.69	-17	0.012	-158	0.754	-36
2580	0.869	-91	7.56	-21	0.013	-161	0.762	-38



OUTLINE DIMENSIONS



Motorola reserves the right to make changes without further notice to any products herein. Motorola makes no warranty, representation or guarantee regarding the suitability of its products for any particular purpose, nor does Motorola assume any liability arising out of the application or use of any product or circuit, and specifically disclaims any and all liability, including without limitation consequential or incidental damages. "Typical" parameters which may be provided in Motorola data sheets and/or specifications can and do vary in different applications and actual performance may vary over time. All operating parameters, including "Typicals" must be validated for each customer application by customer's technical experts. Motorola does not convey any license under its patent rights nor the rights of others. Motorola products are not designed, intended, or authorized for use as components in systems intended for surgical implant into the body, or other applications intended to support or sustain life, or for any other application in which the failure of the Motorola product could create a situation where personal injury or death may occur. Should Buyer purchase or use Motorola products for any such unintended or unauthorized application, Buyer shall indemnify and hold Motorola and its officers, employees, subsidiaries, affiliates, and distributors harmless against all claims, costs, damages, and expenses, and reasonable attorney fees arising out of, directly or indirectly, any claim of personal injury or death associated with such unintended or unauthorized use, even if such claim alleges that Motorola was negligent regarding the design or manufacture of the part. Motorola and are registered trademarks of Motorola, Inc. Motorola, Inc. is an Equal Opportunity/Affirmative Action Employer.

Mfax is a trademark of Motorola, Inc.

**How to reach us:**

**USA/EUROPE/Locations Not Listed:** Motorola Literature Distribution;  
P.O. Box 5405, Denver, Colorado 80217. 1-303-675-2140 or 1-800-441-2447

**JAPAN:** Motorola Japan Ltd.; SPD, Strategic Planning Office, 141,  
4-32-1 Nishi-Gotanda, Shinagawa-ku, Tokyo, Japan. 81-3-5487-8488

**Customer Focus Center: 1-800-521-6274**

**Mfax™:** RMFAX0@email.sps.mot.com – TOUCHTONE 1-602-244-6609  
Motorola Fax Back System – US & Canada ONLY 1-800-774-1848  
– http://sps.motorola.com/mfax/

**ASIA/PACIFIC:** Motorola Semiconductors H.K. Ltd.; Silicon Harbour Centre,  
2, Dai King Street, Tai Po Industrial Estate, Tai Po, N.T., Hong Kong.  
852-26668334

**HOME PAGE:** <http://motorola.com/sps/>

ARCHIVED BY FREESCALE SEMICONDUCTOR, INC. 2005



**MOTOROLA**