

# KA741/E/I

# SINGLE OPERATIONAL AMPLIFIER

## SINGLE OPERATIONAL AMPLIFIERS

The KA741 series are general purpose operational amplifiers which feature improved performance over industry standards like the KA709. It is intended for a wide range of analog applications. The high gain and wide range of operating voltage provide superior performance in integrator, summing amplifier, and general feedback applications.

## FEATURES

- Short circuit protection
- Excellent temperature stability
- Internal frequency compensation
- High Input voltage range
- Null of offset

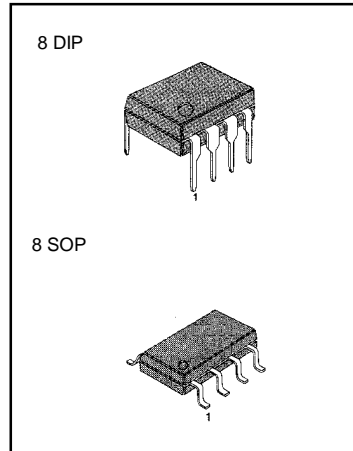

## BLOCK DIAGRAM

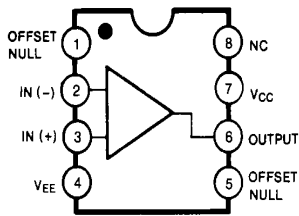

## ORDERING INFORMATION

Device	Package	Operating Temperature
KA741E KA741	8 DIP	0 ~ +70°C
KA741ED KA741D	8 SOP	
KA741I KA741EI	8 DIP	-40 ~ +85°C
KA7411ID KA741EID	8 SOP	

## SCHEMATIC DIAGRAM

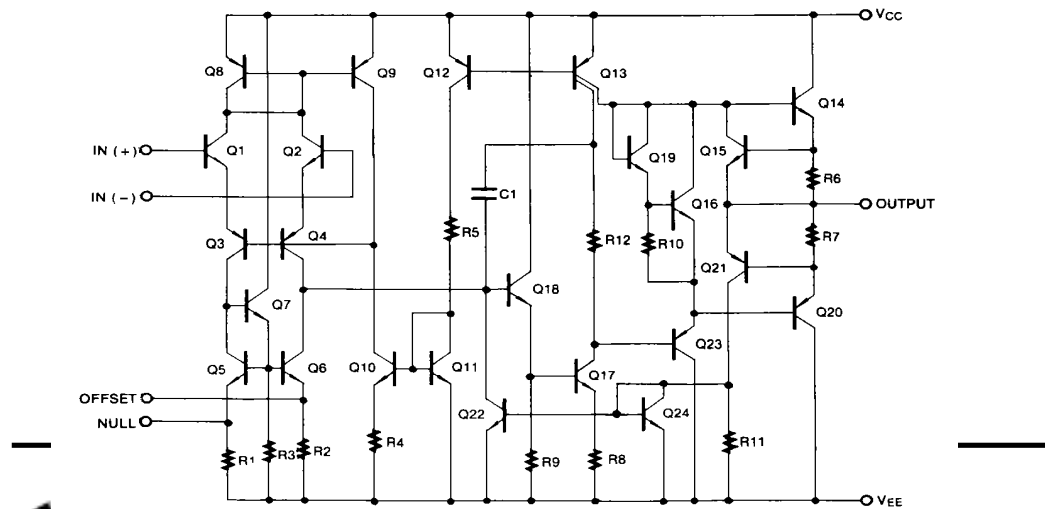

ABSOLUTE MAXIMUM RATINGS (T<sub>A</sub>=25 °C)

Characteristic	Symbol	KA741	KA741E	KA741I	Unit
Supply Voltage	V <sub>CC</sub>	± 18	± 22	± 18	V
Differential Input Voltage	V <sub>I(DIFF)</sub>	± 30	± 30	± 30	V
Input Voltage	V <sub>I</sub>	± 15	± 15	± 15	V
Output Short Circuit Duration		Indefinite	Indefinite	Indefinite	
Power Dissipation	P <sub>D</sub>	500	500	500	mW
Operating Temperature Range	T <sub>OPR</sub>	0 ~ + 70	0 ~ + 70	-40 ~ + 85	°C
Storage Temperature Range	T <sub>STG</sub>	-65 ~ + 150	-65 ~ + 150	-65 ~ + 150	°C

## ELECTRICAL CHARACTERISTICS

(V<sub>CC</sub> = 15V, V<sub>EE</sub> = - 15V, T<sub>A</sub> = 25 °C, unless otherwise specified)

Characteristic	Symbol	Test Conditions	KA741E			KA741I/KA741I			Unit
			Min	Typ	Max	Min	Typ	Max	
Input Offset Voltage	V <sub>IO</sub>	R <sub>S</sub> ≤ 10KΩ					2.0	6.0	mV
		R <sub>S</sub> ≤ 50Ω		0.8	3.0				
Input Offset Voltage Adjustment Range	V <sub>IO(R)</sub>	V <sub>CC</sub> = ± 20V	± 10				± 15		mV
Input Offset Current	I <sub>IO</sub>			3.0	30		20	200	nA
Input Bias Current	I <sub>BIAS</sub>			30	80		80	500	nA
Input Resistance	R <sub>I</sub>	V <sub>CC</sub> = ± 20V	1.0	6.0		0.3	2.0		MΩ
Input Voltage Range	V <sub>I(R)</sub>		± 12	± 13		± 12	± 13		V
Large Signal Voltage Gain	G <sub>V</sub>	R <sub>L</sub> ≥ 2KΩ	V <sub>CC</sub> = ± 20V, V <sub>O(P,P)</sub> = ± 15V	50					V/mV
			V <sub>CC</sub> = ± 15V, V <sub>O(P,P)</sub> = ± 10V				20	200	
Output Short Circuit Current	I <sub>SC</sub>		10	25	35		25		mA
Output Voltage Swing	V <sub>O(P,P)</sub>	V <sub>CC</sub> = ± 20V	R <sub>L</sub> ≥ 10KΩ	± 16					V
			R <sub>L</sub> ≥ 10KΩ	± 15					
		V <sub>CC</sub> = ± 15V	R <sub>L</sub> ≥ 10KΩ				± 12	± 14	
			R <sub>L</sub> ≥ 10KΩ				± 10	± 13	
Common Mode Rejection Ratio	CMRR	R <sub>S</sub> ≤ 10KΩ, V <sub>CM</sub> = ± 12V				70	90		dB
		R <sub>S</sub> ≤ 50KΩ, V <sub>CM</sub> = ± 12V	80	95					
Power Supply Rejection Ratio	PSRR	V <sub>CC</sub> = ± 15V to V <sub>CC</sub> = ± 15V R <sub>S</sub> ≤ 50Ω	86	96					dB
		V <sub>CC</sub> = ± 15V to V <sub>CC</sub> = ± 15V							
		R <sub>S</sub> ≤ 10KΩ				77	96		

## ELECTRICAL CHARACTERISTICS (Continued)

Characteristic		Symbol	Test Conditions	KA741E			KA741/KA741I			Unit
				Min	Typ	Max	Min	Typ	Max	
Transient Response	Rise Time	$t_r$	Unity Gain		0.25	0.8		0.3		$\mu$ s
	Overshoot	OS			6.0	20		10		%
Bandwidth		BW		0.43	1.5					MHz
Slew Rate		SR	Unity Gain	0.3	0.7		0.5			V/ $\mu$ s
Supply Current		$I_{CC}$	$R_L = \infty \Omega$				1.5	2.8		mA
Power Consumption		$P_C$	$V_{CC} = \pm 20V$		80	150				mW
			$V_{CC} = \pm 15V$				50	85		

## ELECTRICAL CHARACTERISTICS

( $-40^\circ\text{C} \leq T_A \leq 85^\circ\text{C}$  for the KA7411,  $0 \leq T_A \leq 70^\circ\text{C}$  for the KA741 and KA741E.  $V_{CC} = \pm 15V$ , unless otherwise specified)

Characteristic		Symbol	Test Conditions	KA741E			KA741/KA741I			Unit
				Min	Typ	Max	Min	Typ	Max	
Input Offset Voltage		$V_{IO}$	$R_S \leq 50\Omega$			4.0				mV
			$R_S \leq 10K\Omega$						7.5	
Input Offset Voltage Drift		$\Delta V_{IO}/\Delta T$		15						$\mu$ V/ $^\circ\text{C}$
Input Offset Current		$I_{IO}$			70			300		nA
Input Offset Current Drift		$\Delta I_{IO}/\Delta T$			0.5					nA/ $^\circ\text{C}$
Input Bias Current		$I_{BIAS}$			0.21			0.8		$\mu$ A
Input Resistance		$R_I$	$V_{CC} = \pm 20V$	0.5						M $\Omega$
Input Voltage Range		$V_{I(R)}$		$\pm 12$	$\pm 13$		$\pm 12$	$\pm 13$		V
Output Voltage Swing		$V_{O(P,P)}$	$V_{CC} = \pm 20V$	$R_S \geq 10K\Omega$	$\pm 16$					V
				$R_S \geq 2K\Omega$	$\pm 15$					
		$V_{CC} = \pm 15V$	$R_S \geq 10K\Omega$				$\pm 12$	$\pm 14$		
			$R_S \geq 2K\Omega$				$\pm 10$	$\pm 13$		
Output Short Circuit Current		$I_{SC}$		10		40	10		40	mA
Common Mode Rejection Ratio		CMRR	$R_S \leq 10K\Omega$ , $V_{CM} = \pm 12V$				70	90		dB
			$R_S \leq 50K\Omega$ , $V_{CM} = \pm 12V$	80	95					
Power Supply Rejection Ratio		PSRR	$V_{CC} = \pm 20V$	$R_S \leq 50\Omega$	86	96				dB
			to $\pm 5V$	$R_S \leq 10K\Omega$			77	96		
Large Signal Voltage Gain		$G_V$	$R_S \geq 2K\Omega$	$V_{CC} = \pm 20V$ , $V_{O(P,P)} = \pm 15V$	32					V/mV
				$V_{CC} = \pm 15V$ , $V_{O(P,P)} = \pm 10V$			15			
				$V_{CC} = \pm 15V$ , $V_{O(P,P)} = \pm 2V$	10					

TYPICAL PERFORMANCE CHARACTERISTICS

Fig. 7 OUTPUT RESISTANCE vs FREQUENCY

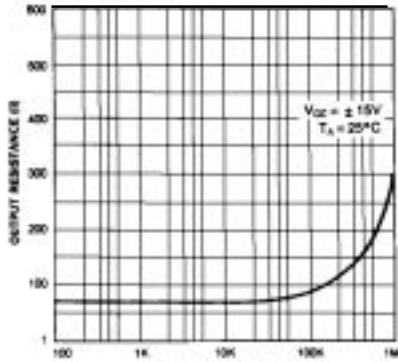

Fig. 8 INPUT RESISTANCE AND INPUT CAPACITANCE vs FREQUENCY

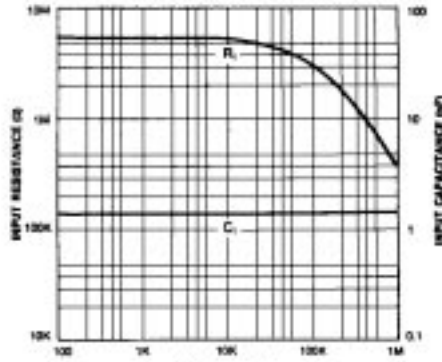

Fig. 9 INPUT BIAS CURRENT vs AMBIENT TEMPERATURE

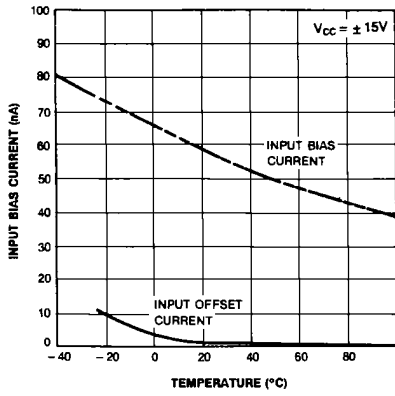

Fig. 10 POWER CONSUMPTION vs AMBIENT TEMPERATURE

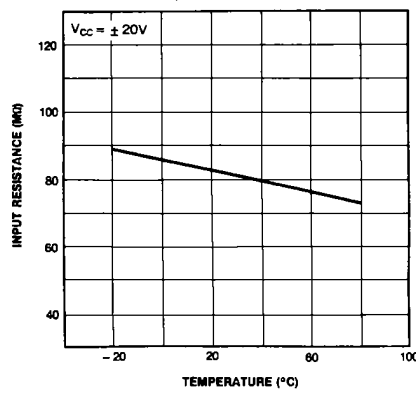

Fig. 11 INPUT OFFSET CURRENT vs AMBIENT TEMPERATURE

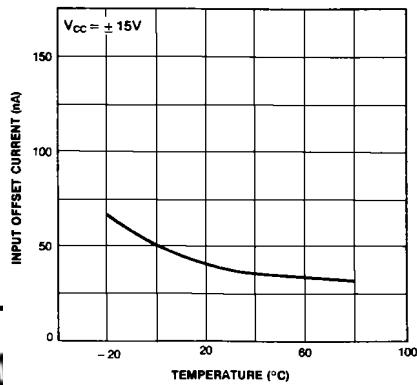

Fig. 12 INPUT RESISTANCE vs AMBIENT TEMPERATURE

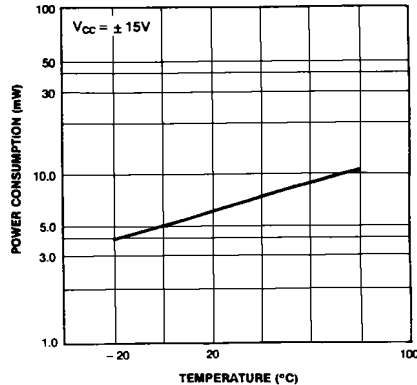

Fig. 13 NORMALIZED DC PARAMETERS vs AMBIENT TEMPERATURE

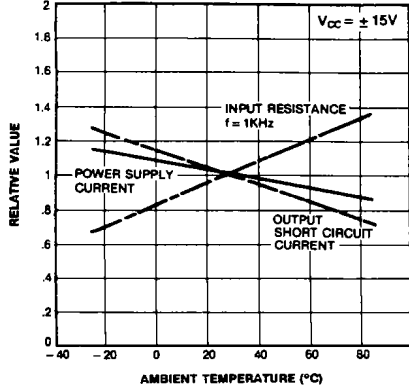

Fig. 14 FREQUENCY CHARACTERISTICS vs AMBIENT TEMPERATURE

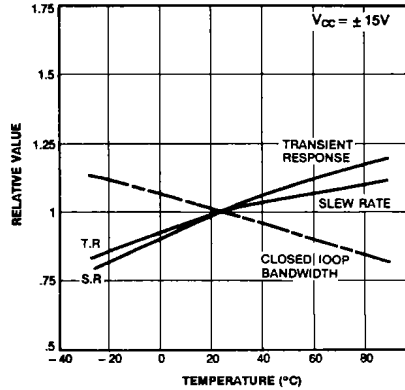

Fig. 15 FREQUENCY CHARACTERISTICS vs SUPPLY VOLTAGE

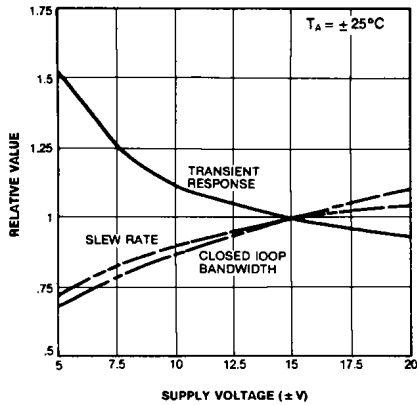

Fig. 16 OUTPUT SHORT CIRCUIT CURRENT vs AMBIENT TEMPERATURE

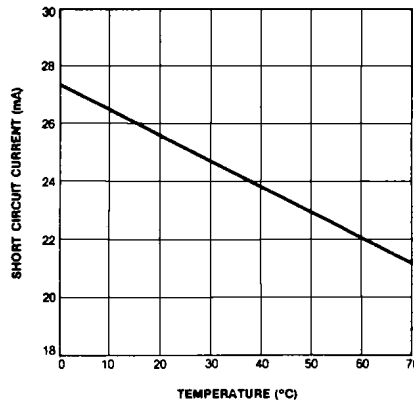

Fig. 17 TRANSIENT RESPONSE

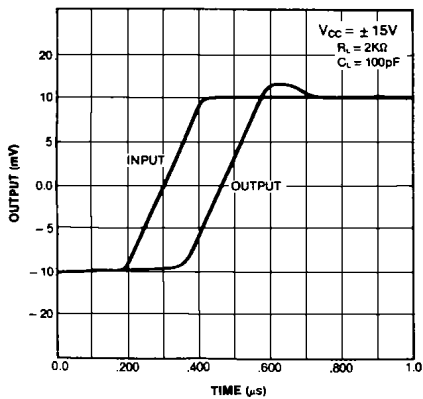

Fig. 18 COMMON-MODE REJECTION RATIO vs FREQUENCY

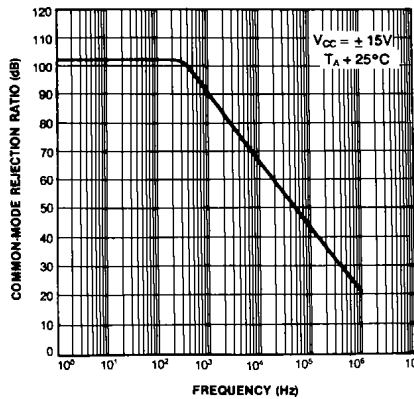

Fig. 18 VOLTAGE FOLLOWER LARGE SIGNAL PULSE RESPONSE

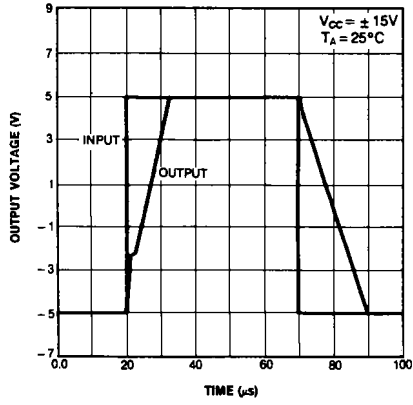
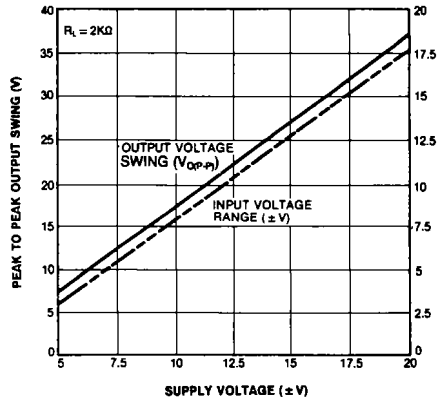
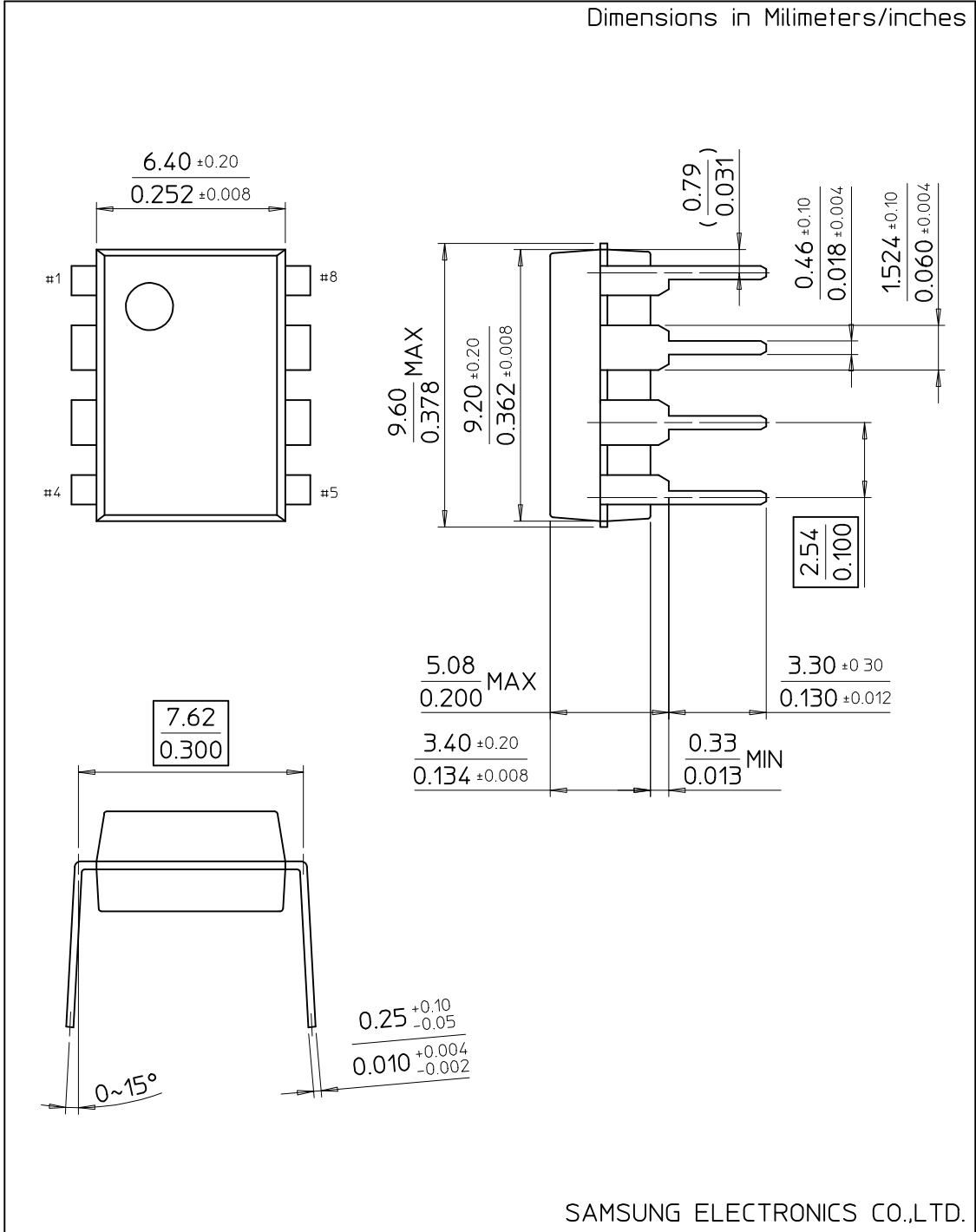

Fig. 19 OUTPUT SWING AND INPUT RANGE vs SUPPLY VOLTAGE



# 8-DIP-300

Dimensions in Millimeters/inches



SAMSUNG ELECTRONICS CO.,LTD.

# 8-SOP-225

Dimensions in Millimeters/inches

