

KA3511BS

Intelligent Voltage Mode PWM IC

Features

- Complete PWM control and house keeping circuitry
- Few external components
- Precision voltage reference trimmed to 2%
- Dual output for push-pull operation
- Each output TR for 200mA sink current
- Variable duty cycle by dead time control
- Soft start capability by using dead time control
- Double pulse suppression logic
- Over voltage protection for 3.3V / 5V / 12V
- Under voltage protection for 3.3V / 5V / 12V
- One more external input for various protection (PT)
- Remote on/off control function (PS-ON)
- Latch function controlled by remote and protection input
- Power good signal generator with hysteresis

Precision reference section

The reference voltage trimmed to $\pm 2\%$
($4.9V \leq V_{ref} \leq 5.1V$)

PG (Power good signal generator) section

Power good signal generator is to monitor the voltage level of power supply for safe operation of a microprocessor. KA3511BS requires few external components to accomplish a complete housekeeping circuits for SMPS.

Description

The KA3511BS is a fixed frequency improved performance pulse width modulation control circuit with complete housekeeping circuitry for use in the secondary side of SMPS (Switched mode power supply). It contains various functions, which are precision voltage reference, over voltage protection, under voltage protection, remote on/off control, power good signal generator and etc.

OVP (Over voltage protection) section

It has OVP functions for +3.3V,+5V,+12V and PT outputs. The circuit is made up of a comparator with four detecting inputs and without hysteresis voltage. Especially, PT (Pin18) is prepared for an extra OVP input or another protection signal.

UVP (Under voltage protection) section

It also has UVP functions for +3.3V, +5V, +12V outputs. The block is made up of a comparator with three detecting inputs and without hysteresis voltage.

Remote on/off section

Remote on/off section is used to control SMPS externally. If a high signal is supplied to the remote on/off input, PWM signal becomes a high state and all secondary outputs are grounded. The remote on/off signal is transferred with some on-delay and off-delay time of 8ms, 24ms respectively.



Pin Definition : KA3511BS

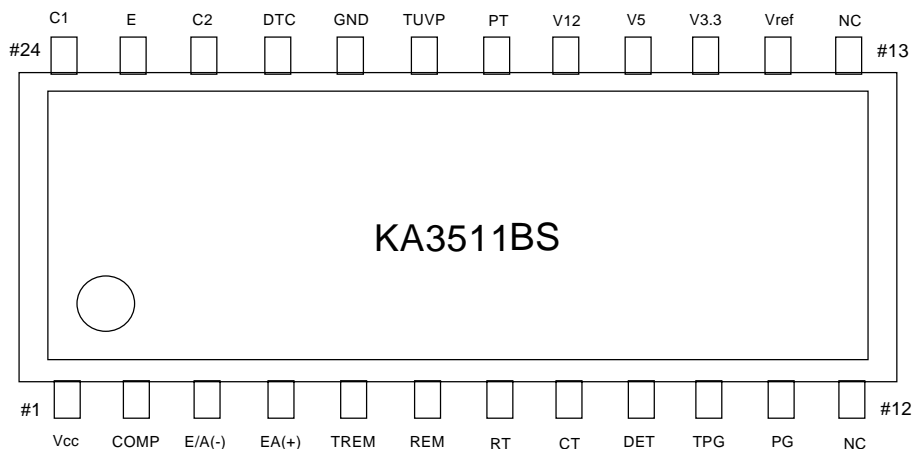

| Pin Number | Pin Name | I/O | Pin Function | Pin Number | Pin Name | I/O | Pin Function Description |
|------------|----------|-----|-----------------------------|------------|----------|-----|--------------------------|
| 1 | VCC | I | Supply voltage | 13 | NC | - | NC |
| 2 | COMP | O | E/A output | 14 | Vref | O | Precision reference VTG |
| 3 | E/A(-) | I | E/A (-) input | 15 | V3.3 | I | OVP, UVP input for 3.3V |
| 4 | E/A(+) | I | E/A (+) input | 16 | V5 | I | OVP, UVP input for 5V |
| 5 | TREM | - | Remote on/off delay | 17 | V12 | I | OVP, UVP input for 12V |
| 6 | REM | I | Remote on/off input | 18 | PT | I | Extra protection input |
| 7 | RT | - | Oscillation freq. setting R | 19 | TUVp | - | UVP delay |
| 8 | CT | - | Oscillation freq. setting C | 20 | GND | - | Signal ground |
| 9 | DET | I | Detect input | 21 | DTC | I | Deadtime control input |
| 10 | TPG | - | PG delay | 22 | C2 | O | Output 2 |
| 11 | PG | O | Power good signal output | 23 | E | - | Power ground |
| 12 | NC | - | NC | 24 | C1 | O | Output 1 |

| Pin Number | Pin Name | Pin Function Description |
|------------|----------|--|
| 1 | VCC | Supply voltage. Operating range is 10V~30V. $V_{CC}=20V$, $T_a=25^{\circ}C$ at test. |
| 2 | COMP | Error amplifier output. It is connected to non-inverting input of pulse width modulator comparator. |
| 3 | E/A(-) | Error amplifier inverting input. Its reference voltage is always 1.25V. |
| 4 | E/A(+) | Error amplifier non-inverting input feedback voltage. This pin may be used to sense power supply output voltage. |
| 5 | TREM | Remote on/off delay. $T_{on}/T_{off}=8ms/24ms$ (Typ.) with $C=0.1\mu F$. Its high/low threshold voltage is 1.8V/0.6V. |
| 6 | REM | Remote on/off input. It is TTL operation and its threshold voltage is 1.4V. Voltage at this pin can reach normal 4.6V, with absolutely maximum voltage, 5.25V. If REM = "Low", PWM = "Low". That means the main SMPS is operational. When REM = "High", then PWM = "High" and the main SMPS is turned-off. |
| 7 | RT | Oscillation frequency setting R. (Test Condition $R_T=10k\Omega$) |
| 8 | CT | Oscillation frequency setting C. (Test Condition $C_T=0.01\mu F$) |
| 9 | DET | Under voltage detection pin. Its threshold voltage is 1.25V Typ. |
| 10 | TPG | PG delay. $T_d=250ms$ (Typ) with $C_{PG}=2.2\mu F$. The high/low threshold voltage are 1.8V/0.6V and the voltage of Pin10 is clamped at 2.9V for noise margin. |
| 11 | PG | Power good output signal. PG = "High" means that the power is "Good" for operation and PG = "Low" means "Power fail". |
| 14 | Vref | Precision voltage reference trimmed to 2%. (Typical Value = 5.03V) |
| 15 | V3.3 | OVP, UVP input for output 3.3V. (Typical Value = 4.1V/2.3V) |
| 16 | V5 | OVP, UVP input for output 5V. (Typical Value = 6.2V/4.0V) |
| 17 | V12 | OVP, UVP input for output 12V. (Typical Value = 14.2V/10V) |
| 18 | PT | This is prepared for an extra OVP input or another protection signal. (Typical Value = 1.25V) |
| 19 | TUVP | Timing pin for under voltage protection blank-out time. Its threshold voltage is 1.8V and clamped at 2.9V after full charging. Target of delay time is 250ms and it is realized through external ($C=2.2\mu F$). |
| 20 | GND | Signal ground. |
| 21 | DTC | Deadtime control input. The dead-time control comparator has an effective 120mV input offset which limits the minimum output dead time. Dead time may be imposed on the output by setting the dead time control input to a fixed voltage, ranging between 0V to 3.3V. |
| 22 | C2 | Output drive pin for push-pull operation. |
| 23 | E | Power ground. |
| 24 | C1 | Output drive pin for push-pull operation. |

Electrical Characteristics ($V_{CC}=20V$, $T_a=25^\circ C$)

| Parameter | Symbol | Condition | Min. | Typ. | Max. | Unit |
|--|---------------------------|--|------|------|------|------|
| REFERENCE SECTION | | | | | | |
| Reference output voltage | Vref | Iref=1mA | 4.9 | 5 | 5.1 | V |
| Line regulation | $\Delta V_{ref.LINE}$ | $10V \leq V_{CC} \leq 30V$ | - | 2.0 | 25 | mV |
| Load regulation | $\Delta V_{ref.LOAD}$ | $1mA \leq I_{ref} \leq 10mA$ | - | 1.0 | 15 | mV |
| Temperature coefficient of Vref ⁽¹⁾ | $\Delta V_{ref}/\Delta T$ | $-25^\circ C \leq T_a \leq 85^\circ C$ | - | 0.01 | - | %/°C |
| Short-circuit output current | ISC | Vref=0 | 15 | 35 | 75 | mA |
| OSCILLATOR SECTION | | | | | | |
| Oscillation frequency | fosc | $C_T=0.01\mu F$, $R_T=12k$ | - | 10 | - | kHz |
| Frequency change with temperature ⁽¹⁾ | fosc/T | $C_T=0.01\mu F$, $R_T=12k$ | - | 2 | - | % |
| DEAD TIME CONTROL SECTION | | | | | | |
| Input bias current | I _{B(DT)} | - | - | -2.0 | -10 | μA |
| Maximum duty voltage | DCMAX | Pin19 (DTC)=0V | 45 | 48 | 50 | % |
| Input threshold voltage | V _{TH(DT)} | Zero Duty Cycle | - | 3.0 | 3.3 | V |
| | | Max. Duty Cycle | 0 | - | - | |
| ERROR AMP SECTION | | | | | | |
| Inverting reference voltage | Vref(EA) | - | 1.20 | 1.25 | 1.30 | V |
| Input bias current | I _{B(EA)} | V _{COMP} =2.5V | - | -0.1 | -1.0 | μA |
| Open-loop voltage gain ⁽¹⁾ | G _{VO} | $0.5V \leq V_{COMP} \leq 3.5V$ | 70 | 95 | - | dB |
| Unit-gain bandwidth ⁽¹⁾ | BW | - | - | 650 | - | kHz |
| Output sink current | I _{SINK} | V _{COMP} =0.7V | 0.3 | 0.9 | - | mA |
| Output source current | I _{SOURCE} | V _{COMP} =3.5V | -2.0 | -4.0 | - | mA |
| PWM COMPARATOR SECTION | | | | | | |
| Input threshold voltage | V _{TH(PWM)} | Zero Duty Cycle | - | 4 | 4.5 | V |
| OUTPUT SECTION | | | | | | |
| Output saturation voltage | V _{CE(SAT)} | I _C =200mA | - | 1.1 | 1.3 | V |
| Collector off-state current | I _{C(off)} | V _{CC} =V _C =30V, V _E =0V | - | 2 | 100 | μA |
| Rising time | T _R | - | - | 100 | 200 | ns |
| Falling time | T _F | - | - | 50 | 200 | ns |
| PROTECTION SECTION | | | | | | |
| Over voltage protection for 3.3V | VOVP1 | - | 3.8 | 4.1 | 4.3 | V |

Electrical Characteristics (continued)

| Parameter | Symbol | Condition | Min. | Typ. | Max. | Unit |
|---|------------------------|--------------------------|------|------|------|------|
| Over voltage protection for 5V | VOVP2 | - | 5.8 | 6.2 | 6.6 | V |
| Over voltage protection for 12V | VOVP3 | - | 13.5 | 14.2 | 15.0 | V |
| Input threshold voltage for PT | VPT | - | 1.20 | 1.25 | 1.30 | V |
| Under voltage protection for 3.3V | VUVP1 | - | 2.1 | 2.3 | 2.5 | V |
| Under voltage protection for 5V | VUVP2 | - | 3.7 | 4.0 | 4.3 | V |
| Under voltage protection for 12V | VUVP3 | - | 9.2 | 10 | 10.8 | V |
| Charging current for UVP delay | ICHG.UVP | C=2.2uF, VTH=1.8V | -10 | -15 | -23 | uA |
| UVP Delay Time | TD.UVP | C=2.2uF | 100 | 260 | 500 | ms |
| REMOTE ON/OFF SECTION | | | | | | |
| REM on input voltage | VREMH | I _{REM} =-200uA | 2.0 | - | - | V |
| REM off input voltage | VREML | - | - | - | 0.8 | V |
| REM off input bias voltage | I _{REML} | V _{REM} =0.4V | - | - | -1.6 | mA |
| REM on open voltage | V _{REM(OPEN)} | - | 2.0 | - | 5.25 | V |
| REM on delay time | T _{on} | C=0.1uF | 4 | 8 | 14 | ms |
| REM off delay time | T _{off} | C=0.1uF | 16 | 24 | 34 | ms |
| REMOTE ON/OFF SECTION ⁽²⁾ | | | | | | |
| Detecting input voltage | V _{IN(DET)} | - | 1.20 | 1.25 | 1.30 | V |
| Detecting V5 voltage | V _{5(DET)} | - | 4.1 | 4.3 | 4.5 | V |
| Hysteresis voltage 1 | HY1 | COMP1, 2 | 10 | 40 | 80 | mV |
| Hysteresis voltage 2 | HY2 | COMP3 | 0.6 | 1.2 | - | V |
| PG output load resistor | R _{PG} | - | 0.5 | 1 | 2 | kΩ |
| Charging current for PG delay | ICHG.PG | C=2.2uF, VTH=1.8V | -10 | -15 | -23 | uA |
| PG delay time | T _{D.PG} | C=2.2uF | 100 | 260 | 500 | ms |
| PG output saturation voltage | V _{SAT(PG)} | I _{PG} =10mA | - | 0.2 | 0.4 | V |
| TOTAL DEVICE | | | | | | |
| Standby supply current | I _{CC} | - | - | 10 | 20 | mA |

Note:

1. These Parameters, although guaranteed over their recommended operating conditions are not 100% tested in production.
2. REM on delay time (Pin6 REM: "L" → "H"),
REM off delay time (Pin6 REM: "H" → "L")

Application Informations

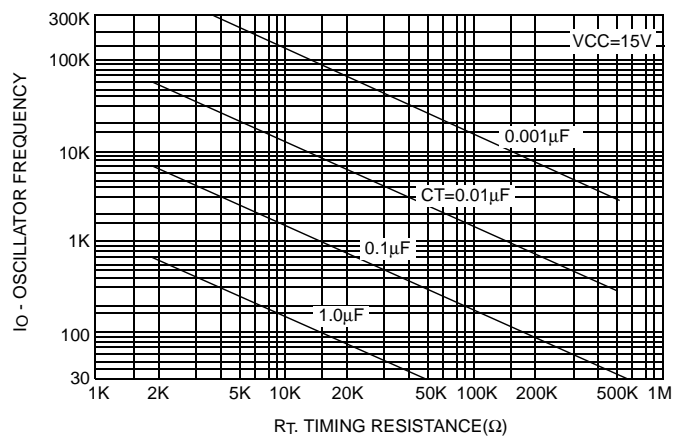

Figure 1. Oscillator Frequency vs. Timing Resistance

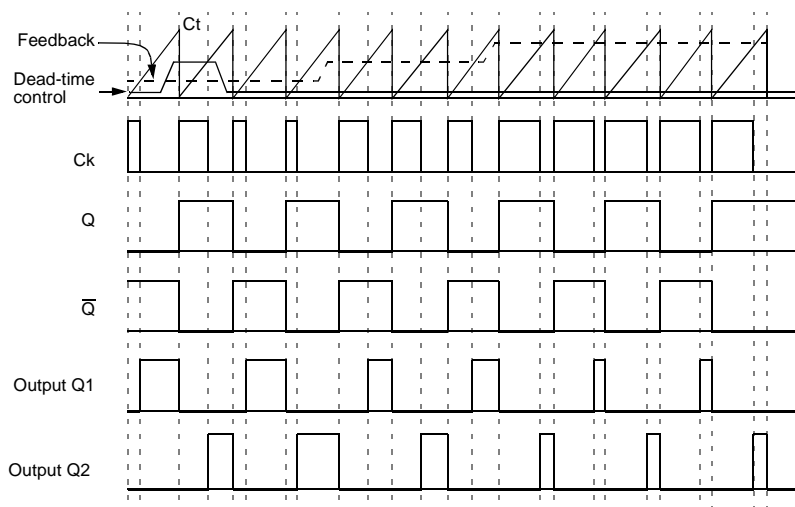
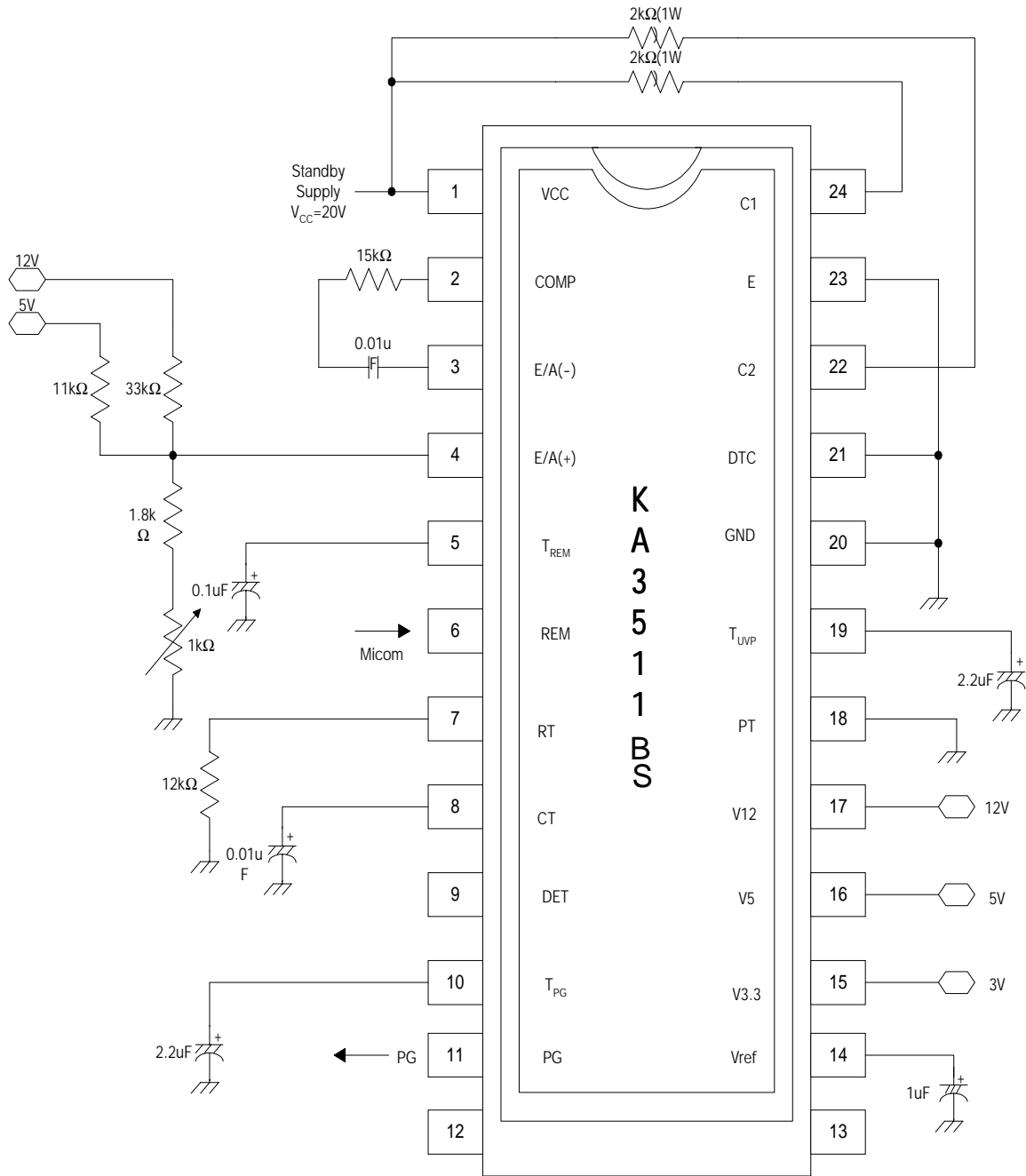

Figure 2. Operating Waveform

Housekeeping Circuit



Note :

The KA3511BS requires few external components to accomplish a complete housekeeping circuits for SMPS.

Typical Characteristics

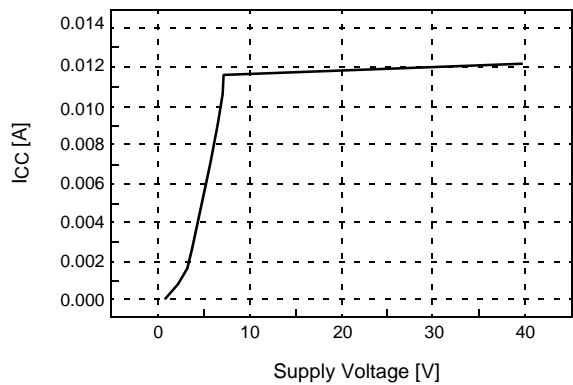

Figure 3. Vcc-Icc

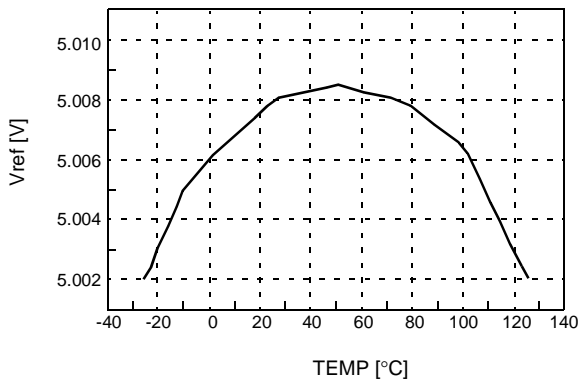

Figure 4. Bandgap Reference Voltage

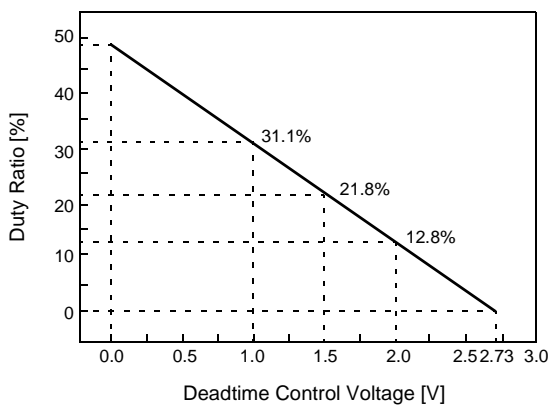

Figure 5. PIN19(Dead Time Control Voltage)-Duty Cycle

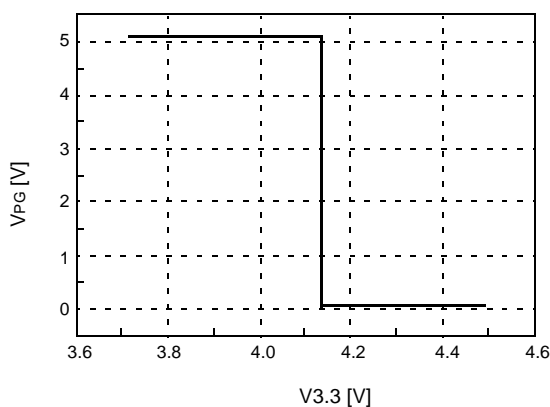

Figure 6. OVP for 3.3V

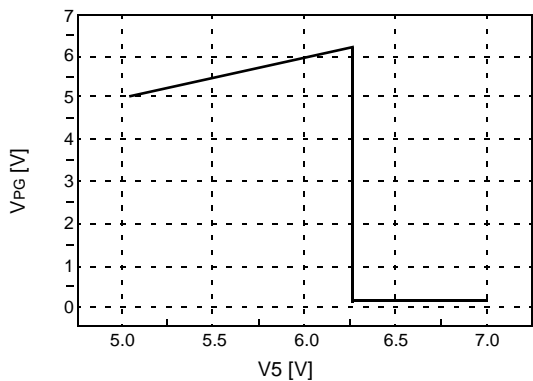

Figure 7. OVP for 5V

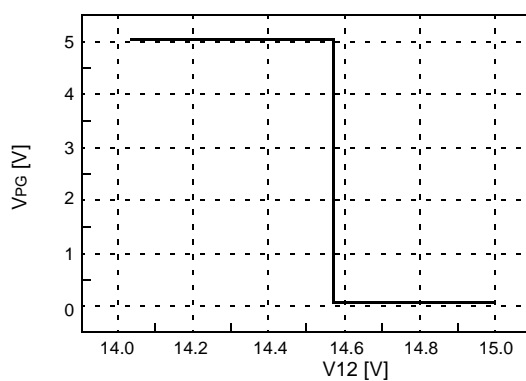

Figure 8. OVP for 12V

Typical Characteristics (Continued)

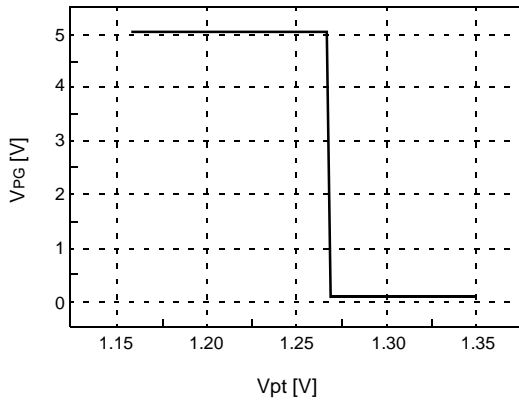

Figure 9. OVP for PT

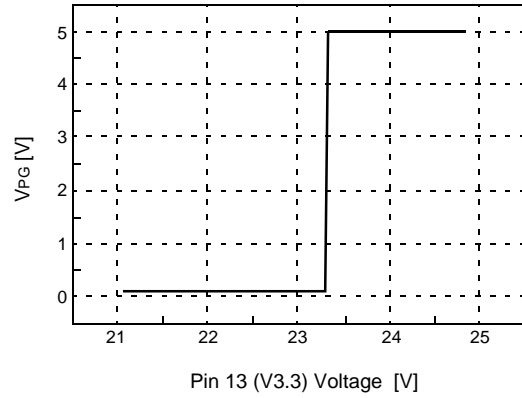

Figure 10. UVP for 3.3V

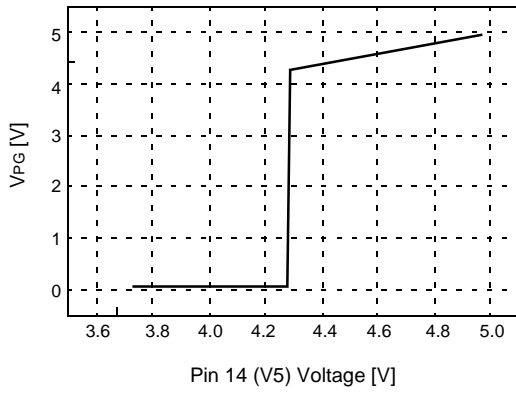

Figure 11 . UVP for 5V

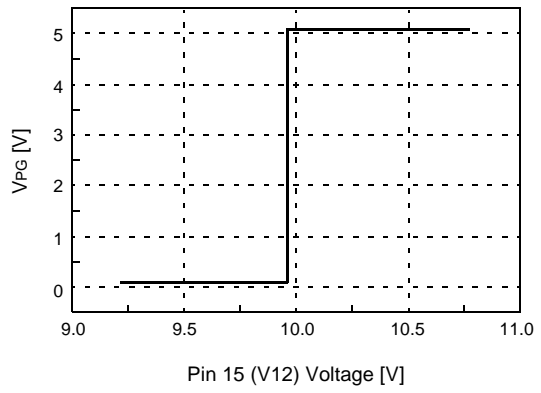

Figure 12 . UVP for 12V

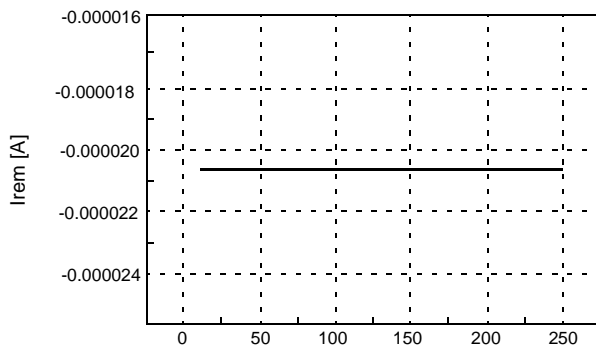

Figure 13 . Remote ON Charging Current

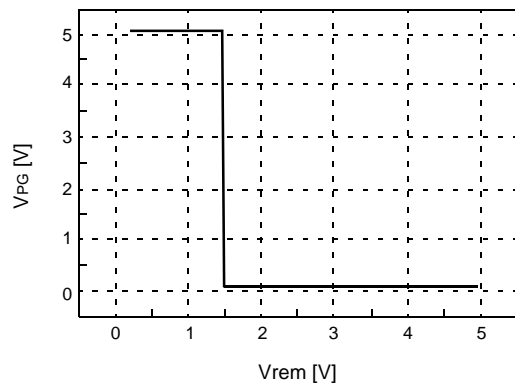

Figure 14 . REM ON/OFF V_{th}

Typical Characteristics (Continued)

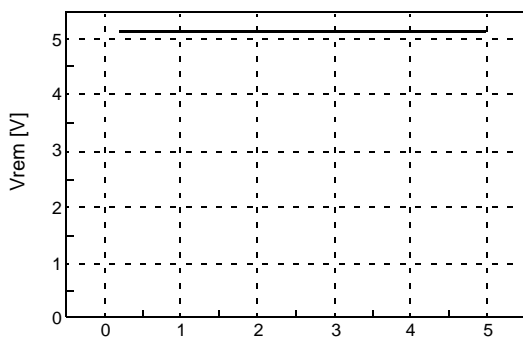

Figure 15. Remote ON Open Voltage

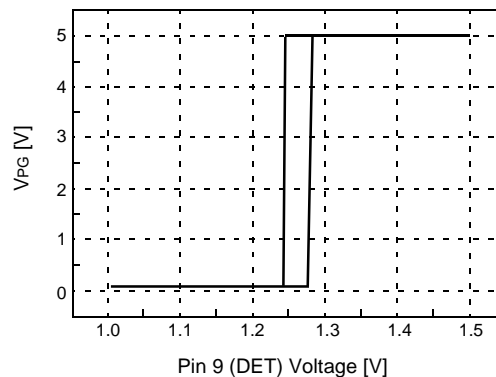

Figure 16. Detecting VCC Voltage (DET)

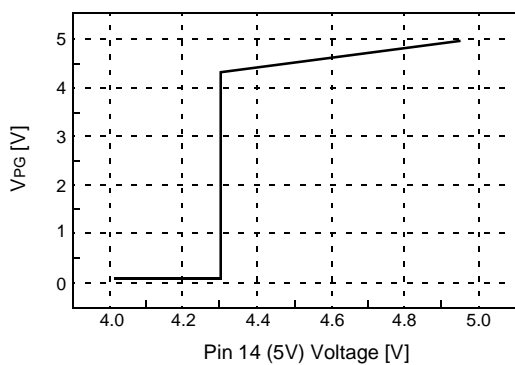

Figure 17. Detecting V5 Voltage

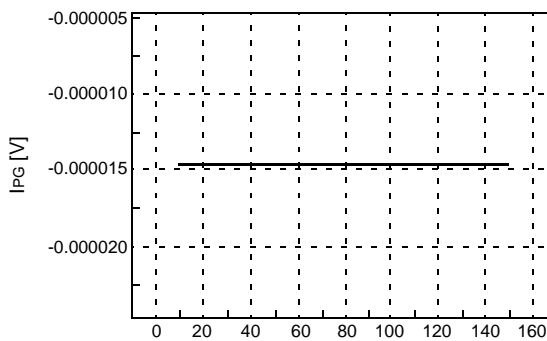

Figure 18. Charging Current for PG

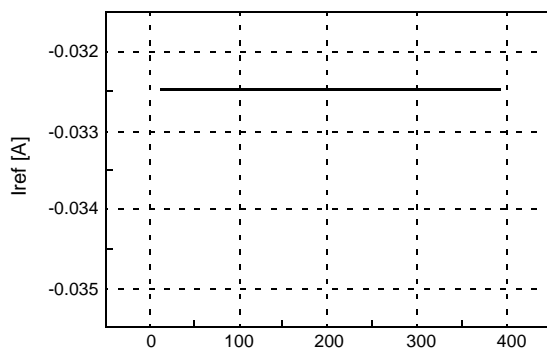

Figure 19. Short Circuit Current

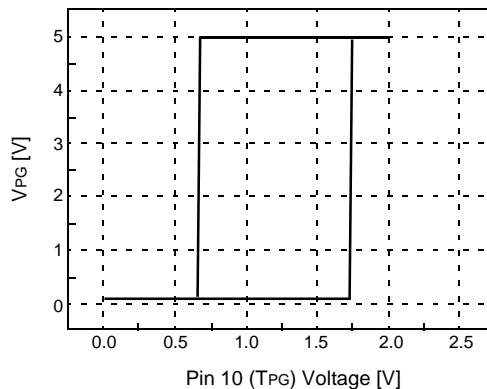

Figure 20. Hysteresis Voltage 2

Typical Characteristics (Continued)

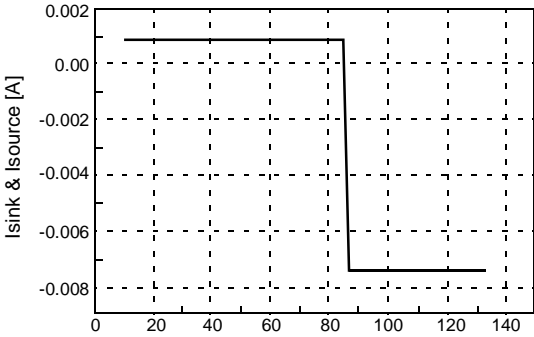

Figure 21. Error Amp Sink Current

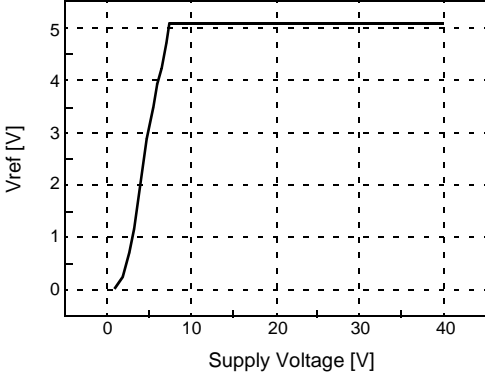
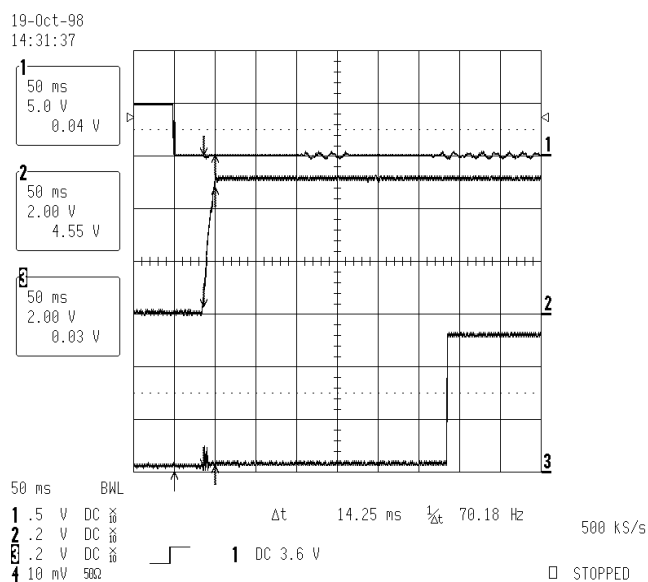

Figure 22. Reference Voltage

Experimental Result



CH1 : PS-ON
CH2 : +5Vdc Output
CH3 : PG Signal

Figure 23. Rising Time of +5Vdc Output Voltage

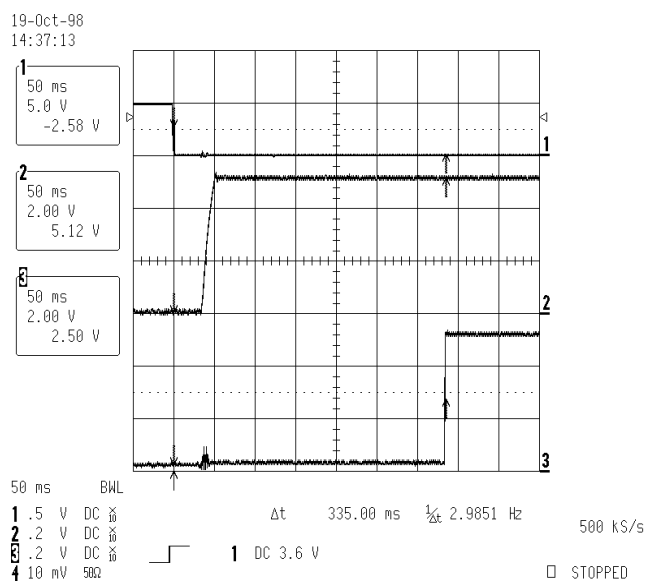

CH1 : PS-ON
CH2 : +5Vdc Output
CH3 : PG Signal

Figure 24. PG Signal Delay Time

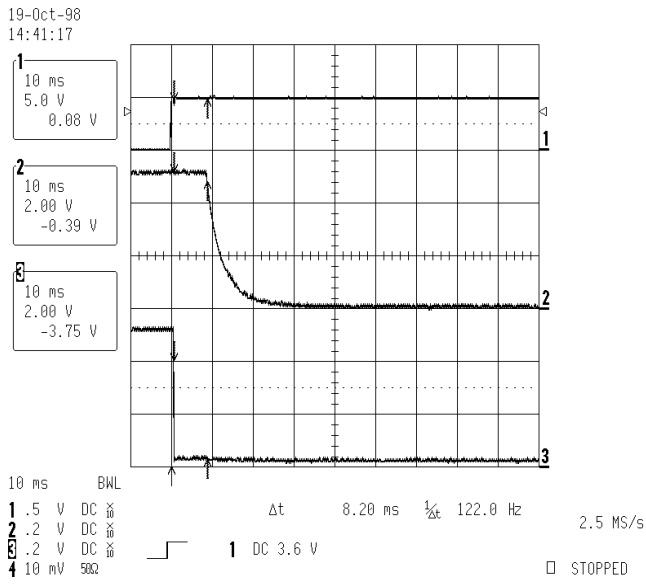

CH1 : PS-ON
CH2 : +5Vdc Output
CH3 : PG Signal

Figure 25. Power Down Warning

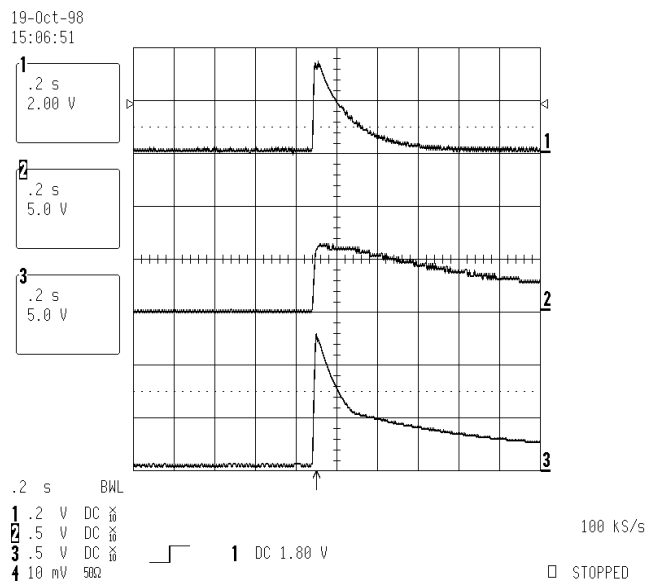

CH1 : +3.3Vdc Output
CH2 : +5Vdc Output
CH3 : +12Vdc Output

Figure 26. No Load Protection

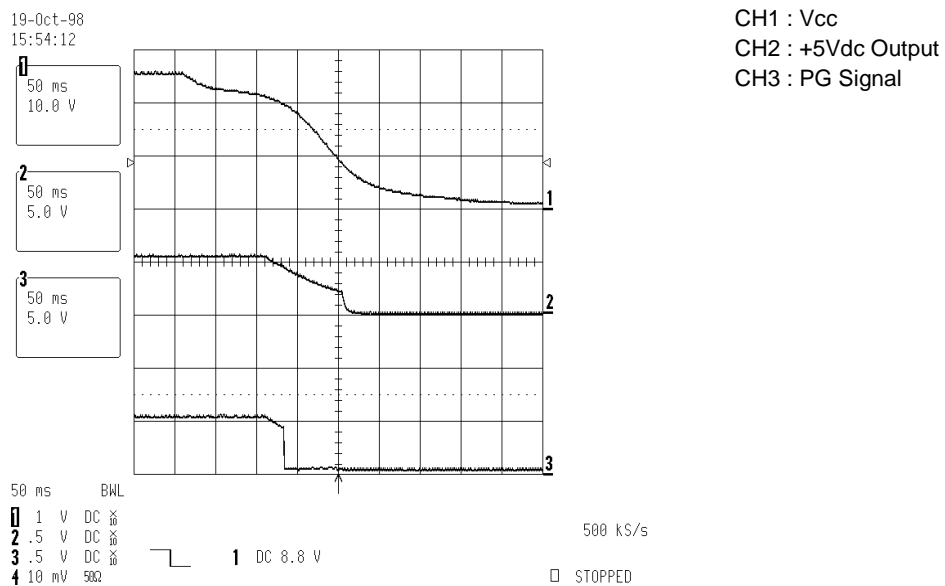

Figure 27. Vcc, +5Vdc Output vs. PG Signal (High)

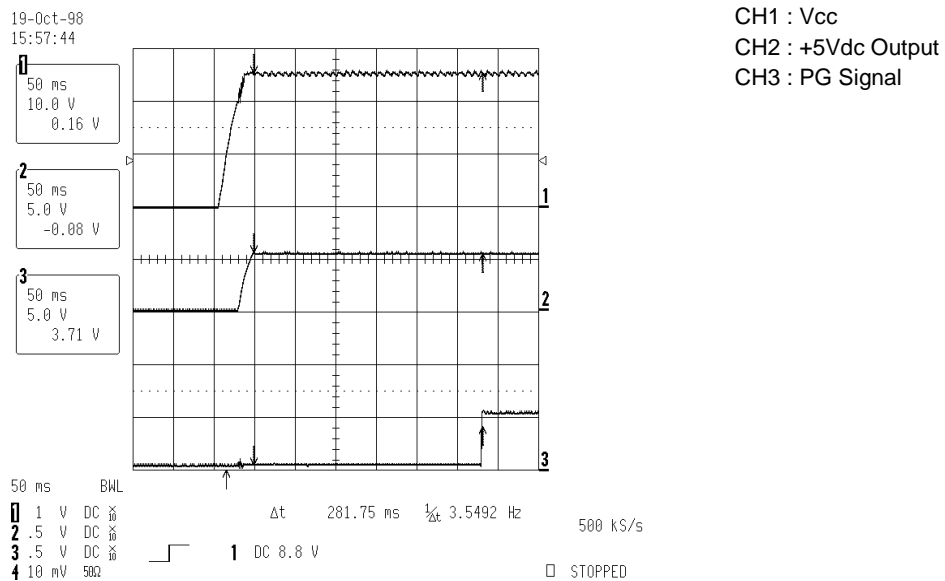
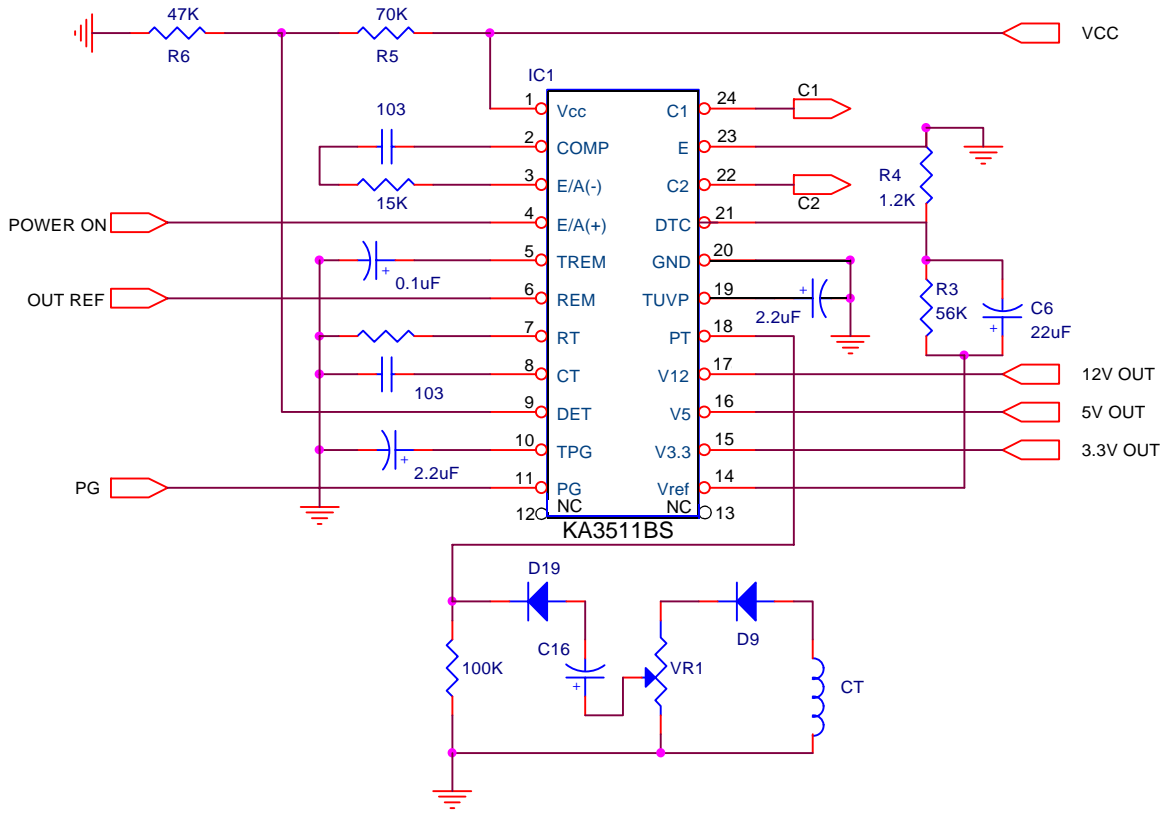

Figure 28. Vcc, +5Vdc Output vs. PG Signal (Low)

Application Circuit



Mechanical Dimensions

Package

Dimensions in millimeters

24-SDIP

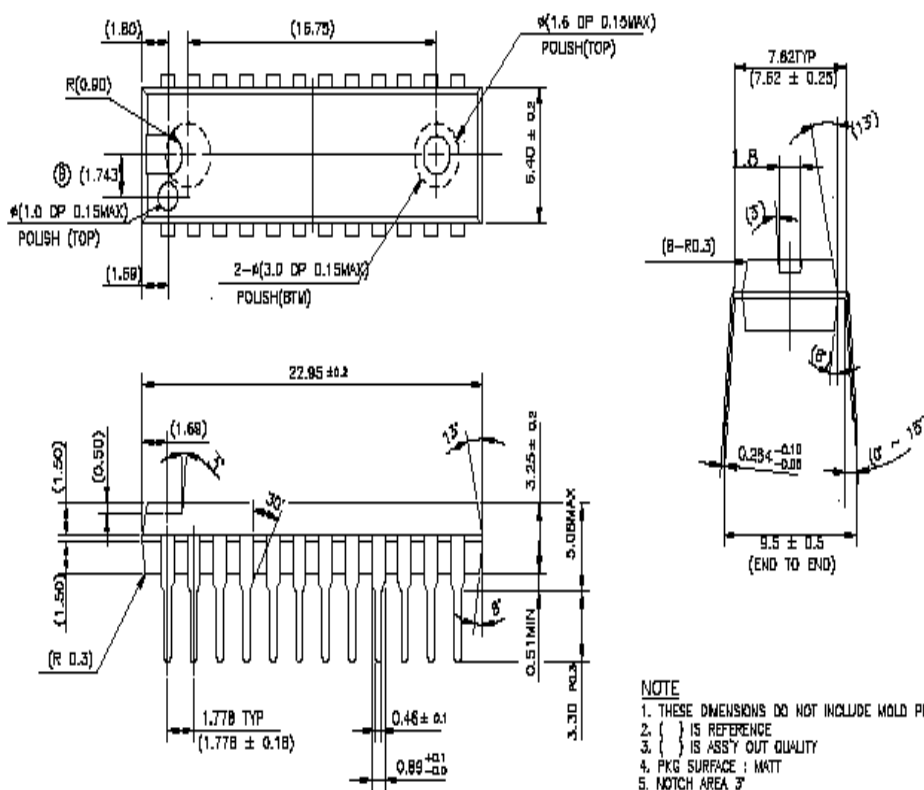

NOTE

1. THESE DIMENSIONS DO NOT INCLUDE MOLD PROTRUSION
2. { } IS REFERENCE
3. { } IS ASSY OUT QUALITY
4. PKG SURFACE : MATT
5. NOTCH AREA 3'

Ordering Information

| Product Number | Package | Operating Temperature |
|-----------------------|----------------|------------------------------|
| KA3511BS | 24-SDIP | 0°C ~ 70°C |

DISCLAIMER

FAIRCHILD SEMICONDUCTOR RESERVES THE RIGHT TO MAKE CHANGES WITHOUT FURTHER NOTICE TO ANY PRODUCTS HEREIN TO IMPROVE RELIABILITY, FUNCTION OR DESIGN. FAIRCHILD DOES NOT ASSUME ANY LIABILITY ARISING OUT OF THE APPLICATION OR USE OF ANY PRODUCT OR CIRCUIT DESCRIBED HEREIN; NEITHER DOES IT CONVEY ANY LICENSE UNDER ITS PATENT RIGHTS, NOR THE RIGHTS OF OTHERS.

LIFE SUPPORT POLICY

FAIRCHILD'S PRODUCTS ARE NOT AUTHORIZED FOR USE AS CRITICAL COMPONENTS IN LIFE SUPPORT DEVICES OR SYSTEMS WITHOUT THE EXPRESS WRITTEN APPROVAL OF THE PRESIDENT OF FAIRCHILD SEMICONDUCTOR CORPORATION. As used herein:

1. Life support devices or systems are devices or systems which, (a) are intended for surgical implant into the body, or (b) support or sustain life, and (c) whose failure to perform when properly used in accordance with instructions for use provided in the labeling, can be reasonably expected to result in a significant injury of the user.
2. A critical component in any component of a life support device or system whose failure to perform can be reasonably expected to cause the failure of the life support device or system, or to affect its safety or effectiveness.