

DUAL DIFFERENTIAL COMPARATOR

The KA293 series consists of two independent voltage comparators designed to operate from a single power supply over a wide voltage range.

FEATURES

- Single Supply Operation: 2V to 36V
- Dual Supply Operation: $\pm 1V$ to $\pm 18V$
- Allow Comparison of Voltages Near Ground Potential
- Low Current Drain 800 μA Typ
- Compatible with all Forms of Logic
- Low Input Bias Current 25nA Typ
- Low Input Offset Current $\pm 5nA$ WP
- Low Offset Voltage $\pm 1mV$ Typ

BLOCK DIAGRAM

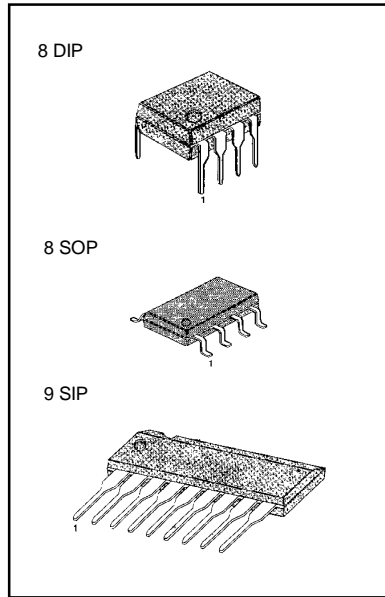
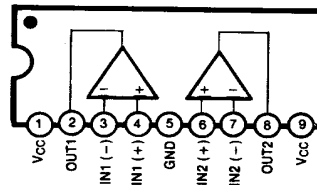
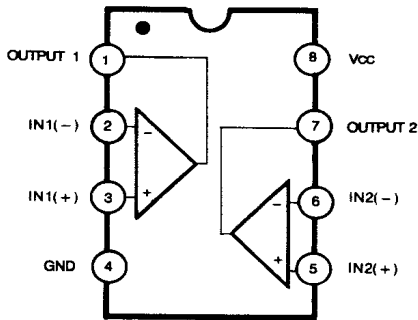

ORDERING INFORMATION

Device	Package	Operating Temperature
KA393 KA393A	8 DIP	0 ~ + 75°C
KA393S KA393AS	9 SIP	
KA393D KA393AD	8 SOP	
KA293 KA293A	8 DIP	
KA293S KA293AS	9 DIP	
KA293D KA293AD	8 SOP	
KA2903 KA2903D KA2903S	8 DIP 8 SOP 9 SIP	-40 ~ + 85°C



SCHEMATIC DIAGRAM

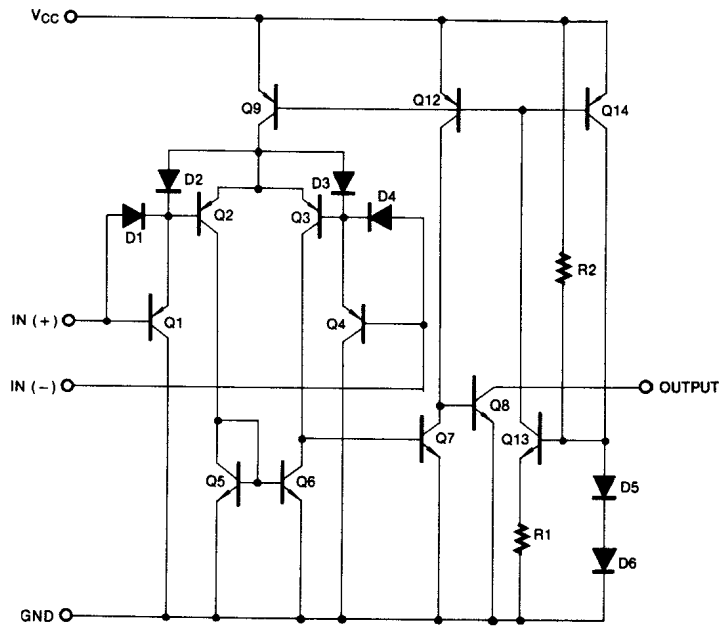

ABSOLUTE MAXIMUM RATINGS

Characteristic	Symbol	Value	Unit
Power Supply Voltage	V_{CC}	± 18 or 36	V
Differential Input Voltage	$V_{I(DIFF)}$	36	V
Input Voltage	V_I	- 0.3 to +36	V
Output Short Circuit to GND		Continuous	
Power Dissipation	P_D	570	mW
Operating Temperature	T_{OPR}	0 ~ + 70	°C
KA393/KA393A		- 25 ~ + 85	
KA293/KA293A KA2903		- 40 ~ + 85	
Storage Temperature	T_{STG}	- 65 ~ + 150	°C

ELECTRICAL CHARACTERISTICS ($V_{CC}=5V$, $T_A=25^\circ C$, unless otherwise specified)

Characteristic	Symbol	Test Conditions	KA293A/KA393A			KA293/KA393			Unit
			Min	Typ	Max	Min	Typ	Max	
Input Offset Voltage	V_{IO}	$V_{CM}=0V$ to $V_{CC}=1.5V$ $V_{O(P)}=1.4V$, $R_S=0\Omega$		± 1	± 2		± 1	± 5	mV
		NOTE 1			± 4.0		± 9.0		
Input Offset Current	I_{IO}			± 5	± 50		± 5	± 50	nA
		NOTE 1			± 150		± 150		
Input Bias Current	I_{BIAS}			65	250		65	250	nA
		NOTE 1			400			400	
Input Common Mode Voltage Range	$V_{I(R)}$		0		$V_{CC}-1.5$	0		$V_{CC}-1.5$	V
		NOTE 1	0		$V_{CC}-2$	0		$V_{CC}-2$	
Supply Current	I_{CC}	$R_L = \infty$ $R_L = \infty$, $V_{CC} = 30V$		0.6	1		0.6	1	mA
				0.8	2.5		0.8	2.5	
Voltage Gain	G_V	$V_{CC}=15V$, $R_L \geq 15K\Omega$ (for large $V_{O(P)swing}$)	50	200		50	200		V/mV
Large Signal Response Time	t_{RES}	$V_I = \text{TTL Logic Swing}$ $V_{REF}=1.4V$, $V_{RL}=5V$, $R_L=5.1K\Omega$		350			350		nS
Response Time	t_{RES}	$V_{RL}=5V$, $R_L=5.1K\Omega$		1.4			1.4		μS
Output Sink Current	I_{SINK}	$V_{I(-)} \geq 1V$, $V_{I(+)}=0V$, $V_{O(P)} \leq 1.5V$	6	18		6	18		mA
Output Saturation Voltage	V_{SAT}	$V_{I(-)} \geq 1V$, $V_{I(+)}=0V$ $I_{SINK}=4mA$		160	400		160	400	mV
		NOTE 1			700		700		
Output Leakage Current	$I_{O(LKG)}$	$V_{I(-)}=0V$, $V_{I(+)}=1V$		0.1			0.1		nA
		$V_{O(P)}=5V$ $V_{O(P)}=30V$			1.0			1.0	μA

NOTE 1

KA393/A: $0 \leq T_A \leq +70^\circ C$ KA293/A: $-25 \leq T_A \leq +85^\circ C$ KA2903: $-40 \leq T_A \leq +85^\circ C$

ELECTRICAL CHARACTERISTICS ($V_{CC} = 5V$, $T_A = 25^\circ C$, unless otherwise specified)

Characteristic	Symbol	Test Conditions	KA2903			Unit
			Min	Typ	Max	
Input Offset Voltage	V_{IO}	$V_{CM} = 0V$ to $V_{CC} = 1.5V$		± 1	± 7	mV
		$V_{O(P)} = 1.4V$, $R_S = 0\Omega$	NOTE 1	± 9	± 15	
Input Offset Current	I_{IO}			± 5	± 50	nA
			NOTE 1	± 50	± 200	
Input Bias Current	I_{BIAS}			65	250	nA
Input Common Mode Voltage Range	$V_{I(R)}$		0		$V_{CC} - 1.5$	V
			NOTE 1	0	$V_{CC} - 2$	
Supply Current	I_{CC}	$R_L = \infty$		0.6	1	mA
		$R_L = \infty$, $V_{CC} = 30V$		1	2.5	
Voltage Gain	G_V	$V_{CC} = 15V$, $R_L \geq 15K\Omega$ (for large $V_{O(P-P)(swing)}$)	25	100		V/mV
Large Signal Response Time	t_{RES}	$V_I = TTL$ Logic Swing $V_{REF} = 1.4V$, $V_{RL} = 5V$, $R_L = 5.1K\Omega$		350		nS
Response Time	t_{RES}	$V_{RL} = 5V$, $R_L = 5.1K\Omega$		1.5		μS
Output Sink Current	I_{SINK}	$V_{I(-)} \geq 1V$, $V_{I(+)} = 0V$, $V_{O(P)} \leq 1.5V$	6	16		mA
Output Saturation Voltage	V_{SAT}	$V_{I(-)} \geq 1V$, $V_{I(+)} = 0V$		160	400	mV
		$I_{SINK} = 4mA$	NOTE 1		700	
Output Leakage Current	$I_{O(LKG)}$	$V_{I(-)} = 0V$,	$V_{O(P)} = 5V$	0.1		nA
		$V_{I(+)} = 1V$	$V_{O(P)} = 30V$		1.0	μA

NOTE 1

KA393/A: $0 \leq T_A \leq +70^\circ C$ KA293/A: $-25 \leq T_A \leq +85^\circ C$ KA2903: $-40 \leq T_A \leq +85^\circ C$

TYPICAL PERFORMANCE CHARACTERISTICS

Fig. 1 SUPPLY CURRENT

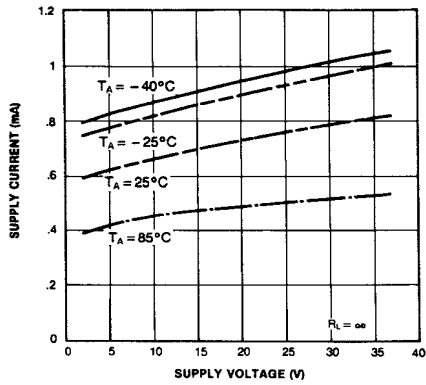

Fig. 2 INPUT CURRENT

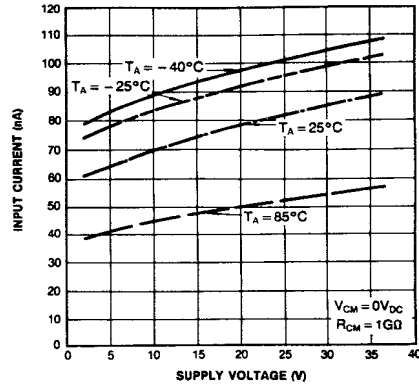

Fig. 3 OUTPUT SATURATION VOLTAGE

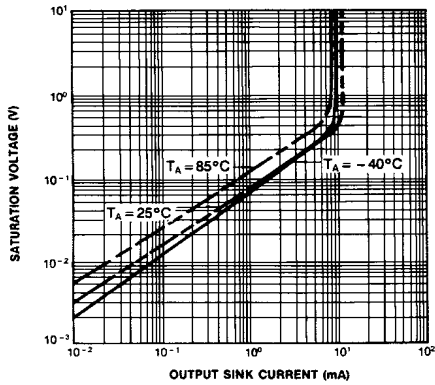

Fig. 4 RESPONSE TIME FOR VARIOUS INPUT OVERDRIVE-NEGATIVE TRANSITION

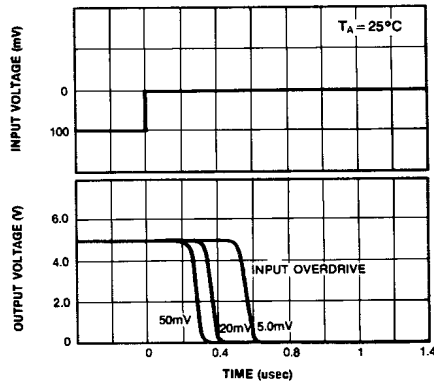
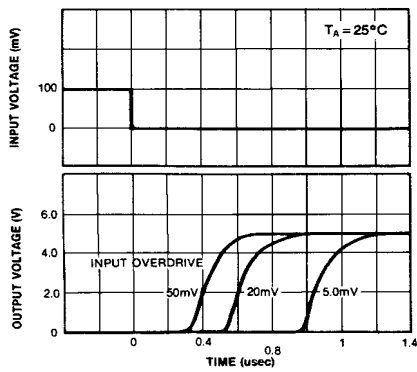
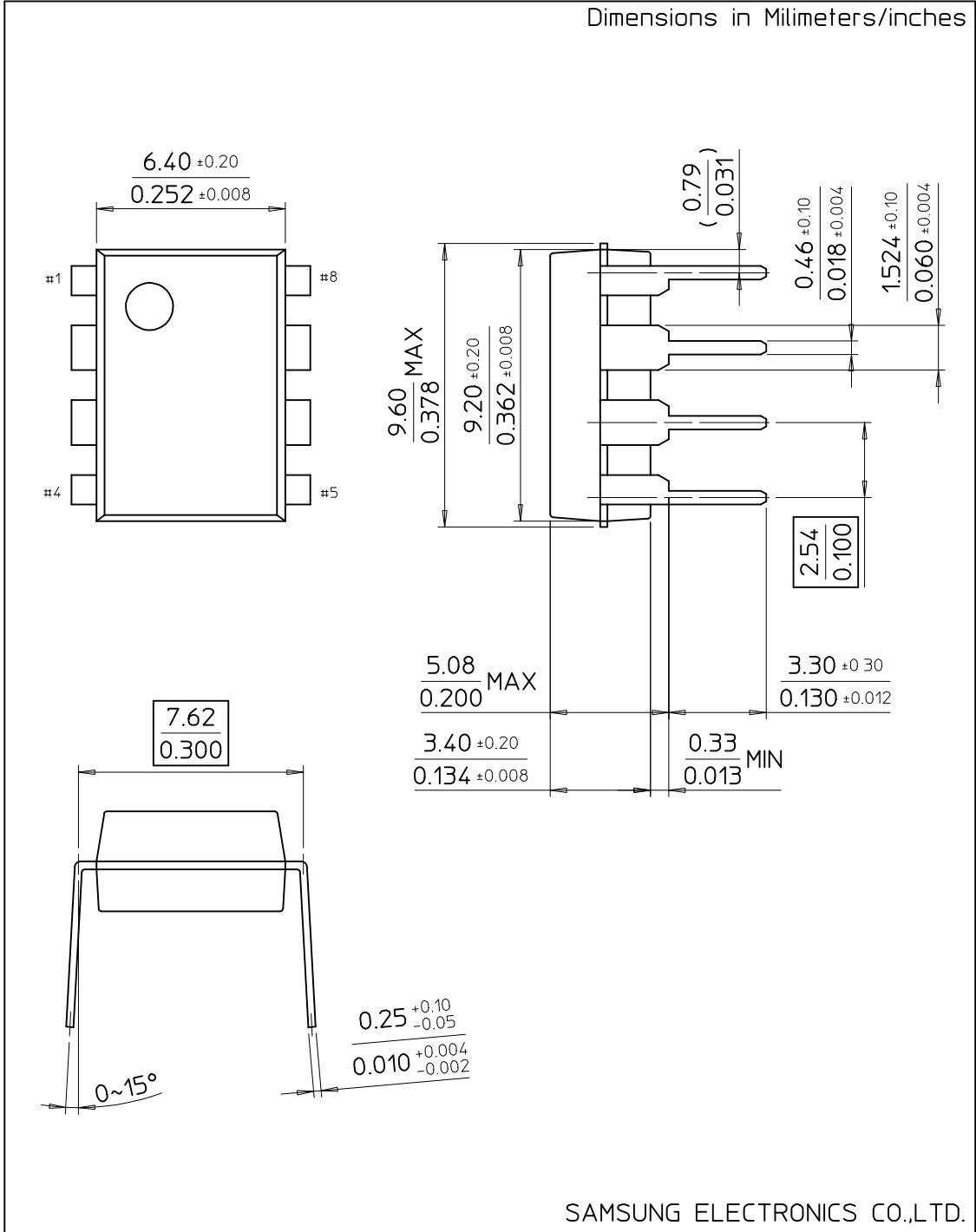

Fig. 5 RESPONSE TIME FOR VARIOUS INPUT OVERDRIVE-POSITIVE TRANSITION



8-DIP-300

Dimensions in Millimeters/inches



SAMSUNG ELECTRONICS CO.,LTD.

8-SOP-225

Dimensions in Millimeters/inches

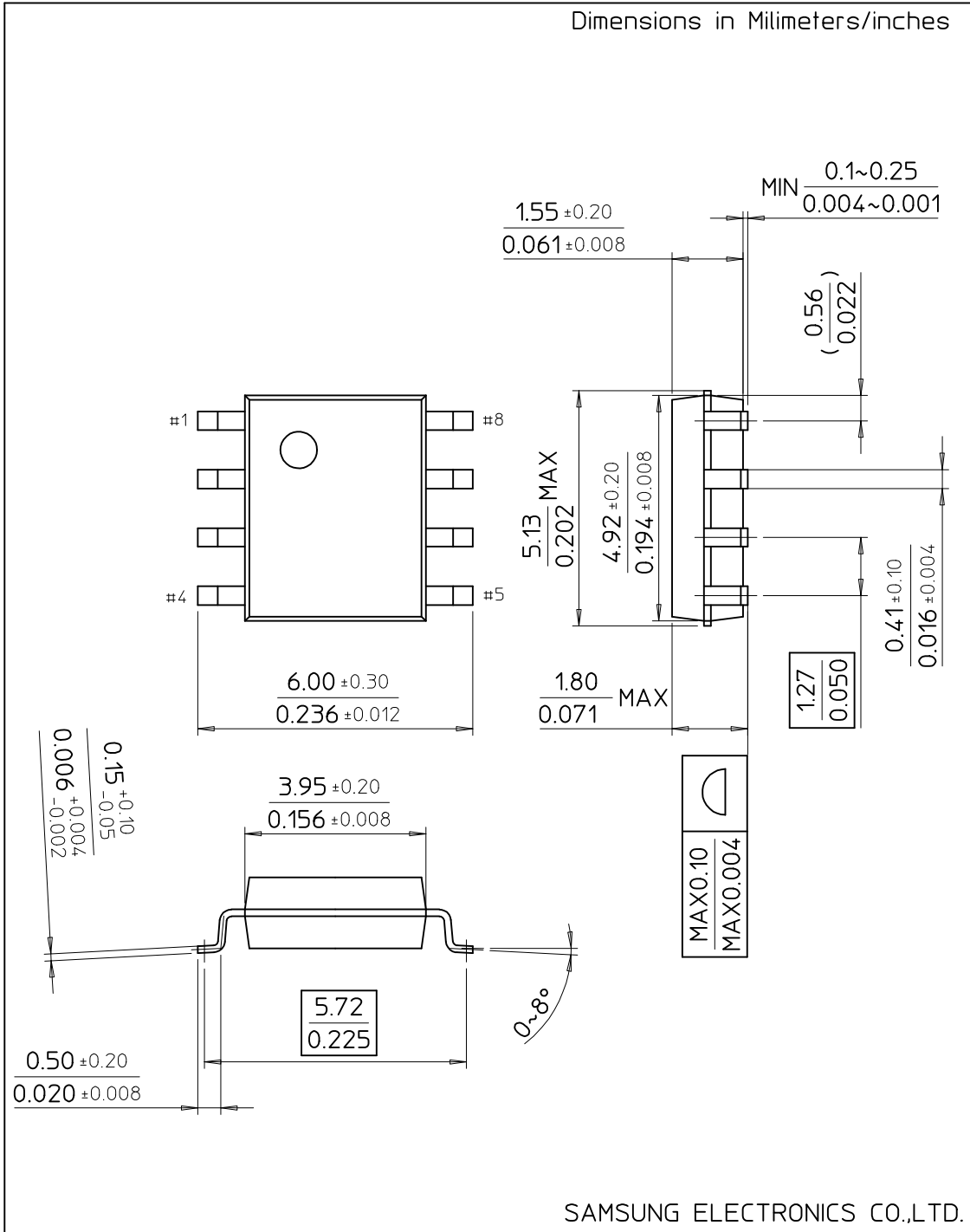

SAMSUNG ELECTRONICS CO.,LTD.

9-SIP

Dimensions in Milimeters/Inches

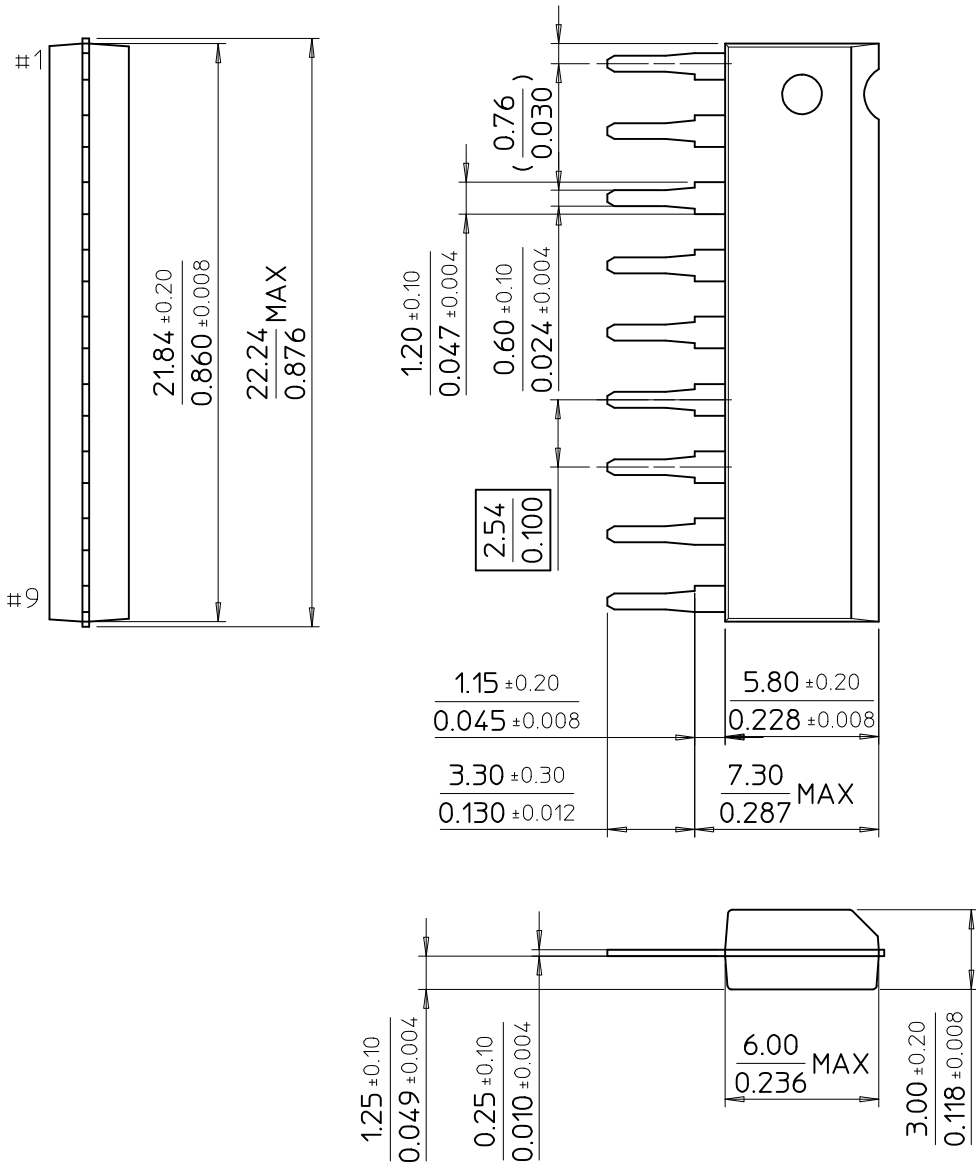

SAMSUNG ELECTRONICS CO.,LTD.