

KA1M0565R

SAMSUNG POWER SWITCH

FEATURES

- Precision fixed operating frequency (70KHz)
- Pulse by pulse over current limiting
- Over Current Protection
- Over Voltage Protection(min. 23V)
- Internal thermal shutdown function
- Under voltage lockout
- Internal high voltage sense FET
- Auto restart

PRODUCT SUMMARY

Part Number	BVdss	Rds(on)	Id
KA1M0565R	650V	2.2Ω	5A

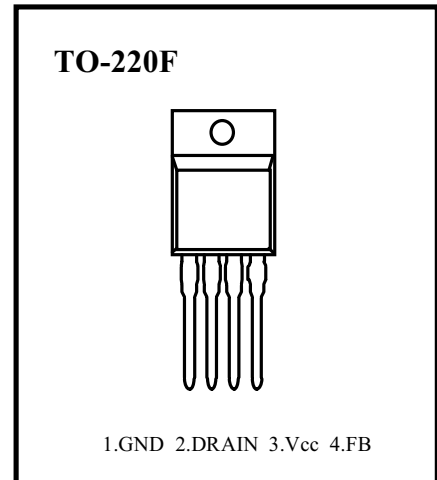

BLOCK DIAGRAM

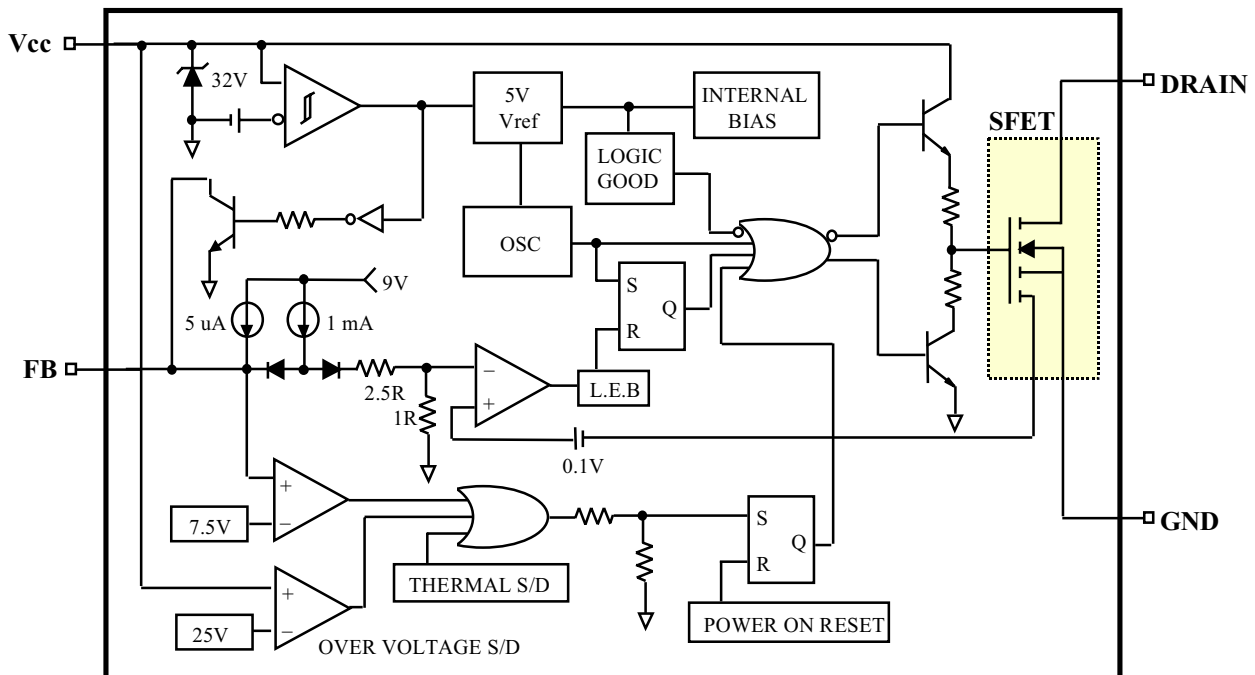

ABSOLUTE MAXIMUM RATINGS

Characteristic	Symbol	Value	Unit
Drain - Source(GND) Voltage (1)	V _{DSS}	650	V
Drain - Gate Voltage (R _{GS} = 1MΩ)	V _{DGR}	650	V
Gate - Source(GND) Voltage	V _{GS}	±30	V
Drain Current Pulsed (2)	I _{DM}	20	A _{DC}
Single Pulsed Avalanche Energy (3)	E _{AS}	230	mJ
Avalanche Current	I _{AS}	-	A
Continuous Drain Current (T _c = 25 °C)	I _D	5.0	A _{DC}
Continuous Drain Current (T _c = 100 °C)	I _D	3.5	A _{DC}
Supply Voltage	V _{CC}	30	V
Analog Input Voltage Range	V _{FB}	-0.3 ~ V _{SD}	V
Total Power Dissipation	P _D (wt H/S)	140	W
	Derating	1.11	W/°C
Operating Temperature	T _{OPR}	- 25 ~ + 85	°C
Storage Temperature	T _{STG}	- 55 ~ + 150	°C

Notes: (1) T_J = 25 °C to 150 °C

(2) Repetitive rating : Pulse width limited by maximum junction temperature

(3) L = 30mH, V_{DD} = 50V, R_G = 27Ω, starting T_j = 25 °C

ELECTRICAL CHARACTERISTICS (SFET part)

(T_a = 25 °C unless otherwise specified)

Symbol	Characteristic	Min	Typ	Max	Units	Test Conditions
BV _{DSS}	Drain-Source Breakdown Voltage	650	-	-	V	V _{GS} =0V, I _D =50uA
I _{DSS}	Zero Gate Voltage Drain Current	-	-	50	uA	V _{DS} =Max, Rating, V _{GS} =0V
		-	-	200	uA	V _{DS} =0.8Max, Rating, V _{GS} =0V TC=125 °C
R _{DS(on)}	Static Drain-Source On Resistance(4)	-	1.76	2.2	Ω	V _{GS} = 10V, I _D = 2.5A

ELECTRICAL CHARACTERISTICS (SFET part continued)

(Ta = 25 °C unless otherwise specified)

Symbol	Characteristic	Min	Typ	Max	Units	Test Conditions
g _{fs}	Forward Transconductance(4)	2.5	-	-	mho	V _{DS} =50V, I _D =2.5A
C _{iss}	Input Capacitance	-	1457	-	pF	V _{GS} = 0V, V _{DS} = 25V, f = 1MHz
C _{oss}	Output Capacitance	-	130	-		
C _{rss}	Reverse Transfer Capacitance	-	38.8	-		
t _{d(on)}	Turn On Delay Time	-	-	60	nS	V _{DD} = 0.5BV _{DSS} , I _D = 5.0A (MOSFET switching time are essentially independent of operating temperature)
t _r	Rise Time	-	-	150		
t _{d(off)}	Turn Off Delay Time	-	-	300		
t _f	Fall Time	-	-	130		
Q _g	Total Gate Charge (Gate-Source + Gate-Drain)	-	-	56	nC	V _{GS} = 10V, I _D = 5.0A V _{DS} = 0.5BV _{DSS} (MOSFET switching time are essentially independent of operating temperature)
Q _{gs}	Gate-Source Charge	-	10.3	-		
Q _{gd}	Gate-Drain(Miller) Charge	-	22.3	-		

Notes: (1) T_J = 25 °C to 150 °C

(2) Repetitive rating : Pulse width limited by maximum junction temperature

(3) L = 30mH, V_{DD} = 50V, R_G = 25Ω, starting T_j = 25 °C

(4) Pulse Test : Pulse width ≤ 300uS, Duty Cycle ≤ 2 %

ELECTRICAL CHARACTERISTICS (Control part)

(Ta = 25°C unless otherwise specified)

Symbol	Characteristics	Min	Typ	Max	Unit	Test Conditions
REFERENCE SECTION						
Vref	Output Voltage (Note 1)	4.80	5.00	5.20	V	Ta = 25°C
Vref/ ΔT	Temperature Stability (Note 1&2)	-	0.3	0.6	mV/°C	-25°C ≤ Ta ≤ +85°C
OSCILLATOR SECTION						
FOSC	Initial Accuracy	61	67	73	KHz	Ta = 25°C
ΔF / ΔT	Frequency Change with Temperature (Note 2)	-	±5	±10	%	-25°C ≤ Ta ≤ +85°C
PWM SECTION						
DMAX	Maximum Duty Cycle	74	77	80	%	
FEEDBACK SECTION						
I FB	Feedback Source Current	0.7	0.9	1.1	mA	Ta = 25°C, 0 V ≤ Vfb ≤ 3V
Idelay	Shutdown Delay Current	4.0	5.0	6.0	uA	Ta = 25°C, 5 V ≤ Vfb ≤ VSD
OVER CURRENT PROTECTION SECTION						
IL(MAX)	Over Current Protection	3.08	3.5	3.92	A	Max. Inductor Current
UVLO SECTION						
Vth(H)	Start Threshold Voltage	14	15	16	V	
Vth(L)	Minimum Operating Voltage	9	10	11	V	After turn on

ELECTRICAL CHARACTERISTICS (Continued)

(Ta = 25°C unless otherwise specified)

Symbol	Characteristics	Min	Typ	Max	Unit	Test Conditions
TOTAL STANDBY CURRENT SECTION						
I _{ST}	Start up Current	0.1	0.3	0.45	mA	V _{CC} = 14V
I _{OPR}	Operating Supply Current (control part only)	6	12	18	mA	Ta = 25°C
V _Z	V _{CC} Zener Voltage	30	32.5	35	V	I _{CC} = 20mA
SHUTDOWN SECTION						
V _{SD}	Shutdown Feedback Voltage	6.9	7.5	8.1	V	
T _{SD}	Thermal Shutdown Temperature(T _j)	140	160	-	°C	(Note 1)
V _{ovp}	Over Voltage Protection Voltage	23	25	28	V	

- Notes:** (1) These parameters, although guaranteed, are not 100% tested in production
(2) These parameters, although guaranteed, are tested in EDS(wafer test) process

TYPICAL PERFORMANCE CHARACTERISTICS

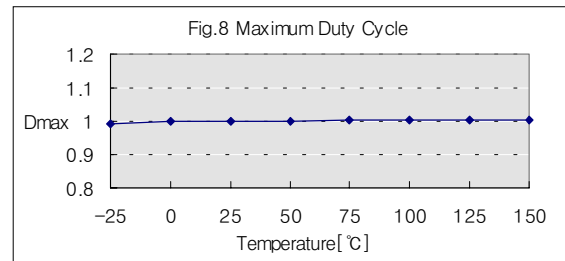
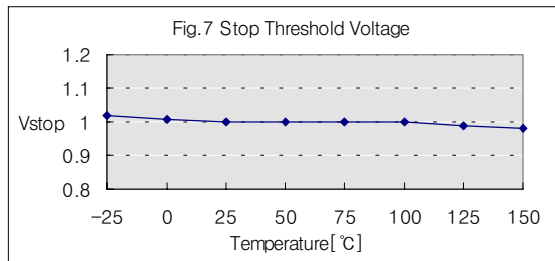
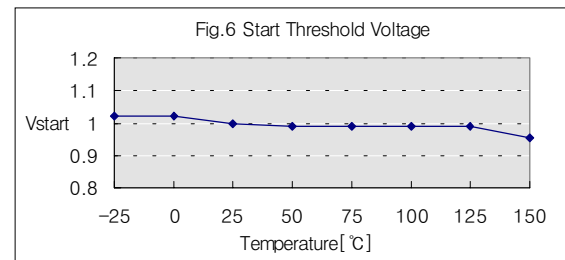
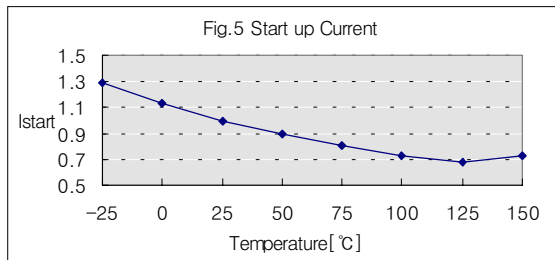
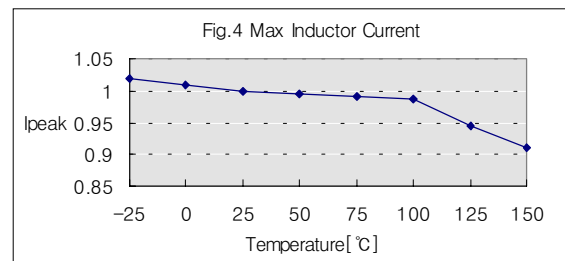
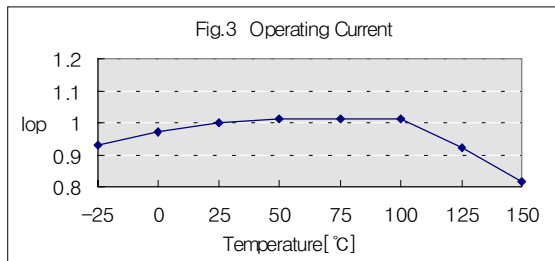
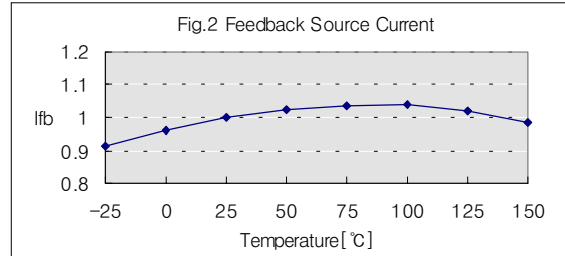
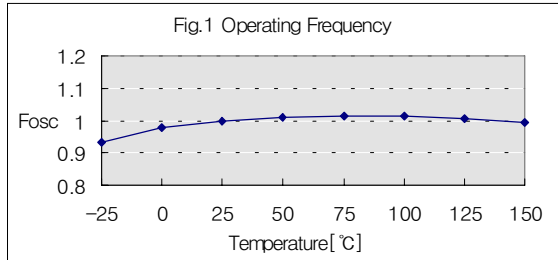

TYPICAL PERFORMANCE CHARACTERISTICS (Continued)

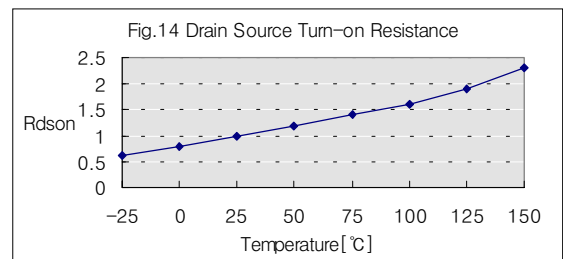
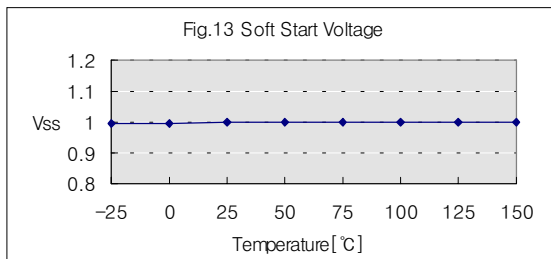
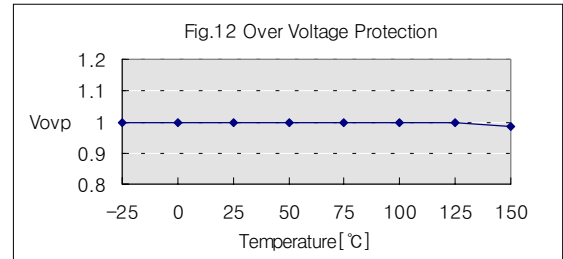
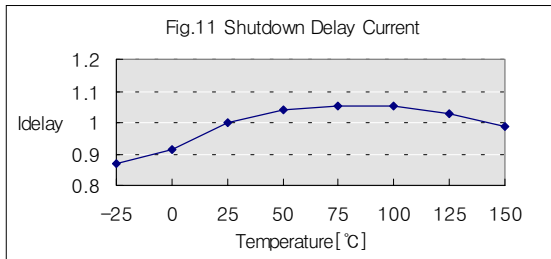
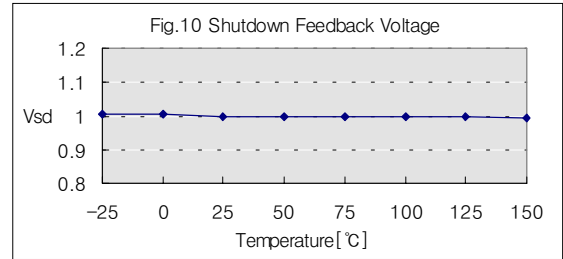
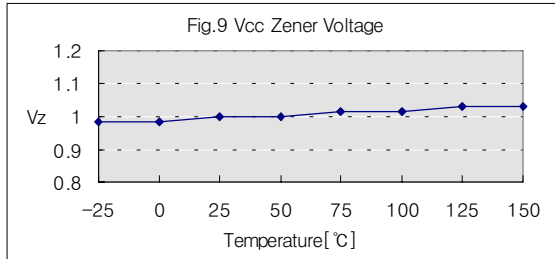

TO-220F

Dimensions in Millimeters

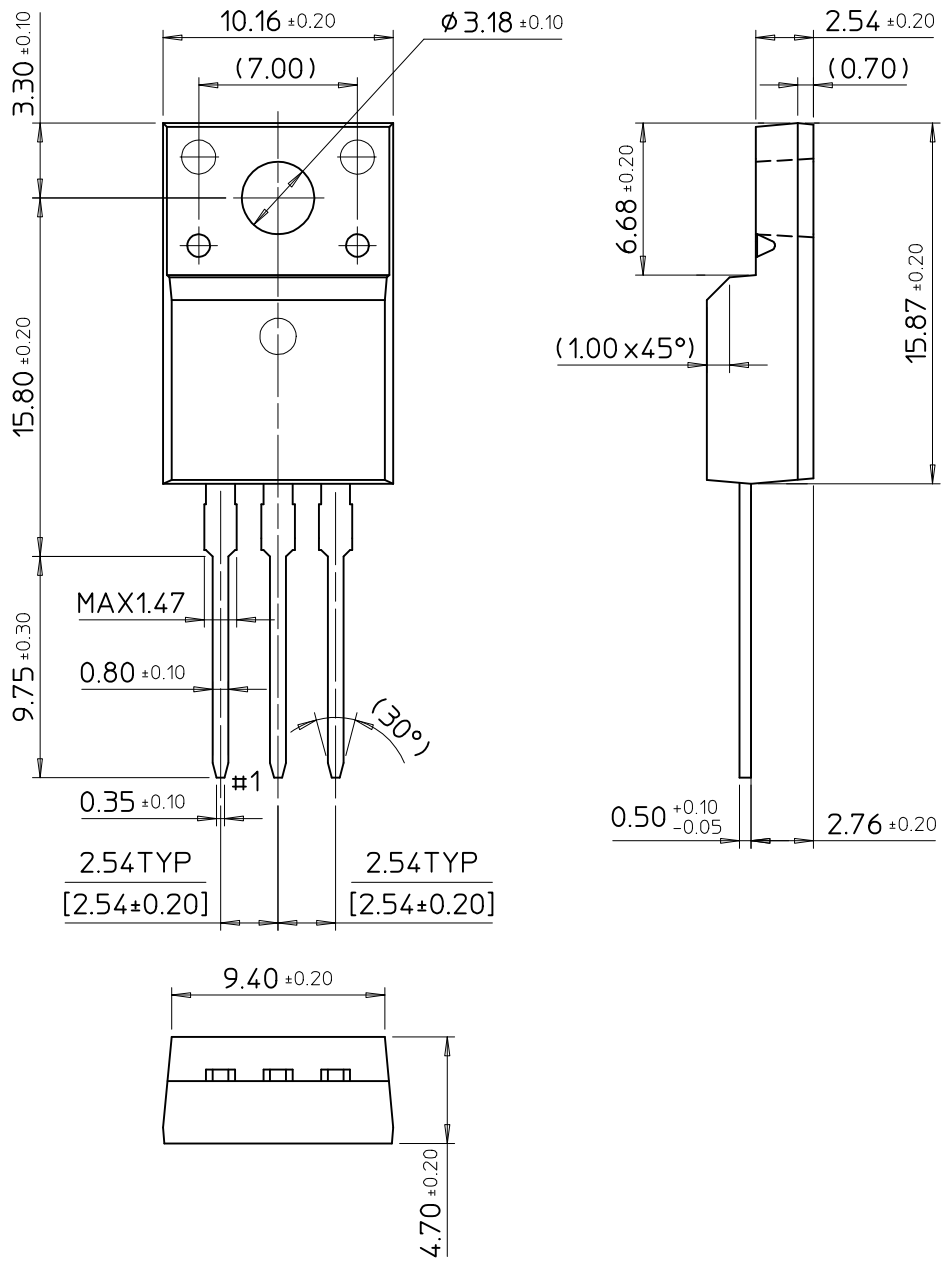

SAMSUNG ELECTRONICS CO.,LTD.