

# FAN2560

## 350mA Low-V<sub>IN</sub> LDO with Fast Transient Response

### Features

- 55µA Typical Quiescent Current
- Up to 350mA Output Current
- 2.9V to 5.5V Bias Supply Voltage
- V<sub>OUT</sub>+0.1V to 5.5V Power Input Supply Voltage
- Fixed Voltage Options: 1.3V and 1.5V
- Thermal Shutdown Protection (TSD)
- Input Under-Voltage Lockout (UVLO)
- Short-Circuit Current Protection (SCP)
- 5-bump 0.96 x 1.33mm WLCSP

### Applications

- Moderate Current Digital Loads
- DVB-H, DMB Processors
- Handsets, Smart Phones
- WLAN DC-DC Converter Modules
- PDA, DSC, PMP, and MP3 Players
- Portable Hard Disk Drives

### Description

The FAN2560 is a linear low-dropout (LDO) regulator with a split-supply architecture. Separate bias and supply inputs allow bias to be taken directly from the battery, while the input is taken from a lower pre-regulated source. This allows a smaller differential voltage between input and output, which provides greater efficiency over a wider V<sub>BAT</sub> range.

The FAN2560 is available in a fixed-voltage output, 5-bump, WLCSP package.

### Typical Applications

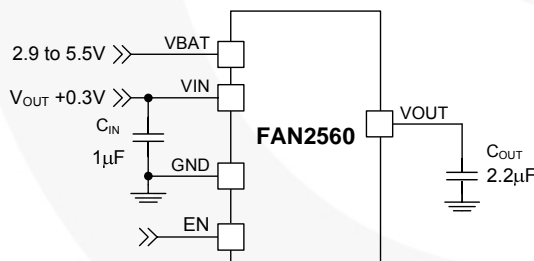

Figure 1. Separate Supply and Bias Line

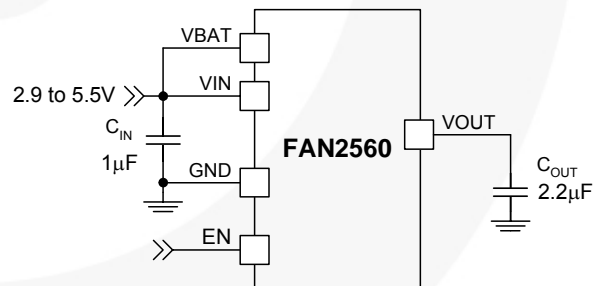

Figure 2. Connected Supply and Bias Line

### Ordering Information

Part Number	Operating Temperature Range	Package	Eco Status	Packing Method
FAN2560UC13X	-40°C to 85°C	WLCSP-5 0.96 x 1.33mm	Green	Tape and Reel
FAN2560UC15X	-40°C to 85°C	WLCSP-5 0.96 x 1.33mm	Green	Tape and Reel

For Fairchild's definition of Eco Status, please visit: [http://www.fairchildsemi.com/company/green/rohs\\_green.html](http://www.fairchildsemi.com/company/green/rohs_green.html).

### Block Diagram

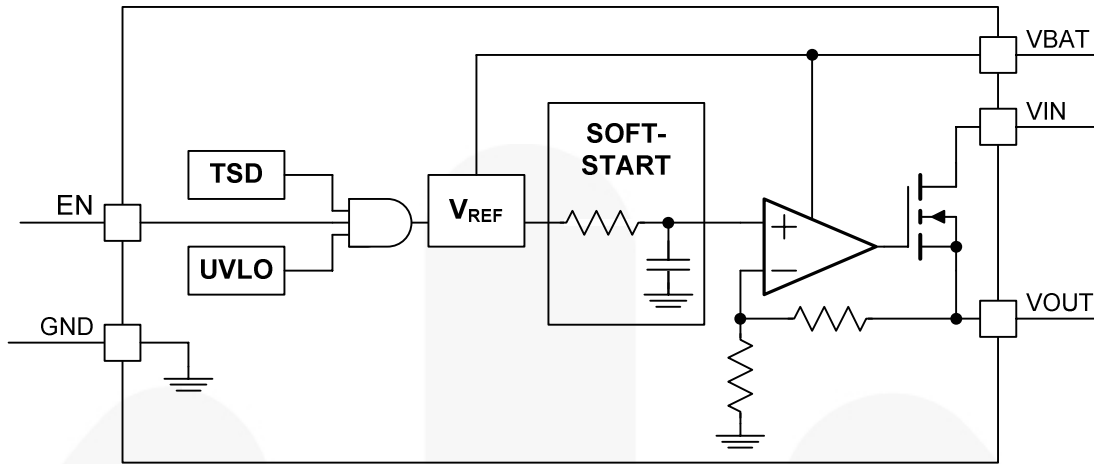

Figure 3. IC Block Diagram

### Pin Configuration

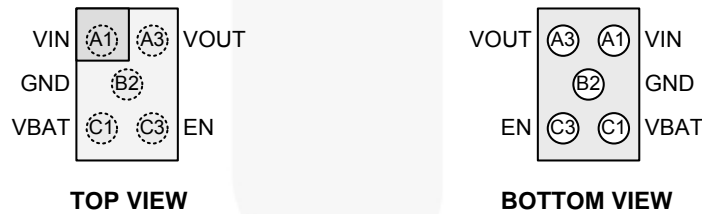

Figure 4. 0.96 x 1.33mm WLCSP package

### Pin Definitions

Pin #	Name	Description
A1	VIN	Power supply input. A minimum 1 $\mu$ F MLCC is required to GND.
A3	VOUT	Output Voltage. A typical $C_{OUT}$ =1 $\mu$ F to 2.2 $\mu$ F MLCC is required to GND, placed close to the $V_{OUT}$ terminal.
C1	VBAT	Battery bias supply input. No capacitor is required unless another bulk capacitor is more than few inches away.
C3	EN	Enable input. The device is in shutdown mode when the voltage at this pin is <0.4V and enabled when >1.1V. The EN latches the LOW logic state once externally forced. Do not leave this pin floating when the device is turned ON.
B2	GND	Ground pin. Connect to a PCB GND plane.

## Absolute Maximum Ratings

Stresses exceeding the absolute maximum ratings may damage the device. The device may not function or be operable above the recommended operating conditions and stressing the parts to these levels is not recommended. In addition, extended exposure to stresses above the recommended operating conditions may affect device reliability. The absolute maximum ratings are stress ratings only.

Symbol	Parameter	Min.	Max.	Units
	$V_{BAT}$ , $V_{IN}$ , EN	-0.3	6.0	V
$V_{OUT}$	Output Voltage	-0.3	$V_{IN} + 0.3V$	V
$T_J$	Junction Temperature	-40	+150	°C
$T_{STG}$	Storage Temperature	-65	+150	°C
$T_L$	Lead Soldering Temperature, 10 Seconds		+260	°C
ESD	Electrostatic Discharge Protection Level	Human Body Model per JESD22-A114	3.5	kV
		Charged Device Model per JESD22-C101	1.5	

## Recommended Operating Conditions

The Recommended Operating Conditions table defines the conditions for actual device operation. Recommended operating conditions are specified to ensure optimal performance to the datasheet specifications. Fairchild does not recommend exceeding them or designing to absolute maximum ratings.

Symbol	Parameter	Min.	Typ.	Max.	Units
$V_{BAT}$	Bias Supply Range, $(V_{OUT} + 1.4V) < V_{BAT}$	2.9		5.5	V
$V_{IN}$	Power Supply Range, $(V_{IN} < V_{BAT})$	$V_{OUT} + V_{DO}$		$V_{BAT}$	V
$I_{OUT}$	Output Current	0		350	mA
$C_{IN}$	Input Capacitor (Effective Capacitance)	0.7	1.0		$\mu F$
	Equivalent Series Resistance (ESR)	0		300	m $\Omega$
$C_{OUT}$	Output Capacitor (Effective Capacitance)	0.7	2.2	12.0	$\mu F$
	Equivalent Series Resistance (ESR)	3		300	m $\Omega$
$T_A$	Operating Ambient Temperature Range	-40		+85	°C
$T_J$	Operating Junction Temperature Range	-40		+125	°C

## Thermal Properties

Symbol	Parameter	Min.	Typ.	Max.	Units
$\Theta_{JA}$	Junction-to-Ambient Thermal Resistance		180 <sup>(1)</sup>		°C/W

### Note:

- 1 Junction-to-ambient thermal resistance is a function of application and board layout. This data is measured with four-layer boards in accordance to JESD51- JEDEC standard. Special attention must be paid not to exceed junction temperature  $T_{J(max)}$  at a given ambient temperature  $T_A$ .

## Electrical Characteristics

$V_{BAT}=2.9V$  to  $5.5V$ ,  $V_{IN}=V_{OUT} + 0.3V$ ,  $T_A=-40^{\circ}C$  to  $+85^{\circ}C$ , Test Circuit Figure 1, unless otherwise noted. Typical values are at  $T_A=25^{\circ}C$ ,  $V_{BAT}=3.6V$ ,  $I_{LOAD}=1mA$ ,  $V_{EN}=1.8V$ .

Symbol	Parameter	Conditions	Min.	Typ.	Max.	Units	
<b>Power Supplies</b>							
$V_{BAT}$	Battery Input Supply	$(V_{OUT} + 1.4V) < V_{BAT}$	2.9		5.5	V	
$V_{IN}$	Input Voltage Range	$V_{IN} < V_{BAT}$	$V_{OUT} + V_{DO}$		$V_{BAT}$	V	
$I_{BAT}$	$V_{BAT}$ Supply Current	$I_{LOAD}=0\mu A$		55	70	$\mu A$	
$I_{IN}$	$V_{IN}$ Supply Current	$I_{LOAD}=0\mu A$		4	11	$\mu A$	
$I_{VBATSD}$	$V_{BAT}$ Shutdown Supply Current	$V_{BAT}=3.6V$ , EN=GND		0.01	1.00	$\mu A$	
$I_{VINS D}$	$V_{IN}$ shutdown Supply Current	$V_{BAT}=3.6V$ , EN=GND		0.01	1.00	$\mu A$	
$V_{UVLO}$	Under-voltage Lockout Threshold	$V_{BAT}$ Falling Edge		2.0	2.4	V	
		Hysteresis		0.05		V	
$V_{(EN)}$	Enable High-level Input Voltage		1.1			V	
	Enable Low-level Input Voltage				0.4	V	
$I_{(EN)}$	Enable Input Leakage Current	EN= $V_{IN}$ or GND		0	0.5	$\mu A$	
<b>Regulation</b>							
$I_{OUT}$	Maximum Output Current		350			mA	
$V_{DO}$	Dropout Voltage with Respect to $V_{IN}^{(2)}$	$I_{LOAD}=350mA$		70	200	mV	
$\Delta V_{OUT}$	Output Voltage Accuracy	Over Full $V_{IN}$ , $I_{OUT}$ , and Temperature Range	-2		2	%	
$\Delta V_{OUTline}$	Line Regulation	Over Full $V_{IN}$ , $V_{BAT}$ , $I_{OUT}$ Range		< 6		mV	
$\Delta V_{OUTload}$	Load Regulation						
$I_{SCP}$	Short-circuit Current Limit			400		mA	
$I_{SU}$	Start-up Peak Current	$V_{BAT}$ and $V_{IN}$ applied, EN from L to H, no load, $T_A=-30C$ to $+85C$	$3V < V_{BAT} < 4.5V$		130	300	mA
			$2.9V < V_{BAT} < 5.5V$			500	
TSD	Thermal Shutdown	Rising Temperature		150		$^{\circ}C$	
		Hysteresis		10		$^{\circ}C$	
PSRR	Power Supply Rejection Ratio	$V_{IN}$ , 10Hz to 10kHz		> 60		dB	
		$V_{BAT}$ , 10Hz to 10kHz		> 50			
$e_n$	Output Noise Voltage	10Hz to 100kHz		60		$\mu V_{RMS}$	
<b>Timing Characteristics</b>							
Peak $\Delta V_{OUTline}$	Line Transient Response	600mV, $t_{RISE}=t_{FALL}=10\mu s$		$\pm 2$		mV	
Peak $\Delta V_{OUTload}$	Load Transient Response	0 to 300mA, $t_{RISE}=t_{FALL}=1\mu s$		$\pm 15$		mV	
$t_{ON}$	Turn-on Time			70	200	$\mu s$	

### Note:

- 2 Dropout voltage is the minimum input to output differential voltage needed to maintain  $V_{OUT}$  in regulation, in specified conditions

## Typical Characteristics

Unless otherwise specified,  $C_{IN}=1\mu F$  ceramic,  $C_{OUT}=2.2\mu F$  ceramic,  $V_{IN}=V_{OUTnom} + 0.3V$ ,  $V_{BAT}=3.6V$ ,  $T_A=25^\circ C$ ,  $V_{EN}=1.8V$ .

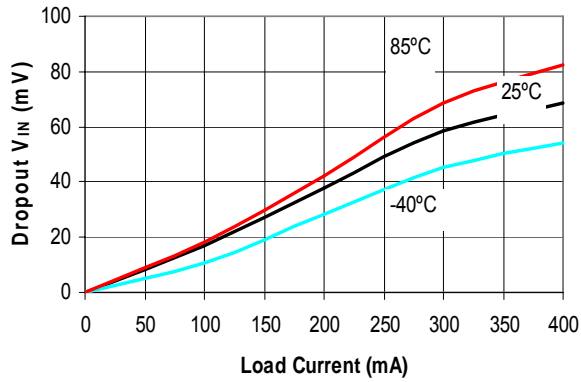

Figure 5. Dropout Voltage vs. Load Current

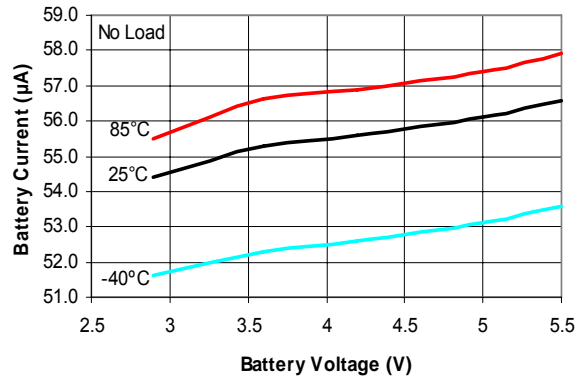

Figure 6. Battery Quiescent Supply Current

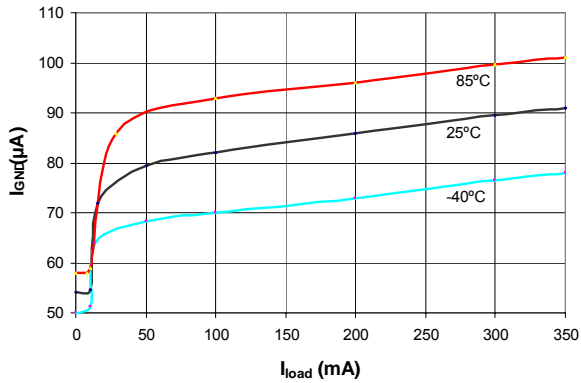

Figure 7. GND Current vs. Load Current

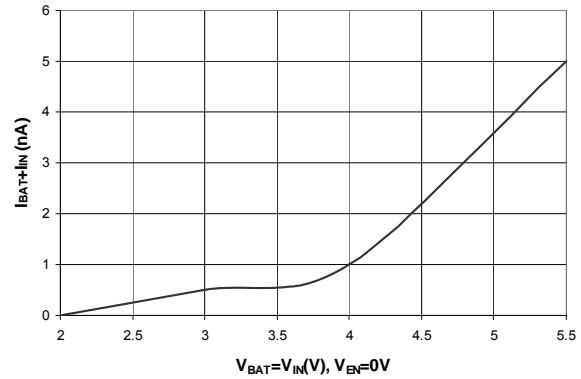

Figure 8. Off Mode Current

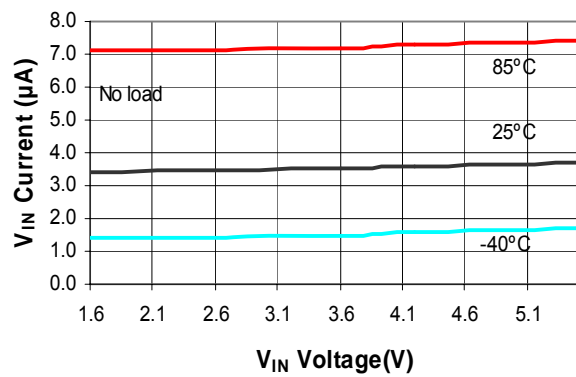

Figure 9. Input  $V_{IN}$  Quiescent Current ( $V_{BAT}=5.5V$ )

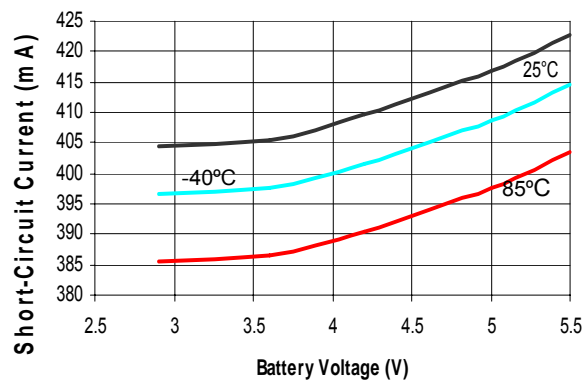
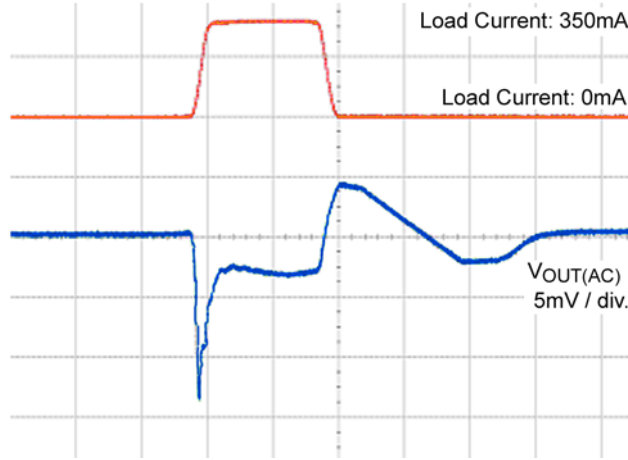
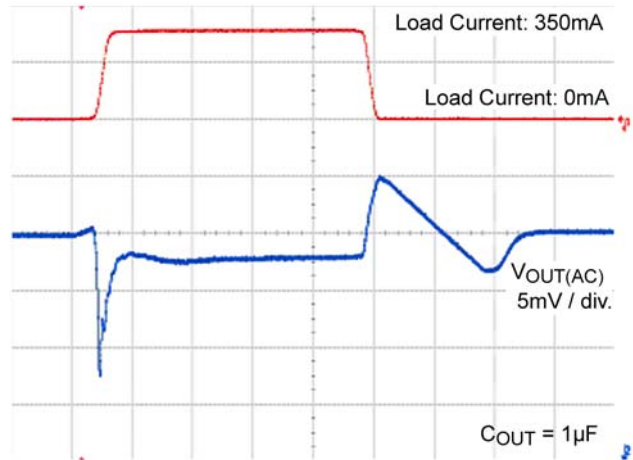

Figure 10. Output Short-Circuit Current

**Typical Characteristics** (Continued)



**Figure 11. Load Transient Response (5µs/div.)**



**Figure 12. Load Transient Response (5µs/div.)**

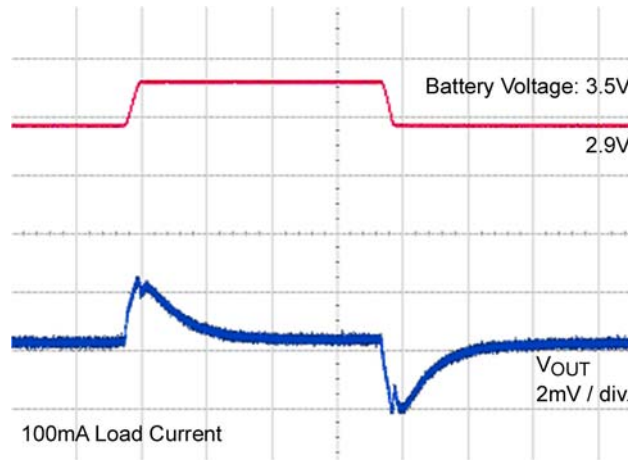

**Figure 13. Line Transient Response (50µs/div.)**

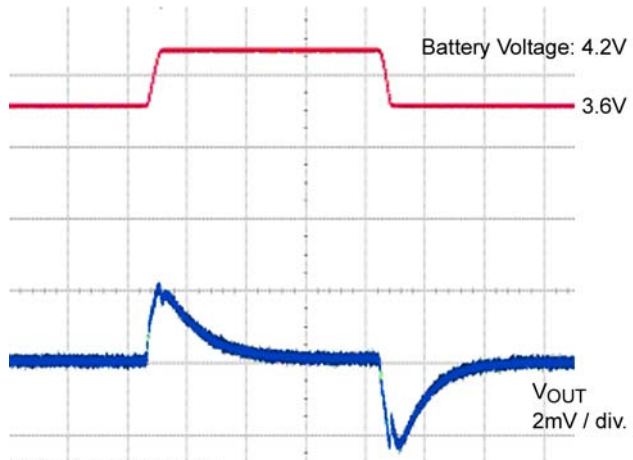

**Figure 14. Line Transient Response (50µs/div.)**

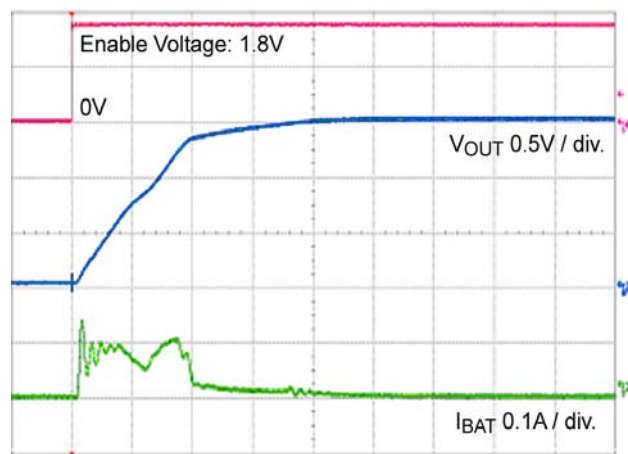

**Figure 15. Start-up and Inrush Current (20µs/div.)**

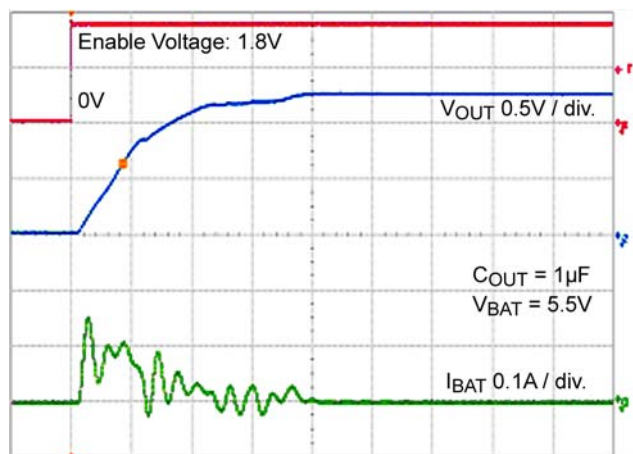

**Figure 16. Start-up and Inrush Current (20µs/div.)**

Typical Characteristics (Continued)

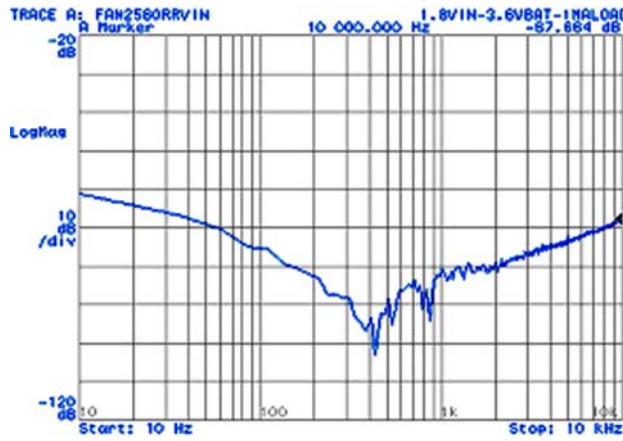

Figure 17. PSRR  $V_{IN}$ , 10Hz to 10kHz, 1mA

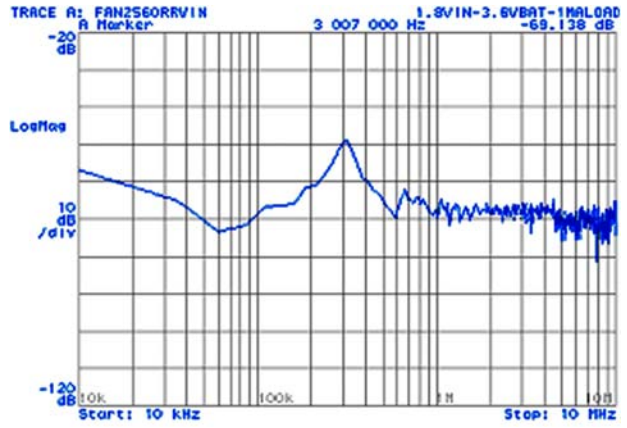

Figure 18. PSRR  $V_{IN}$ , 10kHz to 10MHz, 1mA

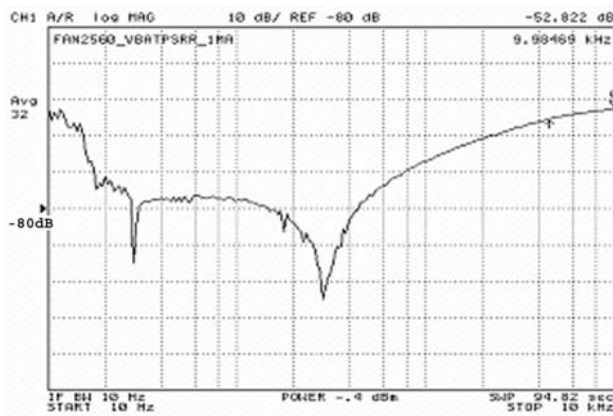

Figure 19. PSRR  $V_{BAT}$ , 10Hz to 10kHz, 1mA

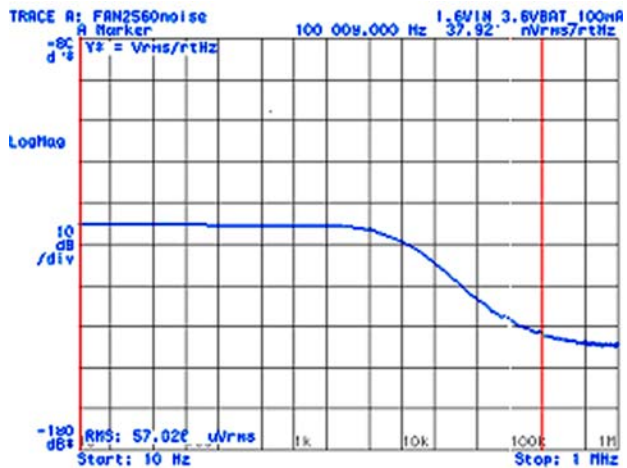

Figure 20. Noise Spectral Power Density, 100mA

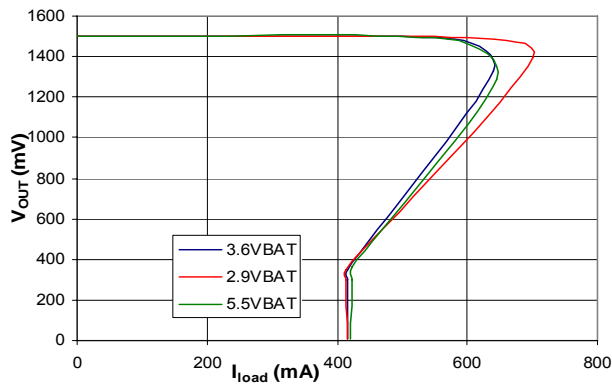

Figure 21. Output Current Voltage Characteristic, 1.5V Option

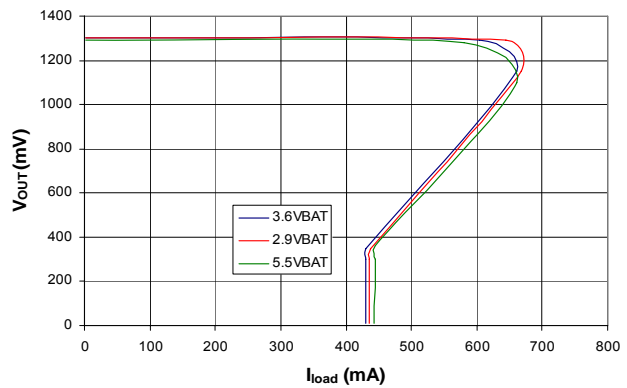

Figure 22. Output Current Voltage Characteristic, 1.3V Option

## Application Information

### ENABLE Latch

A pull-down resistor latches the LOW state of the EN input after this input is externally forced LOW. A low-side switch turns ON a 370 k $\Omega$  pull-down resistance to keep the EN in LOW state, even if the EN input is subsequently left floating.

### Soft-Start

A soft-start function prevents an excessive input current flow during start-up. When the LDO is enabled, the soft-start circuit limits the peak inrush current below the specified maximum value, which increases when  $C_{OUT}$  increases. To further reduce the peak inrush current, the output capacitance may be lowered to 1 $\mu$ F, taking advantage of FAN2560 stability over a wide range of  $C_{OUT}$  capacitance.

### Short-Circuit and Thermal Protection

The FAN2560 output current voltage characteristic has a fold-back shape that indicates a short-circuit current limit lower than the maximum load current. Although the short-circuit current is limited to below 500mA, the device can supply high peak output currents of up to 1A for brief periods. However, this output overload may cause the die temperature to increase and exceed maximum ratings due to power dissipation. In such cases, depending upon the ambient temperature,  $V_{IN}$ , load current, and the junction-to-air thermal resistance ( $\theta_{JA}$ ) of the die, the device may enter thermal shutdown. During output overload conditions, when the die temperature exceeds the shutdown limit temperature of 150 $^{\circ}$ C, the onboard thermal protection disables the output until the temperature drops below this limit, at which point the output is re-enabled.

### Thermal Considerations

For best performance, the die temperature and the power dissipated should be kept at moderate values. The maximum power dissipated can be evaluated based on the following relationship:

$$P_{D(max)} = \left\{ \frac{T_{J(max)} - T_A}{\theta_{JA}} \right\} \quad (1)$$

where  $T_{J(max)}$  is the maximum allowable junction temperature of the die, which is 125 $^{\circ}$ C, and  $T_A$  is the ambient operating temperature.  $\theta_{JA}$  is dependent on the surrounding PCB layout and can be improved by providing a heat sink of surrounding copper ground.

The addition of backside copper with through-holes, stiffeners, and other enhancements can also aid in reducing  $\theta_{JA}$ . The heat contributed by the dissipation of other devices located nearby must be included in design considerations.

### Reverse Current Path

During normal operation,  $V_{IN}$  is higher than  $V_{OUT}$  and the parasitic diode for the series power FET is reverse biased. If the output voltage is externally forced above the input voltage, the parasitic diode gets forward biased and starts to conduct. In this case, it is necessary to limit the reverse current to maximum 100mA to avoid adversely affecting reliability.

### Capacitors Selection

The FAN2560 is stable with a wide range of ceramic output capacitors. An output capacitor of at least 0.7 $\mu$ F effective capacitance and the minimum ESR over the frequency range of 3 to 300m $\Omega$  is required to ensure stability over the full range of supply voltages and load currents. High-ESR tantalum or electrolytic capacitors may be used, but a low ESR ceramic capacitor has to be connected in parallel at the output, at a distance no more than 1-inch from the  $V_{OUT}$  pin. The MLCC capacitors indicated in Table 1 have been successfully tested with the FAN2560.

**Table 1. Recommended Capacitors**

Capacitance	Size	Vendor	Part number
1 $\mu$ F	0603	MURATA	GRM188R71C105KA120
2.2 $\mu$ F	0603	MURATA	GRM188R61A225KF340
2.2 $\mu$ F	0402	MURATA	GRM155R60J225ME15



### Application Example: Post Regulator for a Switching Converter

The FAN2560 is an ideal choice for battery-powered equipment. The low quiescent bias current can be supplied directly from the battery, while the input voltage can come from a high-efficiency buck regulator, like FAN5350. This combination provides both best

efficiency and low noise output. As can be seen in the scope pictures below the schematic, the already-low output voltage ripple, inherent to a switching regulator, is significantly attenuated by the FAN2560 at any frequency within the switching operating range.

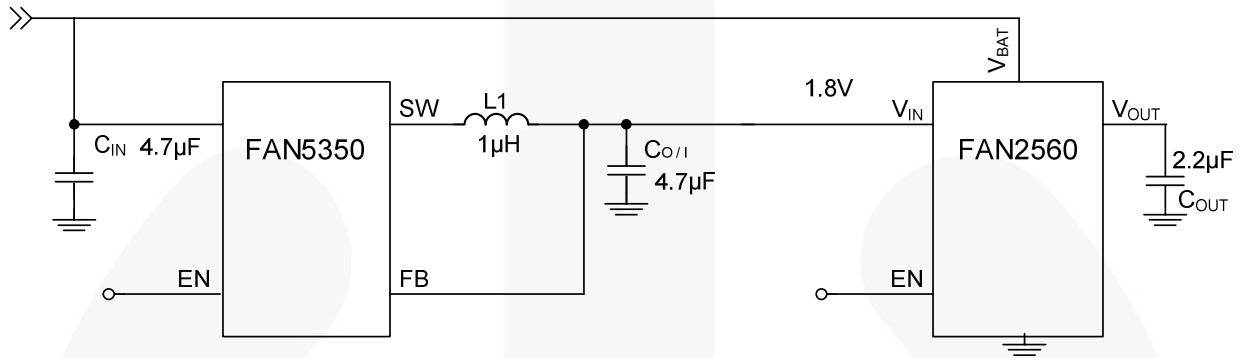

Figure 23. Post Regulator for a Switching Converter

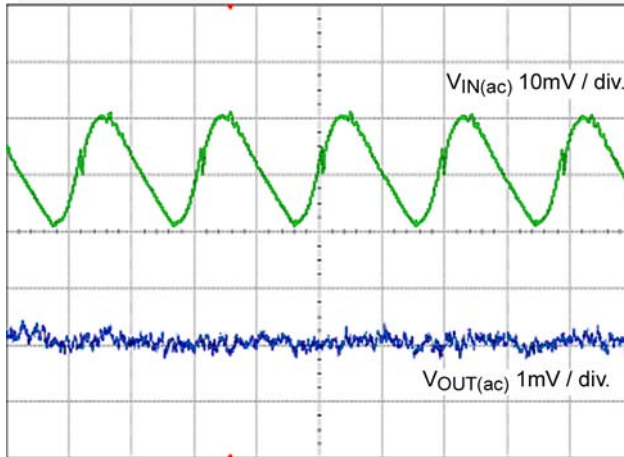

Figure 24. PFM Mode (100mA Load) Buck Ripple Rejection, Horizontal Scale: 500ns/div.

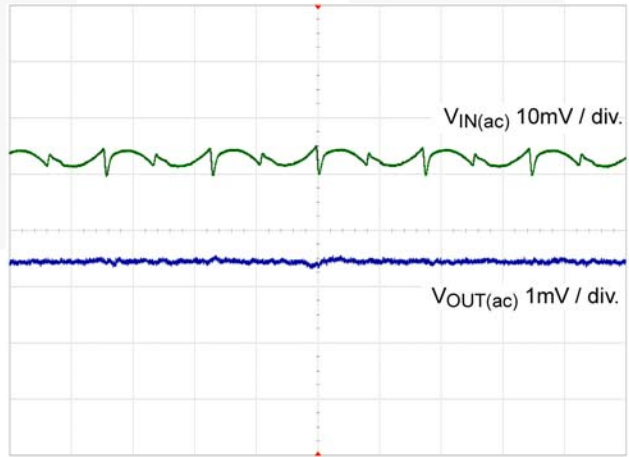

Figure 25. PWM, 3MHz (300mA Load) Buck Ripple Rejection, Horizontal Scale: 200ns/div.

## Physical Dimensions

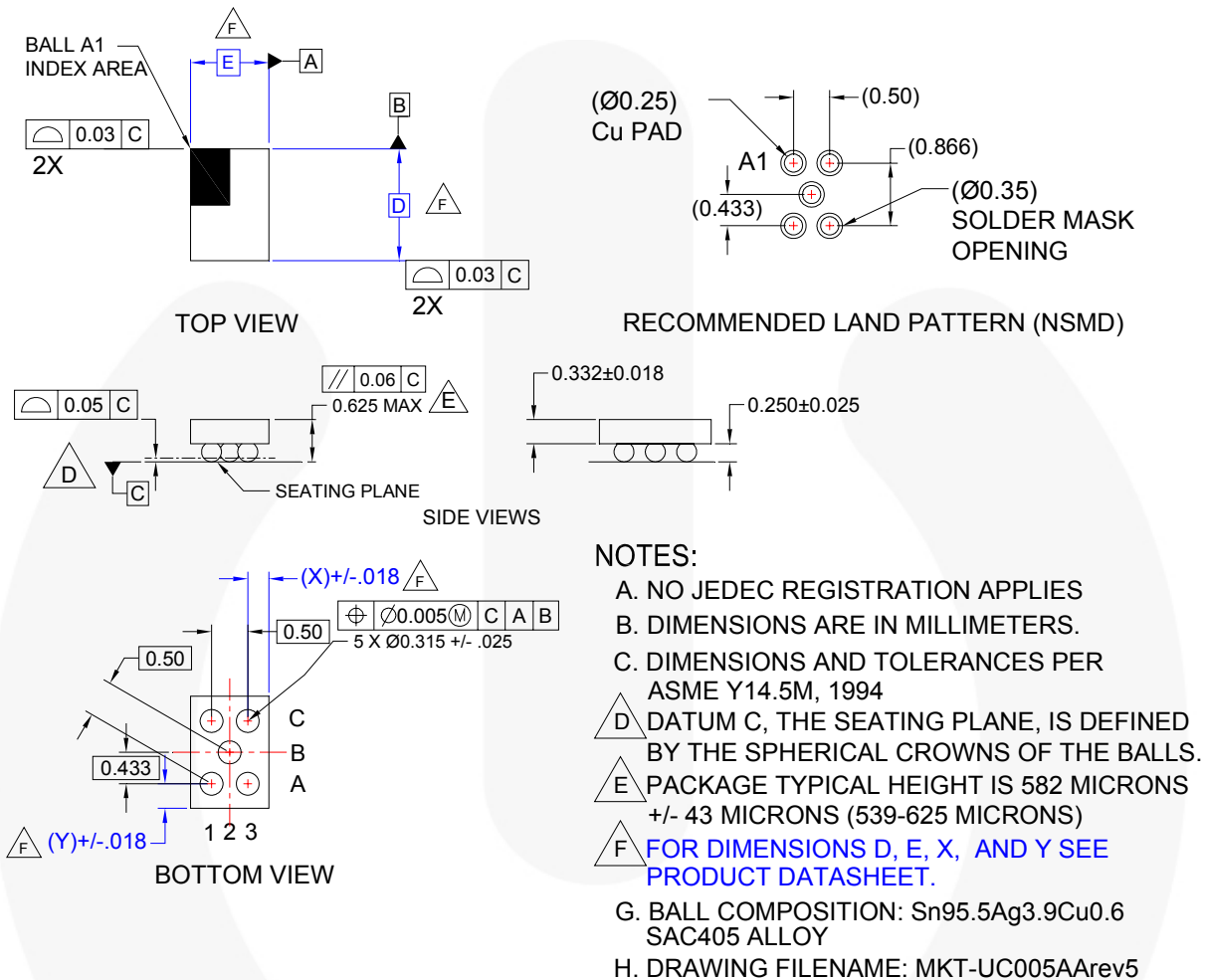

Figure 26. Wafer-Level Chip-Scale Packaging (WLCSPP)

## Product Specific Dimensions

Product	D	E	X	Y
FAN2560UC13X	1.330 +/- 0.030	0.960 +/- 0.030	0.230	0.232
FAN2560UC15X	1.330 +/- 0.030	0.960 +/- 0.030	0.230	0.232







Package drawings are provided as a service to customers considering Fairchild components. Drawings may change in any manner without notice. Please note the revision and/or date on the drawing and contact a Fairchild Semiconductor representative to verify or obtain the most recent revision. Package specifications do not expand the terms of Fairchild's worldwide terms and conditions, specifically the warranty therein, which covers Fairchild products.

Always visit Fairchild Semiconductor's online packaging area for the most recent package drawings:  
<http://www.fairchildsemi.com/packaging/>.



**TRADEMARKS**

The following includes registered and unregistered trademarks and service marks, owned by Fairchild Semiconductor and/or its global subsidiaries, and is not intended to be an exhaustive list of all such trademarks.

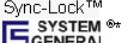
- |   |   |   |   |
|---|---|---|---|
| AccuPower™  | FPST™   | PowerTrench®  | The Power Franchise®  |
| Auto-SPM™   | F-PFST™   | PowerXS™  |  |
| Build it Now™   | FRFET®  | Programmable Active Droop™  | TinyBoost™  |
| CorePLUS™   | Global Power Resource <sup>SM</sup>   | QFET®   | TinyBuck™   |
| CorePOWER™  | Green FPST™   | QS™   | TinyCalc™   |
| CROSSVOLT™  | Green FPST™ e-Series™   | Quiet Series™   | TinyLogic®  |
| CTL™  | Gmax™   | RapidConfigure™   | TINYOPTO™   |
| Current Transfer Logic™   | GTO™  |  | TinyPower™  |
| EcoSPARK®   | IntelliMAX™   | Saving our world, 1mV/VV/kW at a time™  | TinyPWM™  |
| EfficientMax™   | ISOPLANAR™  | SignalWise™   | TinyVire™   |
| EZSWITCH™   | MegaBuck™   | SmartMax™   | TriFault Detect™  |
|  | MICROCOUPLER™   | SMART START™  | TRUECURRENT™  |
|  | MicroFET™   | SPM®  | μSerDes™  |
| Fairchild®  | MicroPak™   | STEALTH™  |  |
| Fairchild Semiconductor®  | MillerDrive™  | SuperFET™   | UHC®  |
| FACT Quiet Series™  | MotionMax™  | SuperSOT™.3   | Ultra FRFET™  |
| FACT®   | Motion-SPM™   | SuperSOT™.6   | UniFET™   |
| FACT®   | OPTOLOGIC®  | SuperSOT™.8   | VCX™  |
| FAST®   | OPTOPLANAR®   | SupreMOS™   | VisualMax™  |
| FastvCore™  |  | SyncFET™  | XST™  |
| FETBench™   | PDP SPM™  | Sync-Lock™  |   |
| FlashWriter®  | Power-SPM™  |  |   |

\* Trademarks of System General Corporation, used under license by Fairchild Semiconductor.

**DISCLAIMER**

FAIRCHILD SEMICONDUCTOR RESERVES THE RIGHT TO MAKE CHANGES WITHOUT FURTHER NOTICE TO ANY PRODUCTS HEREIN TO IMPROVE RELIABILITY, FUNCTION, OR DESIGN. FAIRCHILD DOES NOT ASSUME ANY LIABILITY ARISING OUT OF THE APPLICATION OR USE OF ANY PRODUCT OR CIRCUIT DESCRIBED HEREIN; NEITHER DOES IT CONVEY ANY LICENSE UNDER ITS PATENT RIGHTS, NOR THE RIGHTS OF OTHERS. THESE SPECIFICATIONS DO NOT EXPAND THE TERMS OF FAIRCHILD'S WORLDWIDE TERMS AND CONDITIONS, SPECIFICALLY THE WARRANTY THEREIN, WHICH COVERS THESE PRODUCTS.

**LIFE SUPPORT POLICY**

FAIRCHILD'S PRODUCTS ARE NOT AUTHORIZED FOR USE AS CRITICAL COMPONENTS IN LIFE SUPPORT DEVICES OR SYSTEMS WITHOUT THE EXPRESS WRITTEN APPROVAL OF FAIRCHILD SEMICONDUCTOR CORPORATION.

As used herein:

1. Life support devices or systems are devices or systems which, (a) are intended for surgical implant into the body or (b) support or sustain life, and (c) whose failure to perform when properly used in accordance with instructions for use provided in the labeling, can be reasonably expected to result in a significant injury of the user.
2. A critical component in any component of a life support, device, or system whose failure to perform can be reasonably expected to cause the failure of the life support device or system, or to affect its safety or effectiveness.

**ANTI-COUNTERFEITING POLICY**

Fairchild Semiconductor Corporation's Anti-Counterfeiting Policy. Fairchild's Anti-Counterfeiting Policy is also stated on our external website, [www.fairchildsemi.com](http://www.fairchildsemi.com), under Sales Support.

Counterfeiting of semiconductor parts is a growing problem in the industry. All manufacturers of semiconductor products are experiencing counterfeiting of their parts. Customers who inadvertently purchase counterfeit parts experience many problems such as loss of brand reputation, substandard performance, failed applications, and increased cost of production and manufacturing delays. Fairchild is taking strong measures to protect ourselves and our customers from the proliferation of counterfeit parts. Fairchild strongly encourages customers to purchase Fairchild parts either directly from Fairchild or from Authorized Fairchild Distributors who are listed by country on our web page cited above. Products customers buy either from Fairchild directly or from Authorized Fairchild Distributors are genuine parts, have full traceability, meet Fairchild's quality standards for handling and storage and provide access to Fairchild's full range of up-to-date technical and product information. Fairchild and our Authorized Distributors will stand behind all warranties and will appropriately address any warranty issues that may arise. Fairchild will not provide any warranty coverage or other assistance for parts bought from Unauthorized Sources. Fairchild is committed to combat this global problem and encourage our customers to do their part in stopping this practice by buying direct or from authorized distributors.

**PRODUCT STATUS DEFINITIONS**

**Definition of Terms**

Datasheet Identification	Product Status	Definition
Advance Information	Formative / In Design	Datasheet contains the design specifications for product development. Specifications may change in any manner without notice.
Preliminary	First Production	Datasheet contains preliminary data; supplementary data will be published at a later date. Fairchild Semiconductor reserves the right to make changes at any time without notice to improve design.
No Identification Needed	Full Production	Datasheet contains final specifications. Fairchild Semiconductor reserves the right to make changes at any time without notice to improve the design.
Obsolete	Not In Production	Datasheet contains specifications on a product that is discontinued by Fairchild Semiconductor. The datasheet is for reference information only.

Rev. I42