

## DS9636A RS-423 Dual Programmable Slew Rate Line Driver

### General Description

The DS9636A is a TTL/CMOS compatible, dual, single ended line driver which has been specifically designed to satisfy the requirements of EIA Standard RS-423.

The DS9636A is suitable for use in digital data transmission systems where signal wave shaping is desired. The output slew rates are jointly controlled by a single external resistor connected between the wave shaping control lead (WS) and ground. This eliminates any need for external filtering of the output signals. Output voltage levels and slew rates are independent of power supply variations. Current-limiting is provided in both output states. The DS9636A is designed for nominal power supplies of  $\pm 12V$ .

Inputs are TTL compatible with input current loading low enough ( $1/10$  UL) to be also compatible with CMOS logic. Clamp diodes are provided on the inputs to limit transients below ground.

### Features

- Programmable slew rate limiting
- Meets EIA Standard RS-423
- Commercial or extended temperature range
- Output short circuit protection
- TTL and CMOS compatible inputs

### Connection Diagram

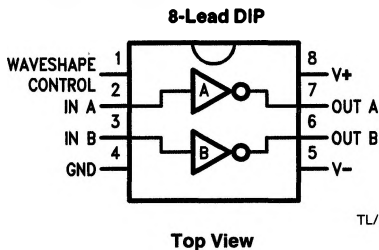

**Order Number DS9636ACJ,  
DS9636ACN or DS9636AMJ  
See NS Package Number J08A or N08E  
For Complete Military 883 Specifications,  
see RETS Data Sheet.**

**Order Number DS9636AJ/883  
See NS Package Number J08A**

**Absolute Maximum Ratings** (Note 1)

If Military/Aerospace specified devices are required, please contact the National Semiconductor Sales Office/Distributors for availability and specifications.

## Storage Temperature Range

Ceramic DIP	-65°C to +175°C
Molded DIP	-65°C to +150°C

## Lead Temperature

Ceramic DIP (Soldering, 60 seconds)	300°C
Molded DIP (Soldering, 10 seconds)	265°C

## Maximum Power Dissipation\* at 25°C (Note 5)

Cavity Package	1560 mW
Molded Package	1300 mW
V+ Lead Potential to Ground Lead	V- to +15V
V- Lead Potential to Ground Lead	+0.5V to -15V
V+ Lead Potential to V- Lead	0V to +30V
Output Potential to Ground Lead	±15V
Output Source Current	-150 mA
Output Sink Current	150 mA

**Recommended Operating Conditions**

Characteristics	DS9636AM			DS9636AC			Units
	Min	Typ	Max	Min	Typ	Max	
Positive Supply Voltage (V+)	10.8	12	13.2	10.8	12	13.2	V
Negative Supply Voltage (V-)	-13.2	-12	-10.8	-13.2	-12	-10.8	V
Operating Temperature (T <sub>A</sub> )	-55	25	125	0	25	70	°C
Wave Shaping Resistance (R <sub>WS</sub> )	10		500	10		1000	kΩ

**Electrical Characteristics** Over recommended operating temperature, supply voltage and wave shaping resistance ranges unless otherwise specified (Notes 2 and 3)

Symbol	Parameter	Conditions	Min	Typ	Max	Units
V <sub>OH1</sub>	Output Voltage HIGH	R <sub>L</sub> to GND (R <sub>L</sub> = ∞)	5.0	5.6	6.0	V
V <sub>OH2</sub>		R <sub>L</sub> to GND (R <sub>L</sub> = 3.0 kΩ)	5.0	5.6	6.0	V
V <sub>OH3</sub>		R <sub>L</sub> to GND (R <sub>L</sub> = 450Ω)	4.0	5.5	6.0	V
V <sub>OL1</sub>	Output Voltage LOW	R <sub>L</sub> to GND (R <sub>L</sub> = ∞)	-6.0	-5.7	-5.0	V
V <sub>OL2</sub>		R <sub>L</sub> to GND (R <sub>L</sub> = 3.0 kΩ)	-6.0	-5.6	-5.0	V
V <sub>OL3</sub>		R <sub>L</sub> to GND (R <sub>L</sub> = 450Ω)	-6.0	-5.4	-4.0	V
R <sub>O</sub>	Output Resistance	450Ω ≤ R <sub>L</sub>		25	50	Ω
I <sub>OS+</sub>	Output Short Circuit Current (Note 4)	V <sub>O</sub> = 0V, V <sub>I</sub> = 0V	-150	-60	-15	mA
I <sub>OS-</sub>		V <sub>O</sub> = 0V, V <sub>I</sub> = 2.0V	15	60	150	mA
I <sub>CEX</sub>	Output Leakage Current	V <sub>O</sub> = ±6.0V, Power-Off	-100		+100	μA
V <sub>IH</sub>	Input Voltage HIGH		2.0			V
V <sub>IL</sub>	Input Voltage LOW				0.8	V
V <sub>IC</sub>	Input Clamp Diode Voltage	I <sub>I</sub> = 15 mA	-1.5	-1.1		V
I <sub>IL</sub>	Input Current LOW	V <sub>I</sub> = 0.4V	-80	-16		V
I <sub>IH</sub>	Input Current HIGH	V <sub>I</sub> = 2.4V		1.0	10	μA
		V <sub>I</sub> = 5.5V			10	
I+	Positive Supply Current	V <sub>CC</sub> = ±12V, R <sub>L</sub> = ∞, R <sub>WS</sub> = 100 kΩ, V <sub>I</sub> = 0V		13	18	mA
I-	Negative Supply Current	V <sub>CC</sub> = ±12V, R <sub>L</sub> = ∞, R <sub>WS</sub> = 100 kΩ, V <sub>I</sub> = 0V	-18	-13		mA

**Note 1:** "Absolute Maximum Ratings" are those values beyond which the safety of the device cannot be guaranteed. They are not meant to imply that the devices should be operated at these limits. The tables of "Electrical Characteristics" provide conditions for actual device operation.

**Note 2:** Unless otherwise specified Min/Max limits apply across the -55°C to +125°C temperature range for the DS9636AM and across the 0°C to +70°C range for the DS9636AC. All typicals are given for V<sub>CC</sub> = 5V and T<sub>A</sub> = 25°C.

**Note 3:** All currents into the device pins are positive; all currents out of the device pins are negative. All voltages are reference to ground unless otherwise specified.

**Note 4:** Only one output at a time should be shorted.

**Note 5:** Ratings apply to ambient temperature at 25°C. Above this temperature, derate J and N packages 10.4 mW/°C.

**Switching Characteristics**  $V_{CC} = \pm 12V \pm 10\%$ ,  $T_A = 25^\circ C$ , see AC Test Circuit

Symbol	Parameter	Condition	Min	Typ	Max	Units
$t_r$	Rise Time	$R_{WS} = 10\text{ k}\Omega$	0.8	1.1	1.4	$\mu s$
		$R_{WS} = 100\text{ k}\Omega$	8.0	11	14	
		$R_{WS} = 500\text{ k}\Omega$	40	55	70	
		$R_{WS} = 1000\text{ k}\Omega$	80	110	140	
$t_f$	Fall Time	$R_{WS} = 10\text{ k}\Omega$	0.8	1.1	1.4	$\mu s$
		$R_{WS} = 100\text{ k}\Omega$	8.0	11	14	
		$R_{WS} = 500\text{ k}\Omega$	40	55	70	
		$R_{WS} = 1000\text{ k}\Omega$	80	110	140	

# Typical Performance Characteristics

**Input/Output Transfer Characteristic vs Temperature**

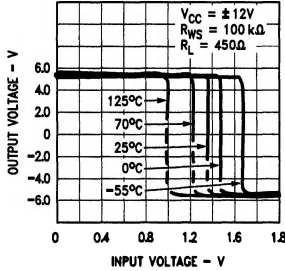

**Input Current vs Input Voltage**

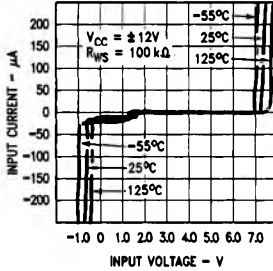

**Output Current vs Output Voltage (Power On)**

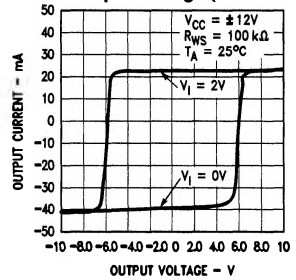

**Output Current vs Output Voltage (Power Off)**

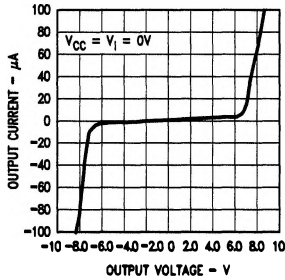

**Supply Current vs Temperature**

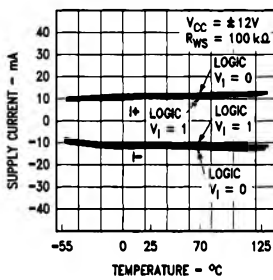

**Transition Time vs RWS**

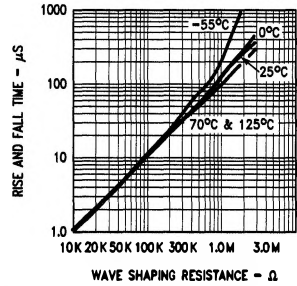

TL/F/9620-3

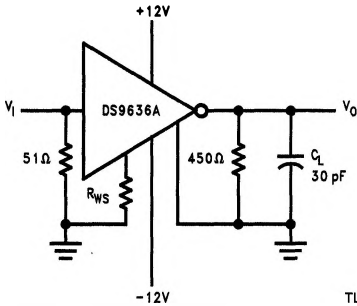

TL/F/9620-4

Note:  $C_L$  includes jig and probe capacitance

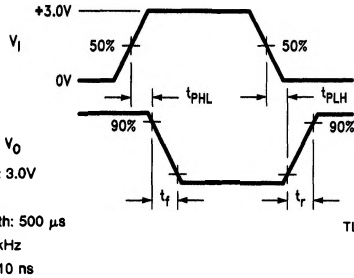

TL/F/9620-5

**FIGURE 1. AC Test Circuit and Waveforms**

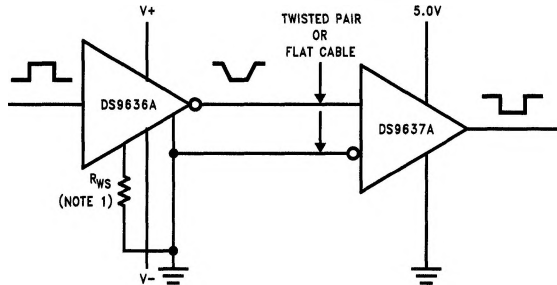

**FIGURE 2. RS-423 System Application**

TL/F/9620-6