

DS7831,DS8832

DS7831/DS8832 Dual TRI-STATE Line Driver



Literature Number: SNLS361A

DS7831/DS8832

Dual TRI-STATE® Line Driver

General Description

Through simple logic control, the DS7831/DS8832 can be used as either a quad single-ended line driver or a dual differential line driver. They are specifically designed for party line (bus-organized) systems. The DS8832 does not have the V_{CC} clamp diodes found on the DS7831.

The DS7831 is specified for operation over the -55°C to $+125^{\circ}\text{C}$ military temperature range. The DS8832 is specified for operation over the 0°C to $+70^{\circ}\text{C}$ temperature range.

Features

- Series 54/74 compatible
- 17 ns propagation delay
- Very low output impedance—high drive capability
- 40 mA sink and source currents
- Gating control to allow either single-ended or differential operation
- High impedance output state which allows many outputs to be connected to a common bus line

Connection and Logic Diagram

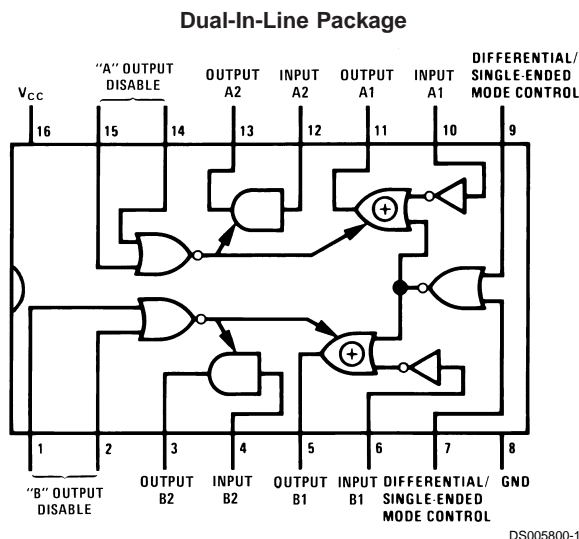

Top View

Order Number DS8832J or DS8832N
See NS Package Number J16A or N16A
For Complete Military 883 Specifications,
See RETS Data Sheet.
Order Number DS7831J/883, DS7831W/883,
See NS Package Number J16A or W16A

Truth Table

(Shown for A Channels Only)

"A" Output Disable		Differential/ Single-Ended Mode Control		Input A1	Output A1	Input A2	Output A2
0	0	0	0	Logical "1" or Logical "0"	Same as Input A1	Logical "1" or Logical "0"	Same as Input A2
0	0	X 1	1 X	Logical "1" or Logical "0"	Opposite of Input A1	Logical "1" or Logical "0"	Same as Input A2
1 X	X 1	X	X	X	High Impedance State	X	High Impedance State

X = Don't Care

Absolute Maximum Ratings (Note 2)

If Military/Aerospace specified devices are required, please contact the National Semiconductor Sales Office/Distributors for availability and specifications.

Supply Voltage	7V
Input Voltage	5.5V
Output Voltage	5.5V
Storage Temperature Range	-65°C to +150°C
Lead Temperature (Soldering, 4 sec.)	260°C
Maximum Power Dissipation (Note 1) at 25°C	
Cavity Package	1433 mW
Molded Package	1362 mW

Operating Conditions

	Min	Max	Units
Supply Voltage (V_{CC})			
DS7831	4.5	5.5	V
DS8831/DS8832	4.75	5.25	V
Temperature (T_A)			
DS7831	-55	+125	°C
DS8832	0	+70	°C

Note 1: Derate cavity package 9.6 mW/°C above 25°C; derate molded package 10.9 mW/°C above 25°C.

Electrical Characteristics (Notes 3, 4)

Symbol	Parameter	Conditions		Min	Typ	Max	Units	
V_{IH}	Logical "1" Input Voltage	$V_{CC} = \text{Min}$		2.0			V	
V_{IL}	Logical "0" Input Voltage	$V_{CC} = \text{Min}$				0.8	V	
V_{OH}	Logical "1" Output Voltage	DS7831	$V_{CC} = \text{Min}$	$I_O = -40 \text{ mA}$	1.8	2.3	V	
				$I_O = -2 \text{ mA}$	2.4	2.7	V	
		DS8832		$I_O = -40 \text{ mA}$	1.8	2.5	V	
				$I_O = -5.2 \text{ mA}$	2.4	2.9	V	
V_{OL}	Logical "0" Output Voltage	DS7831	$V_{CC} = \text{Min}$	$I_O = 40 \text{ mA}$		0.29	0.50	V
				$I_O = 32 \text{ mA}$			0.40	V
		DS8832		$I_O = 40 \text{ mA}$		0.29	0.50	V
				$I_O = 32 \text{ mA}$			0.40	V
I_{IH}	Logical "1" Input Current	$V_{CC} = \text{Max}$	DS7831, $V_{IN} = 5.5V$			1	mA	
			DS8832, $V_{IN} = 2.4V$			40	µA	
I_{IL}	Logical "0" Input Current	$V_{CC} = \text{Max}$, $V_{IN} = 0.4V$			-1.0	-1.6	mA	
I_{OD}	Output Disable Current	$V_{CC} = \text{Max}$, $V_O = 2.4V$ or $0.4V$		-40		40	µA	
I_{SC}	Output Short Circuit Current	$V_{CC} = \text{Max}$, (Note 5)		-40	-100	-120	mA	
I_{CC}	Supply Current	$V_{CC} = \text{Max}$ in TRI-STATE			65	90	mA	
V_{CLI}	Input Diode Clamp Voltage	$V_{CC} = 5.0V$, $T_A = 25^\circ\text{C}$, $I_{IN} = -12 \text{ mA}$				-1.5	V	
V_{CLO}	Output Diode Clamp Voltage	$V_{CC} = 5.0V$, $T_A = 25^\circ\text{C}$	$I_{OUT} = -12 \text{ mA}$	DS7831		-1.5	V	
			$I_{OUT} = 12 \text{ mA}$	DS8832				
						$V_{CC} + 1.5$	V	

Switching Characteristics

$T_A = 25^\circ\text{C}$, $V_{CC} = 5V$, unless otherwise noted

Symbol	Parameter	Conditions	Min	Typ	Max	Units
t_{pd0}	Propagation Delay to a Logical "0" from Inputs A1, A2, B1, B2 Differential Single-ended Mode Control to Outputs	(See Figure 4 and Figure 5)		13	25	ns
t_{pd1}	Propagation Delay to a Logical "1" from Inputs A1, A2, B1, B2 Differential Single-ended Mode Control to Outputs			13	25	ns
t_{1H}	Delay from Disable Inputs to High Impedance State (from Logical "1" Level)			6	12	ns
t_{0H}	Delay from Disable Inputs to High Impedance State (from Logical "0" Level)			14	22	ns

Switching Characteristics (Continued)

$T_A = 25^\circ\text{C}$, $V_{CC} = 5\text{V}$, unless otherwise noted

Symbol	Parameter	Conditions	Min	Typ	Max	Units
t_{H1}	Propagation Delay from Disable Inputs to Logical "1" Level (from High Impedance State)			14	22	ns
t_{H0}	Propagation Delay from Disable Inputs to Logical "0" Level (from High Impedance State)			18	27	ns

Note 2: "Absolute Maximum Ratings" are those values beyond which the safety of the device cannot be guaranteed. Except for "Operating Temperature Range" they are not meant to imply that the devices should be operated at these limits. The table of "Electrical Characteristics" provides conditions for actual device operation.

Note 3: Unless otherwise specified min/max limits apply across the -55°C to $+125^\circ\text{C}$ temperature range for the DS7831 and across the 0°C to $+70^\circ\text{C}$ range for the DS8832. All typical values are for $T_A = 25^\circ\text{C}$ and $V_{CC} = 5\text{V}$.

Note 4: All currents into device pins shown as positive, out of device pins as negative, all voltage referenced to ground unless otherwise noted. All values shown as max or min on absolute value basis.

Note 5: Applies for $T_A = 125^\circ\text{C}$ only. Only one output should be shorted at a time.

Mode of Operation

To operate as a quad single-ended line driver apply logical "0"s to the output disable pins (to keep the outputs in the normal low impedance mode) and apply logical "0"s to both Differential/Single-ended Mode Control inputs. All four channels will then operate independently and no signal inversion will occur between inputs and outputs.

To operate as a dual differential line driver apply logical "0"s to the Output Disable pins and apply at least one logical "1" to the Differential/Single-ended Mode Control inputs.

The inputs to the A channels should be connected together and the inputs to the B channels should be connected together.

In this mode the signals applied to the resulting inputs will pass non-inverted on the A_2 and B_2 outputs and inverted on the A_1 and B_1 outputs.

When operating in a bus-organized system with outputs tied directly to outputs of other DS7831, DS8832's (Figure 1), all devices except one must be placed in the "high impedance" state. This is accomplished by ensuring that a logical "1" is

applied to at least one of the Output Disable pins of each device which is to be in the "high impedance" state. A NOR gate was purposely chosen for this function since it is possible with only two DM5442/DM7442, BCD-to-decimal decoders, to decode as many as 100 DS7831, DS8832's (Figure 2).

The unique device whose Disable inputs receive two logical "0" levels assumes the normal low impedance output state, providing good capacitive drive capability and waveform integrity especially during the transition from the logical "0" to logical "1" state. The other outputs—in the high impedance state—take only a small amount of leakage current from the low impedance outputs. Since the logical "1" output current from the selected device is 100 times that of a conventional Series 54/74 device (40 mA vs. 400 μA), the output is easily able to supply that leakage current for several hundred other DS7831/DS8831's, DS7832/DS8832's and still have available drive for the bus line (Figure 3).

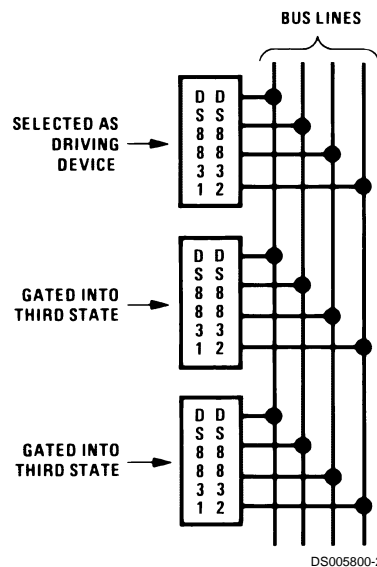
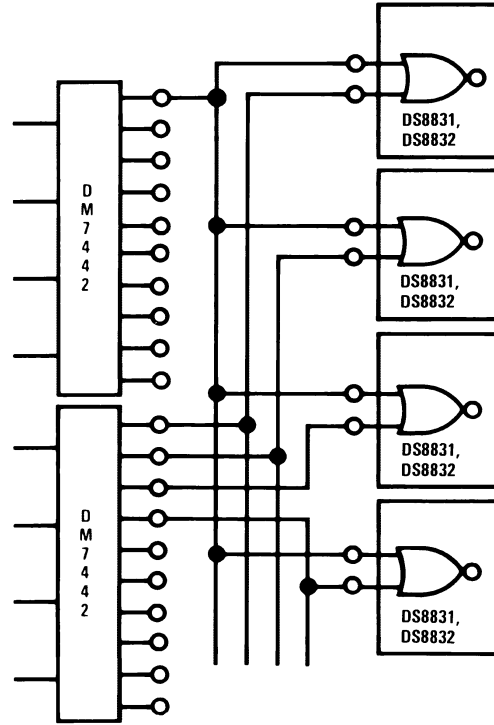

FIGURE 1.

Mode of Operation (Continued)



DS005800-3

FIGURE 2.

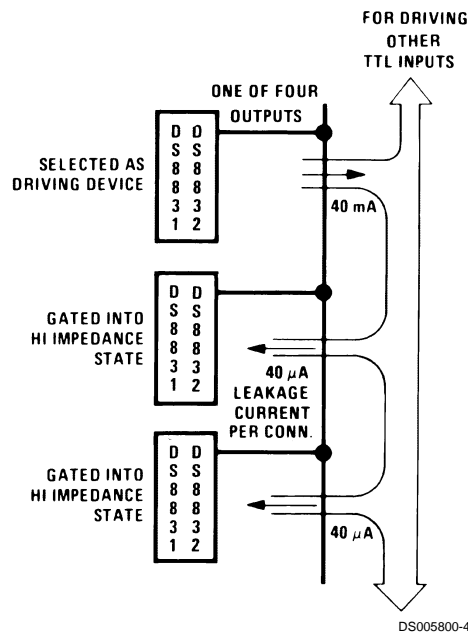

DS005800-4

FIGURE 3.

Typical Performance Characteristics

Propagation Delay from Input to Output (Channel 1)

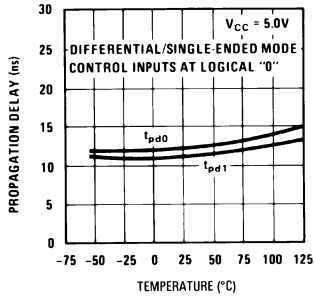

DS005800-5

Propagation Delay from Input to Output (Channel 1)

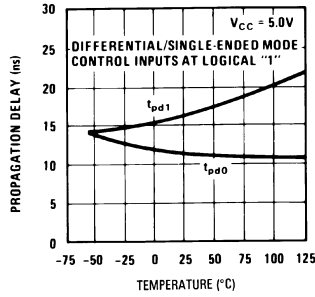

DS005800-10

Propagation Delay from Input to Output (Channel 2)

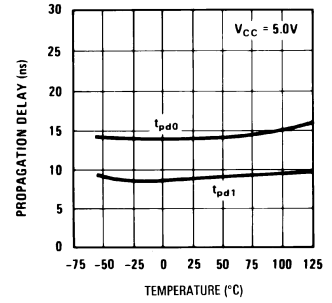

DS005800-11

Delay from Disable to High Impedance State

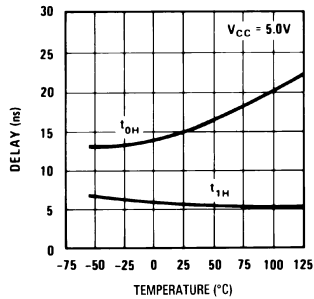

DS005800-12

Delay from Disable to Low Impedance State

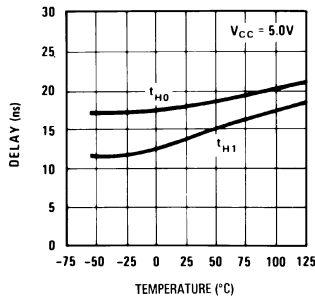

DS005800-13

Propagation Delay vs Load Capacitance

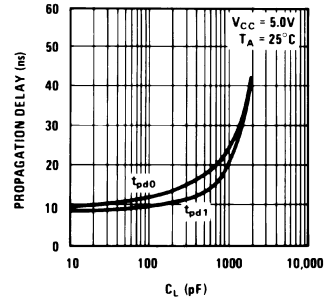

DS005800-14

Total Supply Current vs Frequency

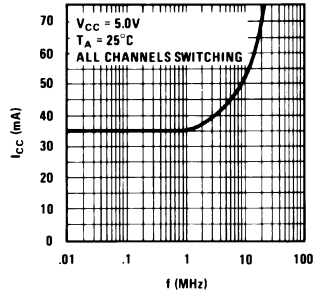

DS005800-15

Logical "1" Output Voltage vs Source Current

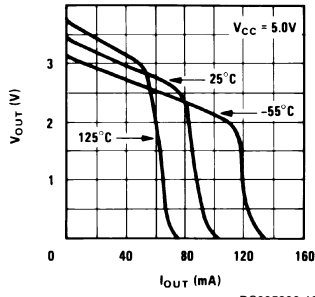

DS005800-16

Logical "0" Output Voltage vs Sink Current

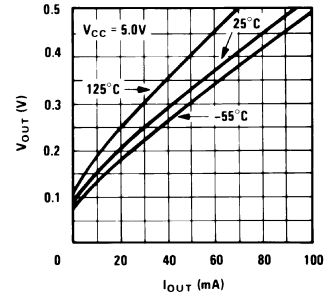

DS005800-17

I_{OUT} vs V_{OUT} High Impedance Output State

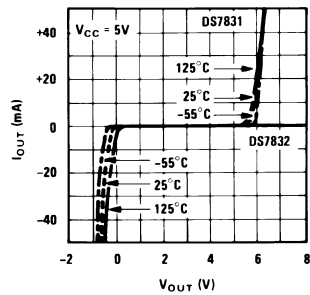

DS005800-18

Propagation Delay in Differential Mode

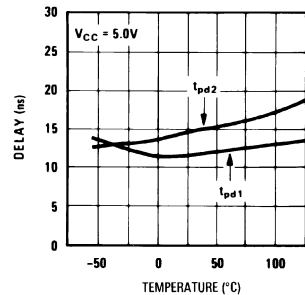

DS005800-19

Typical Performance Characteristics (Continued)

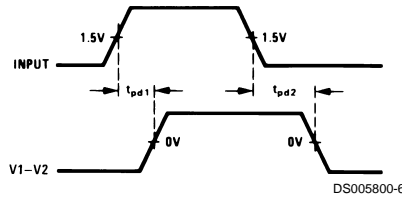
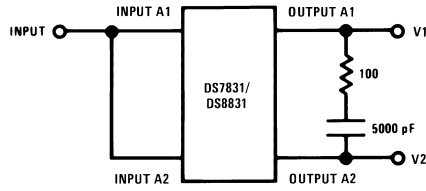

Switching Time Waveforms

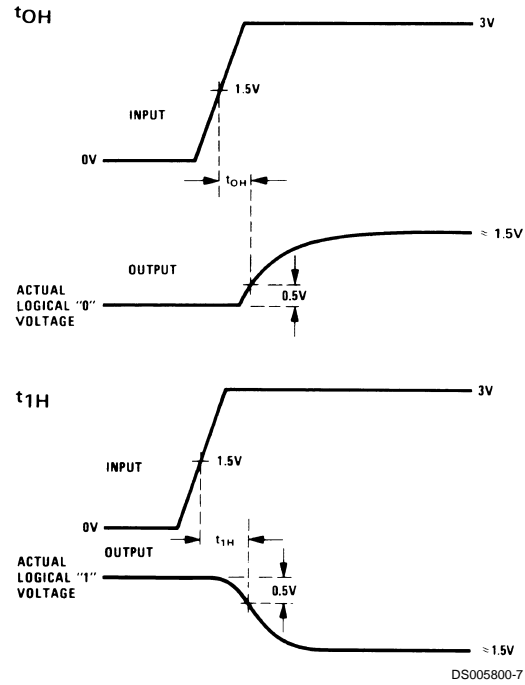
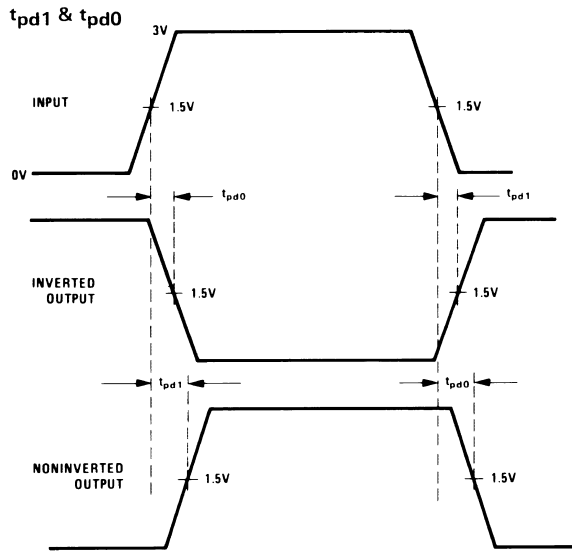

Input characteristic:
 Amplitude = 3.0V
 Frequency = 1.0 MHz, 50% duty cycle
 $t_r = t_f \leq ns$ (10% to 90%)

Switching Time Waveforms (Continued)

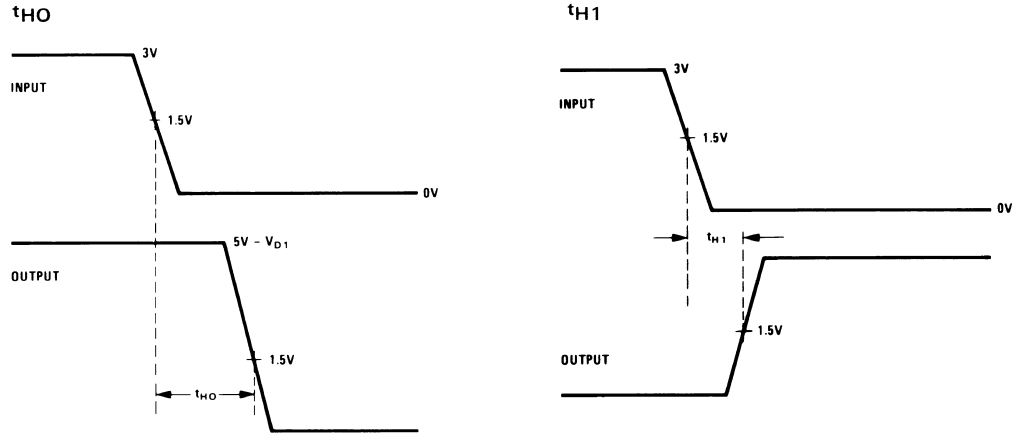
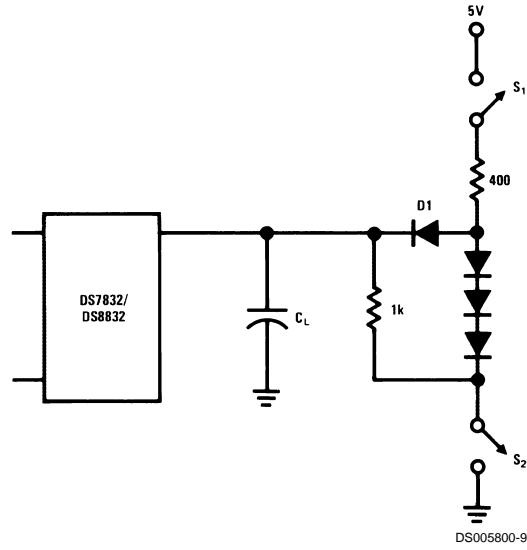

FIGURE 4.

DS005800-8

AC Load Circuit



Symbol	Switch S1	Switch S2	C_L
t_{pd1}	closed	closed	50 pF
t_{pd0}	closed	closed	50 pF
t_{0H}	closed	closed	*5 pF
t_{1H}	closed	closed	*5 pF
t_{H0}	closed	open	50 pF
t_{H1}	open	closed	50 pF

*Jig capacitance

FIGURE 5.

Physical Dimensions inches (millimeters) unless otherwise noted

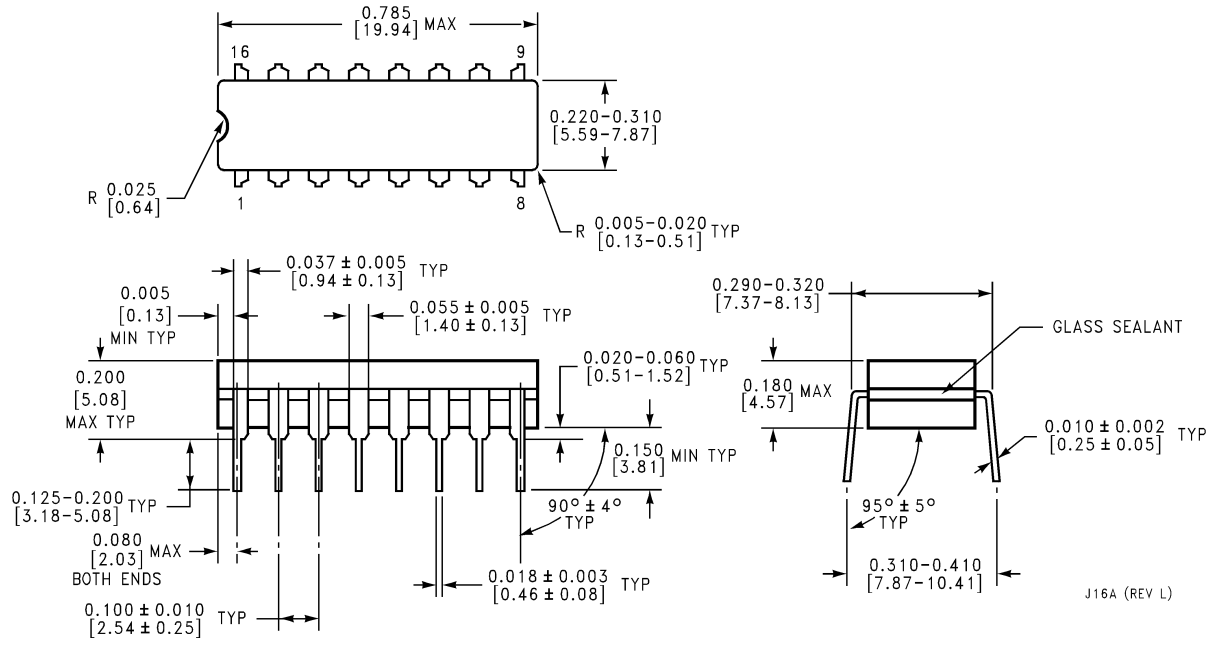

J16A (REV L)

Ceramic Dual-In-Line Package (J)
Order Number DS7831J or DS8832J
NS Package Number J16A

Physical Dimensions inches (millimeters) unless otherwise noted (Continued)

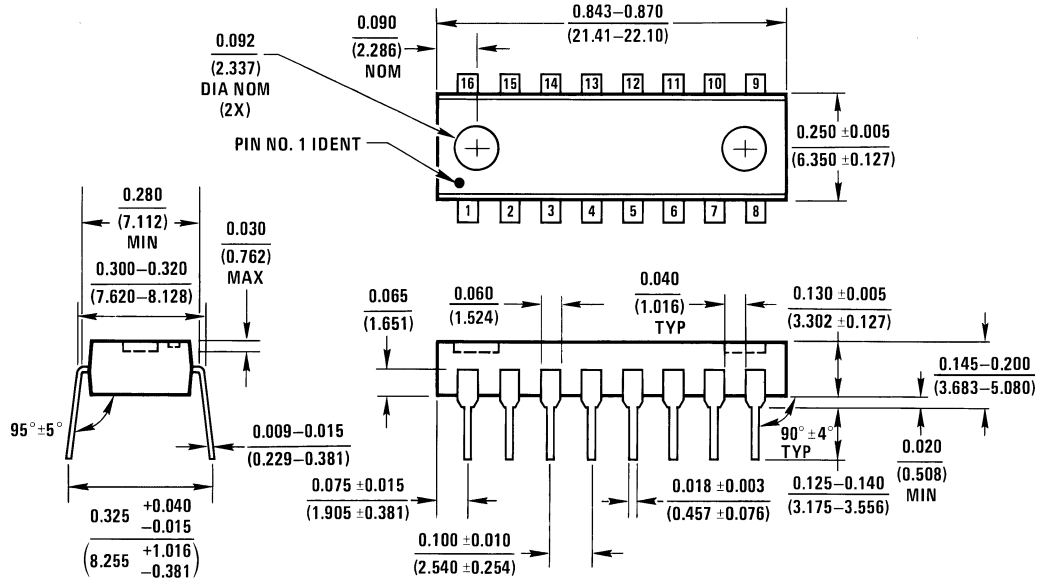

N16A (REV E)

Molded Dual-In-Line Package (N)
Order Number DS8832N
NS Package Number N16A

LIFE SUPPORT POLICY

NATIONAL'S PRODUCTS ARE NOT AUTHORIZED FOR USE AS CRITICAL COMPONENTS IN LIFE SUPPORT DEVICES OR SYSTEMS WITHOUT THE EXPRESS WRITTEN APPROVAL OF THE PRESIDENT AND GENERAL COUNSEL OF NATIONAL SEMICONDUCTOR CORPORATION. As used herein:

1. Life support devices or systems are devices or systems which, (a) are intended for surgical implant into the body, or (b) support or sustain life, and whose failure to perform when properly used in accordance with instructions for use provided in the labeling, can be reasonably expected to result in a significant injury to the user.
2. A critical component is any component of a life support device or system whose failure to perform can be reasonably expected to cause the failure of the life support device or system, or to affect its safety or effectiveness.



National Semiconductor Corporation
 Americas
 Email: support@nsc.com

National Semiconductor Europe
 Fax: +49 (0) 180-530 85 86
 Email: europe.support@nsc.com
 Deutsch Tel: +49 (0) 69 9508 6208
 English Tel: +44 (0) 870 24 0 2171
 Français Tel: +33 (0) 1 41 91 8790

National Semiconductor Asia Pacific Customer Response Group
 Tel: 65-2544466
 Fax: 65-2504466
 Email: ap.support@nsc.com

National Semiconductor Japan Ltd.
 Tel: 81-3-5639-7560
 Fax: 81-3-5639-7507

www.national.com

IMPORTANT NOTICE

Texas Instruments Incorporated and its subsidiaries (TI) reserve the right to make corrections, modifications, enhancements, improvements, and other changes to its products and services at any time and to discontinue any product or service without notice. Customers should obtain the latest relevant information before placing orders and should verify that such information is current and complete. All products are sold subject to TI's terms and conditions of sale supplied at the time of order acknowledgment.

TI warrants performance of its hardware products to the specifications applicable at the time of sale in accordance with TI's standard warranty. Testing and other quality control techniques are used to the extent TI deems necessary to support this warranty. Except where mandated by government requirements, testing of all parameters of each product is not necessarily performed.

TI assumes no liability for applications assistance or customer product design. Customers are responsible for their products and applications using TI components. To minimize the risks associated with customer products and applications, customers should provide adequate design and operating safeguards.

TI does not warrant or represent that any license, either express or implied, is granted under any TI patent right, copyright, mask work right, or other TI intellectual property right relating to any combination, machine, or process in which TI products or services are used. Information published by TI regarding third-party products or services does not constitute a license from TI to use such products or services or a warranty or endorsement thereof. Use of such information may require a license from a third party under the patents or other intellectual property of the third party, or a license from TI under the patents or other intellectual property of TI.

Reproduction of TI information in TI data books or data sheets is permissible only if reproduction is without alteration and is accompanied by all associated warranties, conditions, limitations, and notices. Reproduction of this information with alteration is an unfair and deceptive business practice. TI is not responsible or liable for such altered documentation. Information of third parties may be subject to additional restrictions.

Resale of TI products or services with statements different from or beyond the parameters stated by TI for that product or service voids all express and any implied warranties for the associated TI product or service and is an unfair and deceptive business practice. TI is not responsible or liable for any such statements.

TI products are not authorized for use in safety-critical applications (such as life support) where a failure of the TI product would reasonably be expected to cause severe personal injury or death, unless officers of the parties have executed an agreement specifically governing such use. Buyers represent that they have all necessary expertise in the safety and regulatory ramifications of their applications, and acknowledge and agree that they are solely responsible for all legal, regulatory and safety-related requirements concerning their products and any use of TI products in such safety-critical applications, notwithstanding any applications-related information or support that may be provided by TI. Further, Buyers must fully indemnify TI and its representatives against any damages arising out of the use of TI products in such safety-critical applications.

TI products are neither designed nor intended for use in military/aerospace applications or environments unless the TI products are specifically designated by TI as military-grade or "enhanced plastic." Only products designated by TI as military-grade meet military specifications. Buyers acknowledge and agree that any such use of TI products which TI has not designated as military-grade is solely at the Buyer's risk, and that they are solely responsible for compliance with all legal and regulatory requirements in connection with such use.

TI products are neither designed nor intended for use in automotive applications or environments unless the specific TI products are designated by TI as compliant with ISO/TS 16949 requirements. Buyers acknowledge and agree that, if they use any non-designated products in automotive applications, TI will not be responsible for any failure to meet such requirements.

Following are URLs where you can obtain information on other Texas Instruments products and application solutions:

Products

Audio	www.ti.com/audio
Amplifiers	amplifier.ti.com
Data Converters	dataconverter.ti.com
DLP® Products	www.dlp.com
DSP	dsp.ti.com
Clocks and Timers	www.ti.com/clocks
Interface	interface.ti.com
Logic	logic.ti.com
Power Mgmt	power.ti.com
Microcontrollers	microcontroller.ti.com
RFID	www.ti-rfid.com
OMAP Mobile Processors	www.ti.com/omap
Wireless Connectivity	www.ti.com/wirelessconnectivity

Applications

Communications and Telecom	www.ti.com/communications
Computers and Peripherals	www.ti.com/computers
Consumer Electronics	www.ti.com/consumer-apps
Energy and Lighting	www.ti.com/energy
Industrial	www.ti.com/industrial
Medical	www.ti.com/medical
Security	www.ti.com/security
Space, Avionics and Defense	www.ti.com/space-avionics-defense
Transportation and Automotive	www.ti.com/automotive
Video and Imaging	www.ti.com/video

TI E2E Community Home Page

e2e.ti.com

Mailing Address: Texas Instruments, Post Office Box 655303, Dallas, Texas 75265
Copyright © 2011, Texas Instruments Incorporated