

DS7820A,DS8820A

DS7820A/DS8820A Dual Line Receiver



Literature Number: SNLS358A

DS7820A/DS8820A Dual Line Receiver

General Description

The DS7820A and the DS8820A are improved performance digital line receivers with two completely independent units fabricated on a single silicon chip. Intended for use with digital systems connected by twisted pair lines, they have a differential input designed to reject large common mode signals while responding to small differential signals. The output is directly compatible with TTL or LS integrated circuits.

The response time can be controlled with an external capacitor to reject input noise spikes. The output state is a logic "1" for both inputs open. Termination resistors for the twisted pair line are also included in the circuit. Both the DS7820A and the DS8820A are specified, worst case, over their full

operating temperature range (-55°C to $+125^{\circ}\text{C}$ and 0°C to 70°C respectively), over the entire input voltage range, for $\pm 10\%$ supply voltage variations.

Features

- Operation from a single +5V logic supply
- Input voltage range of $\pm 15\text{V}$
- Strobe low forces output to "1" state
- High input resistance
- Fanout of ten with TTL integrated circuits
- Outputs can be wire OR'ed
- Series 54/74 compatible

Connection Diagram

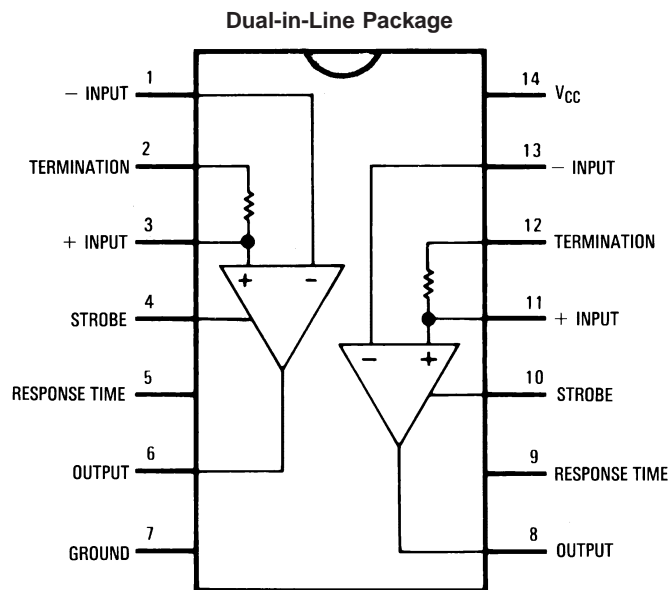

DS005797-2

Note 1: Pin 7 connected to bottom of cavity package.

Top View

Order Number DS7820AJ or DS8820AN See NS Package Number J14A or N14A

For Complete Military 883 Specifications, See RETS Data Sheet.

Order Number DS7820AJ/883

See NS Package Number J14A or W14B

Absolute Maximum Ratings (Note 3)

If Military/Aerospace specified devices are required, please contact the National Semiconductor Sales Office/Distributors for availability and specifications.

Supply Voltage	8.0V
Common-Mode Voltage	±20V
Differential Input Voltage	±20V
Strobe Voltage	8.0V
Output Sink Current	50 mA
Storage Temperature Range	-65°C to 150°C
Maximum Power Dissipation (Note 2) at 25°C	
Cavity Package	1308 mW
Molded Package	1207 mW

Lead Temperature (Soldering, 4 sec.)

260°C

Operating Conditions

	Min	Max	Units
Supply Voltage (V_{CC})			
DS7820A	4.5	5.5	V
DS8820A	4.75	5.25	V
Temperature (T_A)			
DS7820A	-55	+125	°C
DS8820A	0	+70	°C

Note 2: Derate cavity package 8.7 mW/°C above 25°C; derate molded package 9.7 mW/°C above 25°C.

Electrical Characteristics (Notes 4, 5, 6)

Symbol	Parameter	Conditions	Min	Typ	Max	Units	
V_{TH}	Differential Threshold Voltage	$I_{OUT} = -400 \mu A$, $V_{OUT} \geq 2.5V$	$-3V \leq V_{CM} \leq +3V$		0.06	0.5	V
			$-15V \leq V_{CM} \leq +15V$		0.06	1.0	V
		$I_{OUT} = +16 mA$, $V_{OUT} \leq 0.4V$	$-3V \leq V_{CM} \leq +3V$		-0.08	-0.5	V
			$-15V \leq V_{CM} \leq +15V$		-0.08	-1.0	V
R_{I-}	Inverting Input Resistance	$-15V \leq V_{CM} \leq +15V$	3.6	5		k Ω	
R_{I+}	Non-Inverting Input Resistance	$-15V \leq V_{CM} \leq +15V$	1.8	2.5		k Ω	
R_T	Line Termination Resistance	$T_A = 25^\circ C$	120	170	250	Ω	
I_{I-}	Inverting Input Current	$V_{CM} = 15V$		3.0	4.2	mA	
		$V_{CM} = 0V$		0	-0.5	mA	
		$V_{CM} = -15V$		-3.0	-4.2	mA	
I_{I+}	Non-Inverting Input Current	$V_{CM} = 15V$		5.0	7.0	mA	
		$V_{CM} = 0V$		-1.0	-1.6	mA	
		$V_{CM} = -15V$		-7.0	-9.8	mA	
I_{CC}	Power Supply Current One Side Only	$I_{OUT} = \text{Logical "0"}$	$V_{DIFF} = -1V$, $V_{CM} = 15V$		3.9	6.0	mA
			$V_{CM} = -15V$		9.2	14.0	mA
		$V_{DIFF} = -0.5V$, $V_{CM} = 0V$		6.5	10.2	mA	
V_{OH}	Logical "1" Output Voltage	$I_{OUT} = -400 \mu A$, $V_{DIFF} = 1V$	2.5	4.0	5.5	V	
V_{OL}	Logical "0" Output Voltage	$I_{OUT} = +16 mA$, $V_{DIFF} = -1V$	0	0.22	0.4	V	
V_{SH}	Logical "1" Strobe Input Voltage	$I_{OUT} = +16 mA$, $V_{OUT} \leq 0.4V$, $V_{DIFF} = -3V$	2.1			V	
V_{SL}	Logical "0" Strobe Input Voltage	$I_{OUT} = -400 \mu A$, $V_{OUT} \geq 2.5V$, $V_{DIFF} = -3V$			0.9	V	
I_{SH}	Logical "1" Strobe Input Current	$V_{STROBE} = 5.5V$, $V_{DIFF} = 3V$		0.01	5.0	μA	
I_{SL}	Logical "0" Strobe Input Current	$V_{STROBE} = 0.4V$, $V_{DIFF} = -3V$		-1.0	-1.4	mA	
I_{SC}	Output Short Circuit Current	$V_O = 0V$, $V_{CC} = 5.5V$, $V_{STROBE} = 0V$	-2.8	-4.5	-6.7	mA	

Note 3: "Absolute Maximum Ratings" are those values beyond which the safety of the device cannot be guaranteed. Except for "Operating Temperature Range" they are not meant to imply that the devices should be operated at these limits. The table of "Electrical Characteristics" provides conditions for actual device operation.

Note 4: These specifications apply for $4.5V \leq V_{CC} \leq 5.5V$, $-15V \leq V_{CM} \leq 15V$ and $-55^\circ C \leq T_A \leq +125^\circ C$ for the DS7820A or $4.75V \leq V_{CC} \leq 5.25V$, $0^\circ C \leq T_A \leq +70^\circ C$ for the DS8820A unless otherwise specified. Typical values given are for $V_{CC} = 5.0V$, $T_A = 25^\circ C$ and $V_{CM} = 0V$ unless stated differently.

Note 5: All currents into device pins shown as positive, out of device pins as negative, all voltages referenced to ground unless otherwise noted. All values shown as max or min on absolute value basis.

Note 6: Only one output at a time should be shorted.

Switching Characteristics

$T_A = 25^\circ\text{C}$, $V_{CC} = 5\text{V}$, unless otherwise noted

Symbol	Parameter	Conditions	Min	Typ	Max	Units
t_{pd0}	Propagation Delay, Differential Input to "0" Output	$R_L = 400\ \Omega$, $C_L = 15\ \text{pF}$, see <i>Figure 1</i>		30	45	ns
t_{pd1}	Propagation Delay, Differential Input to "1" Output			27	40	ns
t_{pd0}	Propagation Delay, Strobe Input to "0" Output			16	25	ns
t_{pd1}	Propagation Delay, Strobe Input to "1" Output			18	30	ns

AC Test Circuit and Waveforms

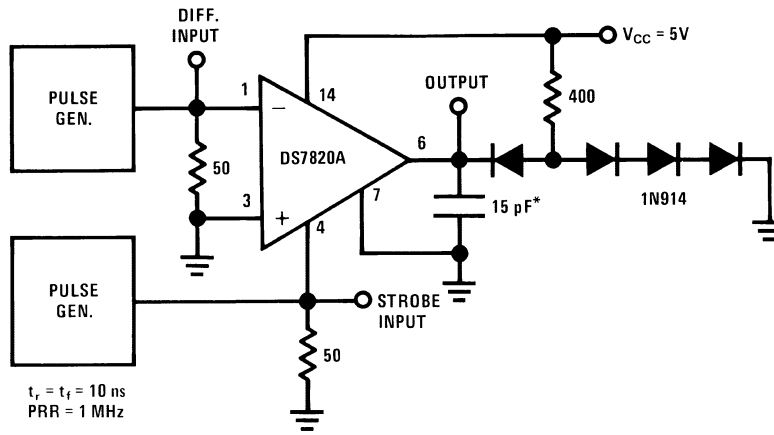

DS005797-7

Note 7: *Includes Jig and Probe Capacitance

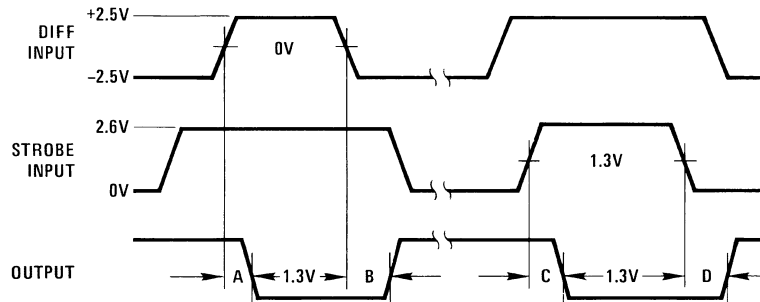

DS005797-8

- A = Differential Input to "0" Output
- B = Differential Input to "1" Output
- C = Strobe Input to "0" Output
- D = Strobe Input to "1" Output

FIGURE 1.

Typical Performance Characteristics

Supply Voltage Sensitivity

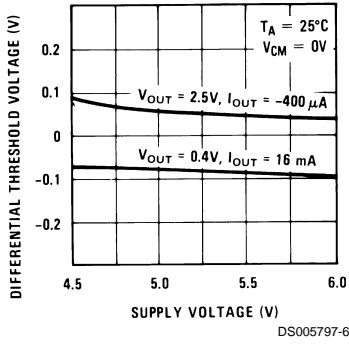

Common-Mode Voltage Sensitivity

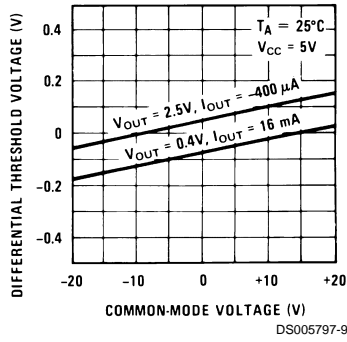

Temperature Sensitivity

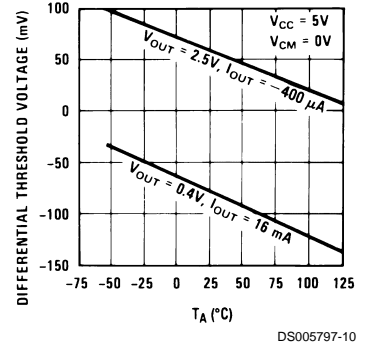

Transfer Function

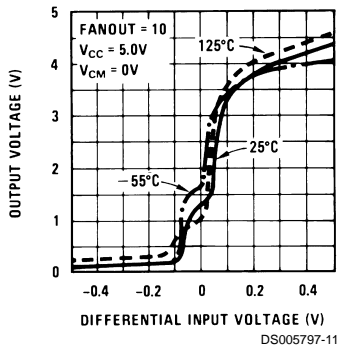

Termination Resistance

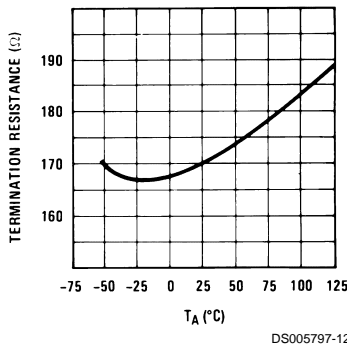

Input Characteristics

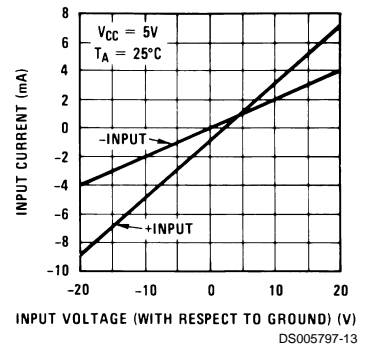

Power Supply Current

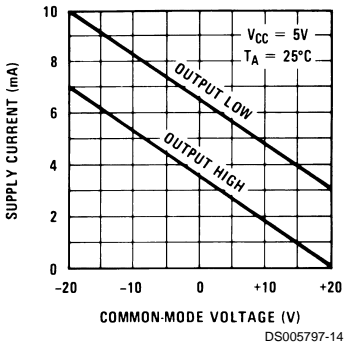

Internal Power Dissipation

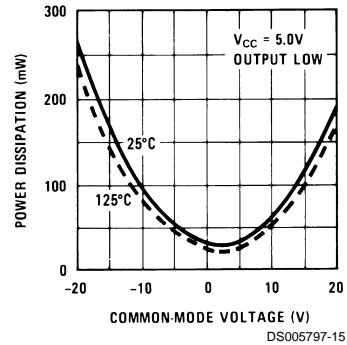

Output Voltage Levels

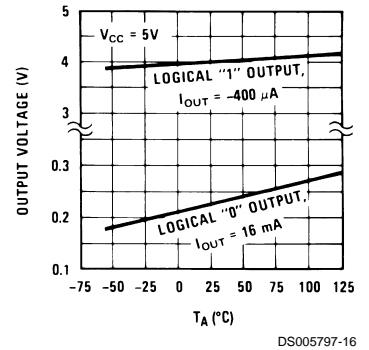

Differential Input Delays

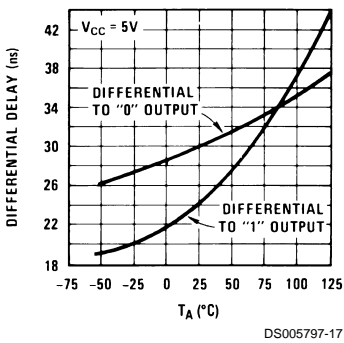

Strobe Delays

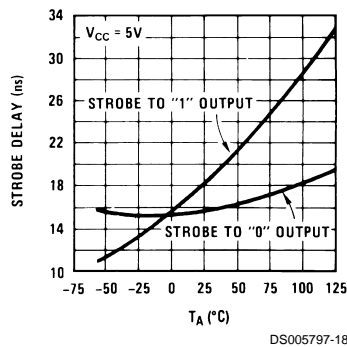

Noise Rejection

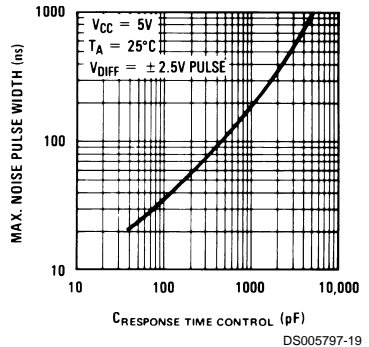

Schematic Diagram

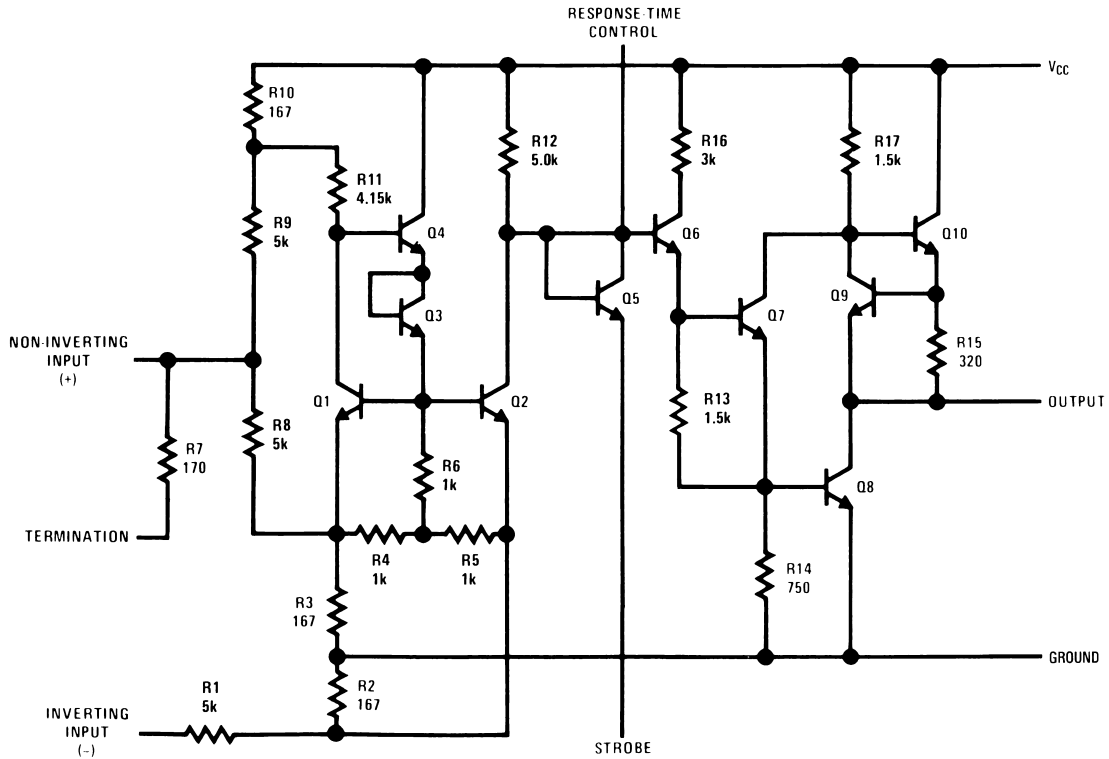

DS005797-1

Note 8: Schematic shows one-half of unit.

Typical Applications

Differential Line Driver and Receiver

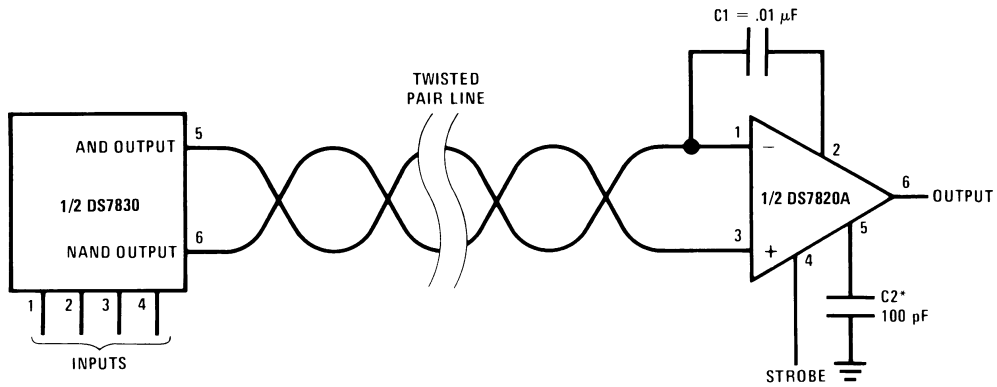

DS005797-3

Note 9: Optional to control response time.

Single Ended (EIA-RS232C) Receiver with Hysteresis

Typical Applications (Continued)

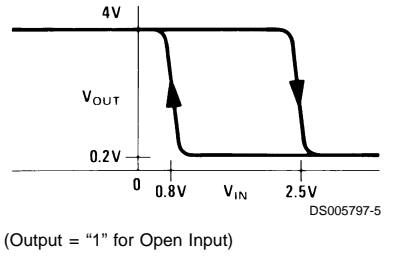
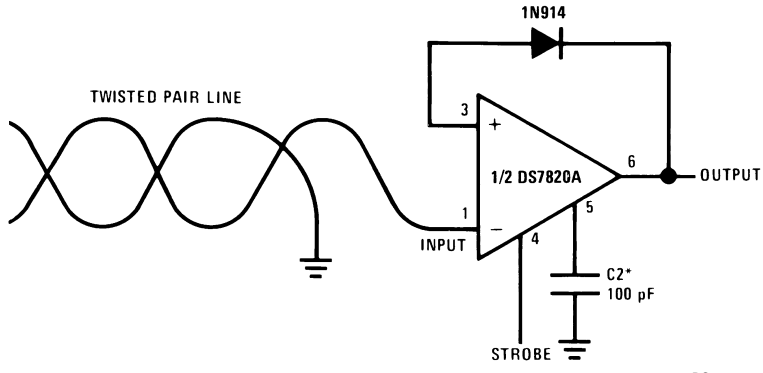

Physical Dimensions inches (millimeters) unless otherwise noted

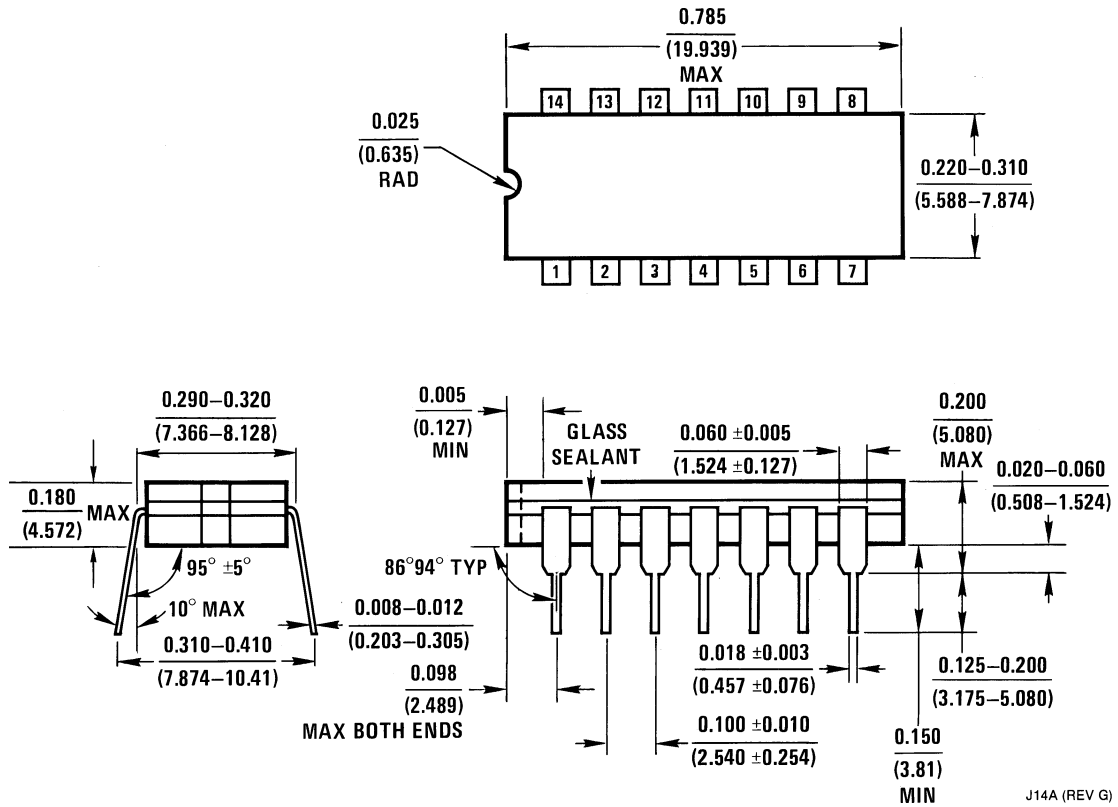

Ceramic Dual-In-Line Package (J)
Order Number DS7820AJ or DS7820AJ/883
NS Package Number J14A

Physical Dimensions inches (millimeters) unless otherwise noted (Continued)

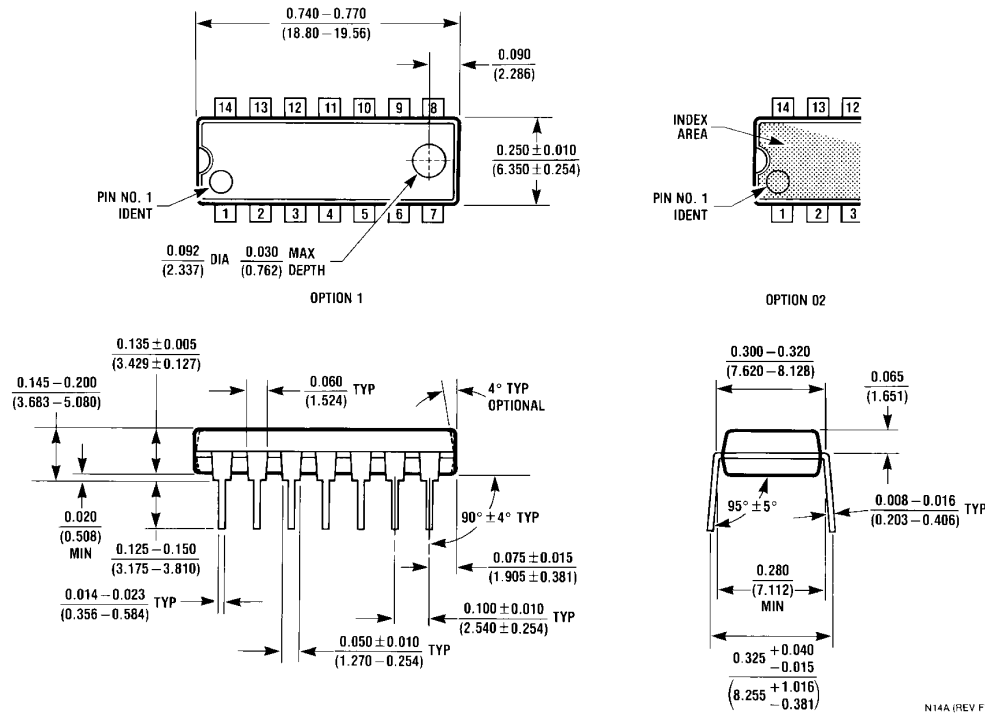

N14A (REV F)

LIFE SUPPORT POLICY

NATIONAL'S PRODUCTS ARE NOT AUTHORIZED FOR USE AS CRITICAL COMPONENTS IN LIFE SUPPORT DEVICES OR SYSTEMS WITHOUT THE EXPRESS WRITTEN APPROVAL OF THE PRESIDENT AND GENERAL COUNSEL OF NATIONAL SEMICONDUCTOR CORPORATION. As used herein:

1. Life support devices or systems are devices or systems which, (a) are intended for surgical implant into the body, or (b) support or sustain life, and whose failure to perform when properly used in accordance with instructions for use provided in the labeling, can be reasonably expected to result in a significant injury to the user.
2. A critical component is any component of a life support device or system whose failure to perform can be reasonably expected to cause the failure of the life support device or system, or to affect its safety or effectiveness.



National Semiconductor Corporation
 Americas
 Email: support@nsc.com

National Semiconductor Europe
 Fax: +49 (0) 180-530 85 86
 Email: europe.support@nsc.com
 Deutsch Tel: +49 (0) 69 9508 6208
 English Tel: +44 (0) 870 24 0 2171
 Français Tel: +33 (0) 1 41 91 8790

National Semiconductor Asia Pacific Customer Response Group
 Tel: 65-2544466
 Fax: 65-2504466
 Email: ap.support@nsc.com

National Semiconductor Japan Ltd.
 Tel: 81-3-5639-7560
 Fax: 81-3-5639-7507

www.national.com

IMPORTANT NOTICE

Texas Instruments Incorporated and its subsidiaries (TI) reserve the right to make corrections, modifications, enhancements, improvements, and other changes to its products and services at any time and to discontinue any product or service without notice. Customers should obtain the latest relevant information before placing orders and should verify that such information is current and complete. All products are sold subject to TI's terms and conditions of sale supplied at the time of order acknowledgment.

TI warrants performance of its hardware products to the specifications applicable at the time of sale in accordance with TI's standard warranty. Testing and other quality control techniques are used to the extent TI deems necessary to support this warranty. Except where mandated by government requirements, testing of all parameters of each product is not necessarily performed.

TI assumes no liability for applications assistance or customer product design. Customers are responsible for their products and applications using TI components. To minimize the risks associated with customer products and applications, customers should provide adequate design and operating safeguards.

TI does not warrant or represent that any license, either express or implied, is granted under any TI patent right, copyright, mask work right, or other TI intellectual property right relating to any combination, machine, or process in which TI products or services are used. Information published by TI regarding third-party products or services does not constitute a license from TI to use such products or services or a warranty or endorsement thereof. Use of such information may require a license from a third party under the patents or other intellectual property of the third party, or a license from TI under the patents or other intellectual property of TI.

Reproduction of TI information in TI data books or data sheets is permissible only if reproduction is without alteration and is accompanied by all associated warranties, conditions, limitations, and notices. Reproduction of this information with alteration is an unfair and deceptive business practice. TI is not responsible or liable for such altered documentation. Information of third parties may be subject to additional restrictions.

Resale of TI products or services with statements different from or beyond the parameters stated by TI for that product or service voids all express and any implied warranties for the associated TI product or service and is an unfair and deceptive business practice. TI is not responsible or liable for any such statements.

TI products are not authorized for use in safety-critical applications (such as life support) where a failure of the TI product would reasonably be expected to cause severe personal injury or death, unless officers of the parties have executed an agreement specifically governing such use. Buyers represent that they have all necessary expertise in the safety and regulatory ramifications of their applications, and acknowledge and agree that they are solely responsible for all legal, regulatory and safety-related requirements concerning their products and any use of TI products in such safety-critical applications, notwithstanding any applications-related information or support that may be provided by TI. Further, Buyers must fully indemnify TI and its representatives against any damages arising out of the use of TI products in such safety-critical applications.

TI products are neither designed nor intended for use in military/aerospace applications or environments unless the TI products are specifically designated by TI as military-grade or "enhanced plastic." Only products designated by TI as military-grade meet military specifications. Buyers acknowledge and agree that any such use of TI products which TI has not designated as military-grade is solely at the Buyer's risk, and that they are solely responsible for compliance with all legal and regulatory requirements in connection with such use.

TI products are neither designed nor intended for use in automotive applications or environments unless the specific TI products are designated by TI as compliant with ISO/TS 16949 requirements. Buyers acknowledge and agree that, if they use any non-designated products in automotive applications, TI will not be responsible for any failure to meet such requirements.

Following are URLs where you can obtain information on other Texas Instruments products and application solutions:

Products

Audio	www.ti.com/audio
Amplifiers	amplifier.ti.com
Data Converters	dataconverter.ti.com
DLP® Products	www.dlp.com
DSP	dsp.ti.com
Clocks and Timers	www.ti.com/clocks
Interface	interface.ti.com
Logic	logic.ti.com
Power Mgmt	power.ti.com
Microcontrollers	microcontroller.ti.com
RFID	www.ti-rfid.com
OMAP Mobile Processors	www.ti.com/omap
Wireless Connectivity	www.ti.com/wirelessconnectivity

Applications

Communications and Telecom	www.ti.com/communications
Computers and Peripherals	www.ti.com/computers
Consumer Electronics	www.ti.com/consumer-apps
Energy and Lighting	www.ti.com/energy
Industrial	www.ti.com/industrial
Medical	www.ti.com/medical
Security	www.ti.com/security
Space, Avionics and Defense	www.ti.com/space-avionics-defense
Transportation and Automotive	www.ti.com/automotive
Video and Imaging	www.ti.com/video

TI E2E Community Home Page

e2e.ti.com

Mailing Address: Texas Instruments, Post Office Box 655303, Dallas, Texas 75265
Copyright © 2011, Texas Instruments Incorporated