

FEATURES

AC PERFORMANCE

Unity-Gain Bandwidth: 40 MHz
Fast Settling: 110 ns to 0.01%
Slew Rate: 300 V/ μ s
Full Power Bandwidth: 4.7 MHz for 20 V p-p into a 500 Ω Load

DC PERFORMANCE

Input Offset Voltage: 1 mV max
Input Voltage Noise: 13 nV/ $\sqrt{\text{Hz}}$ typ
Open-Loop Gain: 45 V/mV into a 1 k Ω Load
Output Current: 50 mA min
Supply Current: 12 mA max

APPLICATIONS

High Speed Signal Conditioning
Video and Pulse Amplifiers
Data Acquisition Systems
Line Drivers
Active Filters
Available in 14-Pin Plastic DIP Hermetic Cerdip, 12-Pin TO-8 Metal Can and 20-Pin LCC Packages
Chips and MIL-STD-883B Parts Available

PRODUCT DESCRIPTION

The AD841 is a member of the Analog Devices family of wide bandwidth operational amplifiers. This high speed/high precision family includes, among others, the AD840, which is stable at a gain of 10 or greater, and the AD842, which is stable at a gain of two or greater and has 100 mA minimum output current drive. These devices are fabricated using Analog Devices' junction isolated complementary bipolar (CB) process. This process permits a combination of dc precision and wideband ac performance previously unobtainable in a monolithic op amp. In addition to its 40 MHz unity-gain bandwidth product, the AD841 offers extremely fast settling characteristics, typically settling to within 0.01% of final value in 110 ns for a 10 volt step.

Unlike many high frequency amplifiers, the AD841 requires no external compensation. It remains stable over its full operating temperature range. It also offers a low quiescent current of 12 mA maximum, a minimum output current drive capability of 50 mA, a low input voltage noise of 13 nV/ $\sqrt{\text{Hz}}$ and low input offset voltage of 1 mV maximum.

The 300 V/ μ s slew rate of the AD841, along with its 40 MHz gain bandwidth, ensures excellent performance in video and pulse amplifier applications. This amplifier is well suited for use in high frequency signal conditioning circuits and wide bandwidth active filters. The extremely rapid settling time of the

REV. B

Information furnished by Analog Devices is believed to be accurate and reliable. However, no responsibility is assumed by Analog Devices for its use, nor for any infringements of patents or other rights of third parties which may result from its use. No license is granted by implication or otherwise under any patent or patent rights of Analog Devices.

CONNECTION DIAGRAMS

Plastic DIP (N) Package
and
Cerdip (Q) Package

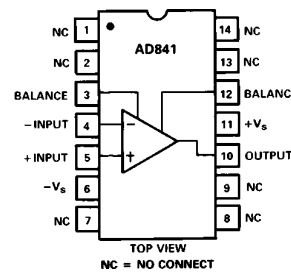

TO-8 (H) Package

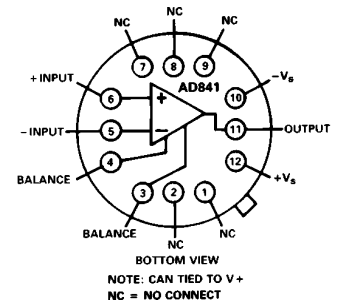

LCC (E) Package

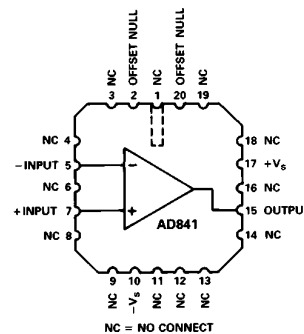

AD841 makes it the preferred choice for data acquisition applications which require 12-bit accuracy. The AD841 is also appropriate for other applications such as high speed DAC and ADC buffer amplifiers and other wide bandwidth circuitry.

APPLICATION HIGHLIGHTS

1. The high slew rate and fast settling time of the AD841 make it ideal for DAC and ADC buffers, and all types of video instrumentation circuitry.
2. The AD841 is a precision amplifier. It offers accuracy to 0.01% or better and wide bandwidth performance previously available only in hybrids.
3. The AD841's thermally balanced layout and the speed of the CB process allow the AD841 to settle to 0.01% in 110 ns without the long "tails" that occur with other fast op amps.
4. Laser wafer trimming reduces the input offset voltage to 1 mV max on the K grade, thus eliminating the need for external offset nulling in many applications. Offset null pins are provided for additional versatility.
5. The AD841 is an enhanced replacement for the HA2541.

AD841—SPECIFICATIONS (@ +25°C and ±15 V dc, unless otherwise noted)

Model	Conditions	AD841J			AD841K			AD841S ¹			Units
		Min	Typ	Max	Min	Typ	Max	Min	Typ	Max	
INPUT OFFSET VOLTAGE ²	$T_{MIN}-T_{MAX}$	0.8	2.0		0.5	1.0		0.5	2.0		mV
				5.0		3.3			5.5		mV
Offset Drift		35			35			35			$\mu\text{V}/^\circ\text{C}$
INPUT BIAS CURRENT	$T_{MIN}-T_{MAX}$	3.5	8		3.5	5		3.5	8		μA
				10		6			12		μA
		0.1	0.4		0.1	0.2		0.1	0.4		μA
Input Offset Current	$T_{MIN}-T_{MAX}$			0.5			0.3				μA
INPUT CHARACTERISTICS	Differential Mode										
Input Resistance		200			200			200			k Ω
Input Capacitance		2			2			2			pF
INPUT VOLTAGE RANGE											
Common Mode		± 10	12		± 10	12		± 10	12		V
Common-Mode Rejection	$V_{CM} = \pm 10\text{ V}$	86	100		103	109		86	110		dB
	$T_{MIN}-T_{MAX}$	80			100			80			dB
INPUT VOLTAGE NOISE	$f = 1\text{ kHz}$	15			15			15			$\text{nV}/\sqrt{\text{Hz}}$
Wideband Noise	10 Hz to 10 MHz	47			47			47			$\mu\text{V rms}$
OPEN-LOOP GAIN	$V_O = \pm 10\text{ V}$ $R_{LOAD} \geq 500\ \Omega$ $T_{MIN}-T_{MAX}$	25	45		25	45		25	45		V/mV
		12			20			12			V/mV
OUTPUT CHARACTERISTICS											
Voltage	$R_{LOAD} \geq 500\ \Omega$ $T_{MIN}-T_{MAX}$	± 10			± 10			± 10			V
Current	$V_{OUT} = \pm 10\text{ V}$	50			50			50			mA
OUTPUT RESISTANCE	Open Loop	5			5			5			Ω
FREQUENCY RESPONSE											
Unity Gain Bandwidth	$V_{OUT} = 90\text{ mV p-p}$	40			40			40			MHz
Full Power Bandwidth ³	$V_O = 20\text{ V p-p}$ $R_{LOAD} \geq 500\ \Omega$	3.1	4.7		3.1	4.7		3.1	4.7		MHz
Rise Time ⁴	$A_V = -1$		10			10			10		ns
Overshoot ⁴	$A_V = -1$		10			10			10		%
Slew Rate ⁴	$A_V = -1$	200	300		200	300		200	300		V/ μs
Settling Time – 10 V Step	$A_V = -1$ to 0.1%		90			00			90		ns
	to 0.01%		110			110			110		ns
OVERDRIVE RECOVERY	–Overdrive	200			200			200			ns
	+Overdrive	700			700			700			ns
DIFFERENTIAL GAIN	$f = 4.4\text{ MHz}$	0.03			0.03			0.03			%
Differential Phase	$f = 4.4\text{ MHz}$	0.022			0.022			0.022			Degree
POWER SUPPLY											
Rated Performance		± 5	± 15		± 5	± 15		± 5	± 15		V
Operating Range		± 5		± 18	± 5		± 18	± 5		± 18	V
Quiescent Current		11	12		11	12		11	12		mA
	$T_{MIN}-T_{MAX}$			14			14			16	mA
Power Supply Rejection Ratio	$V_S = \pm 5\text{ V to } \pm 18\text{ V}$	86	100		90	100		86	100		dB
	$T_{MIN}-T_{MAX}$	80			86			80			dB
TEMPERATURE RANGE											
Rated Performance ⁵		0		+75	0		+75	–55		+125	$^\circ\text{C}$
PACKAGE OPTIONS											
LCC (E-20A)											
Cerdip (Q-14)		AD841JQ			AD841KQ			AD841SE, AD841SE/883B			
Plastic (N-14)		AD841JN			AD841KN			AD841SQ, AD841SQ/883B			
TO-8 (H-12)		AD841JH			AD841KH			AD841SH, AD841SH/883B			
Chips		AD841J CHIPS						AD841S CHIPS			

NOTES

¹Standard Military Drawing Available: 5962-89641012A – (SE/883B); 5962-8964101CA – (SQ/883B).

²Input offset voltage specifications are guaranteed after 5 minutes at $T_A = +25^\circ\text{C}$.

³Full power bandwidth = Slew Rate/2 π V_{PEAK} .

⁴Refer to Figure 19.

⁵“S” grade $T_{MIN}-T_{MAX}$ specifications are tested with automatic test equipment at $T_A = -55^\circ\text{C}$ and $T_A = +125^\circ\text{C}$.

All min and max specifications are guaranteed. Specifications shown in **boldface** are tested on all production units.

Specifications subject to change without notice.

ABSOLUTE MAXIMUM RATINGS¹

Supply Voltage	±18 V
Internal Power Dissipation ²	
TO-8 (H)	1.4 W
Plastic (N)	1.5 W
Cerdip (Q)	1.3 W
Input Voltage	±V _S
Differential Input Voltage	±6 V
Storage Temperature Range	
Q, H, E	-65°C to +150°C
N	-65°C to +125°C
Junction Temperature	+175°C
Lead Temperature Range (Soldering 60 sec)	+300°C

NOTES

¹Stresses above those listed under "Absolute Maximum Ratings" may cause permanent damage to the device. This is a stress rating only, and functional operation of the device at these or any other conditions above those indicated in the operational section of this specification is not implied. Exposure to absolute maximum rating conditions for extended periods may affect device reliability.

²Maximum internal power dissipation is specified so that T_J does not exceed +175°C at an ambient temperature of +25°C.

Thermal Characteristics:

	θ _{JC}	θ _{JA}	θ _{SA}	
Cerdip Package	35°C/W	110°C/W	38°C/W	Recommended Heat Sink:
TO-8 Package	30°C/W	100°C/W	37°C/W	Aavid Engineering® #602B
Plastic Package	30°C/W	100°C/W		
LCC Package	35°C/W	150°C/W		

METALIZATION PHOTOGRAPH

Contact factory for latest dimensions.
Dimensions shown in inches and (mm).

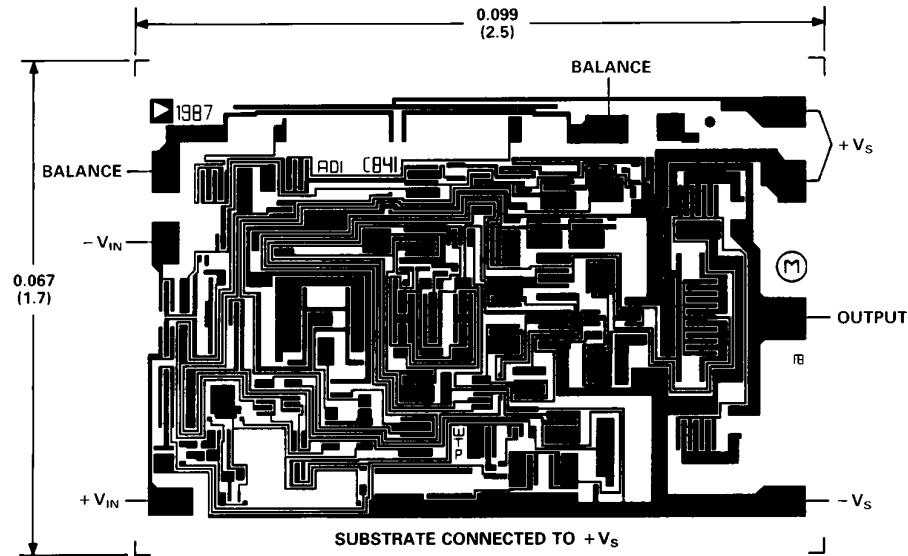

AD841—Typical Characteristics (at +25°C and $V_S = \pm 15$ V, unless otherwise noted)

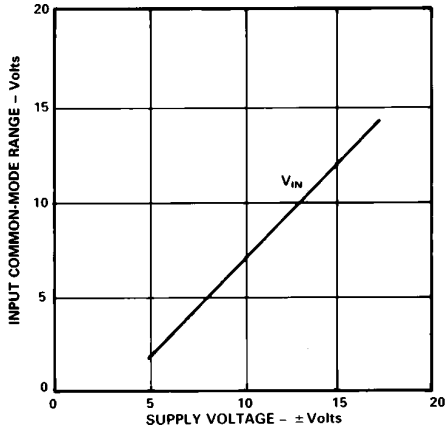

Figure 1. Input Common-Mode Range vs. Supply Voltage

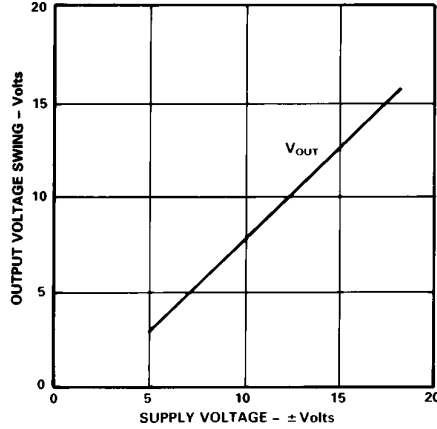

Figure 2. Output Voltage Swing vs. Supply Voltage

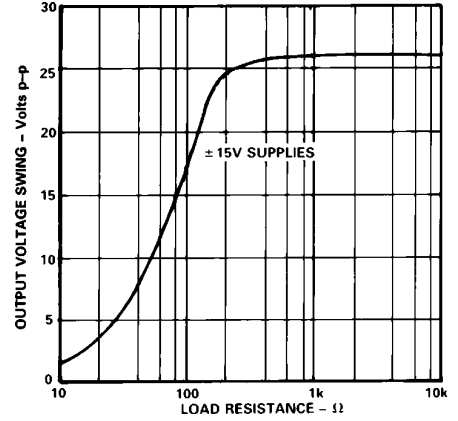

Figure 3. Output Voltage Swing vs. Load Resistance

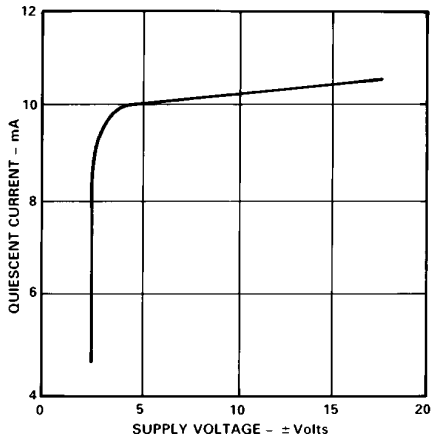

Figure 4. Quiescent Current vs. Supply Voltage

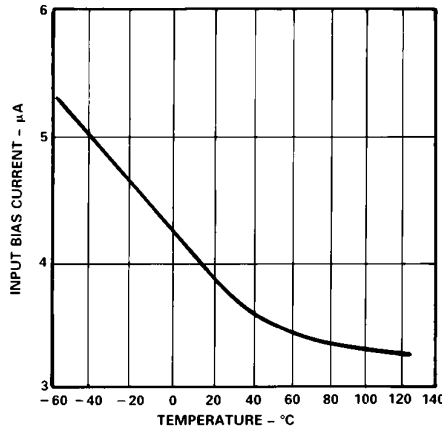

Figure 5. Input Bias Current vs. Temperature

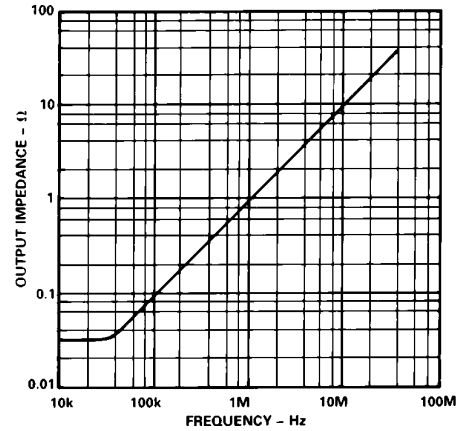

Figure 6. Output Impedance vs. Frequency

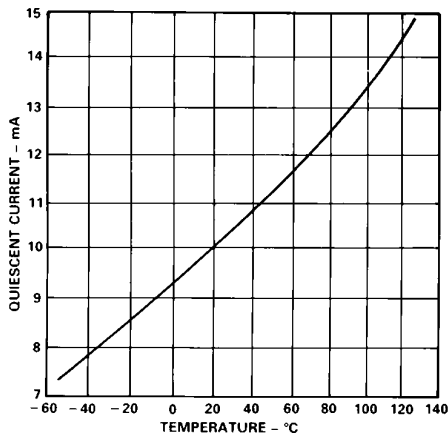

Figure 7. Quiescent Current vs. Temperature

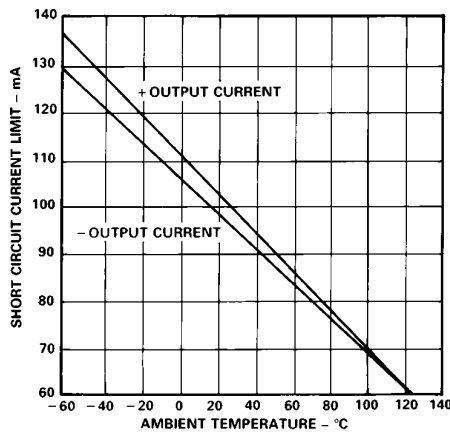

Figure 8. Short-Circuit Current Limit vs. Temperature

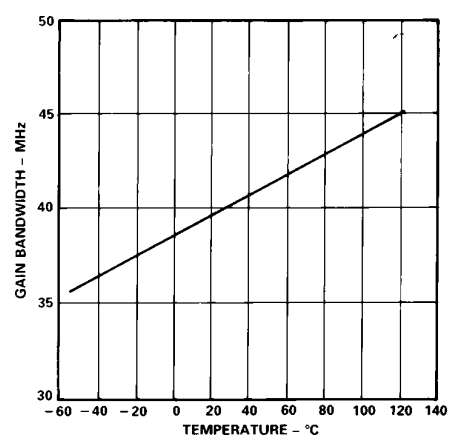

Figure 9. Gain Bandwidth Product vs. Temperature

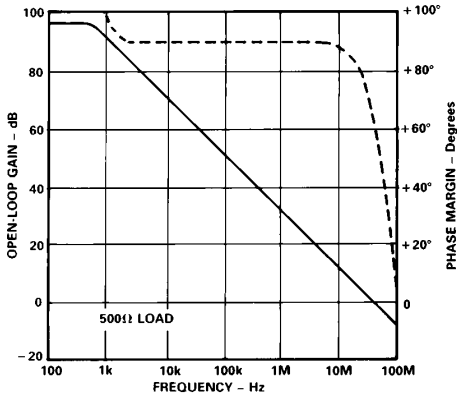

Figure 10. Open-Loop Gain and Phase Margin vs. Frequency

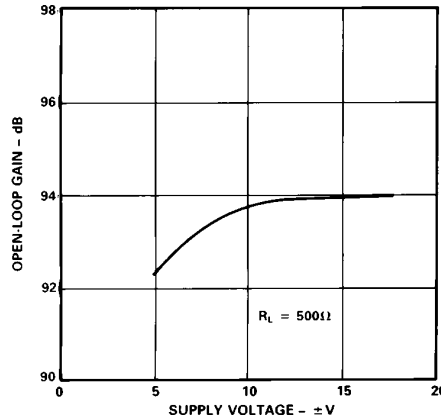

Figure 11. Open-Loop Gain vs. Supply Voltage

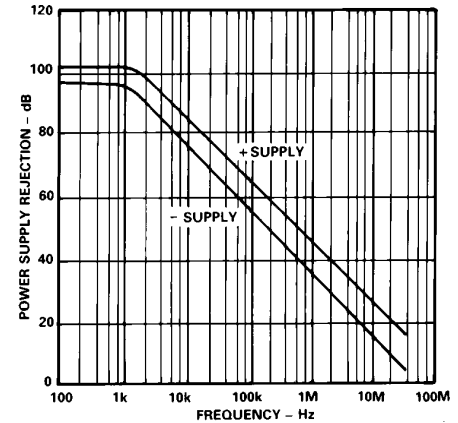

Figure 12. Power Supply Rejection vs. Frequency

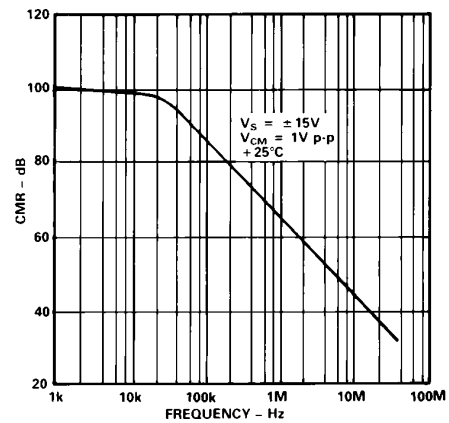

Figure 13. Common-Mode Rejection vs. Frequency

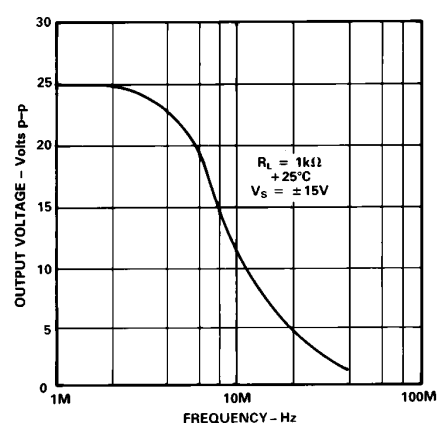

Figure 14. Large Signal Frequency Response

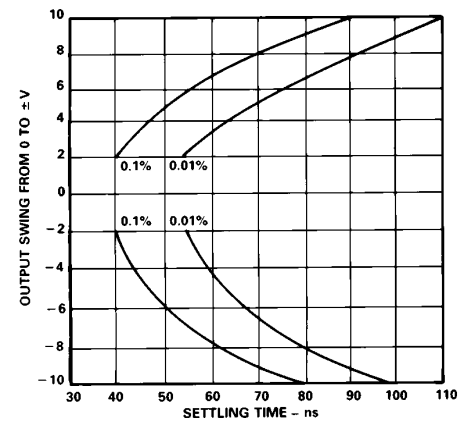

Figure 15. Output Swing and Error vs. Settling Time

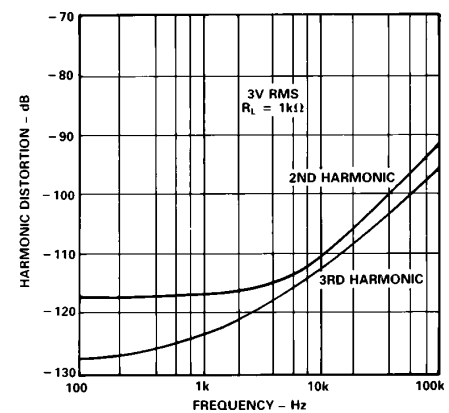

Figure 16. Harmonic Distortion vs. Frequency

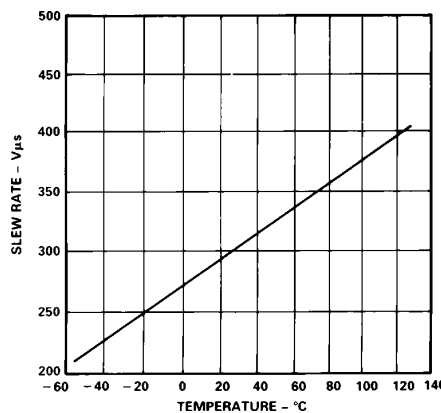

Figure 17. Slew Rate vs. Temperature

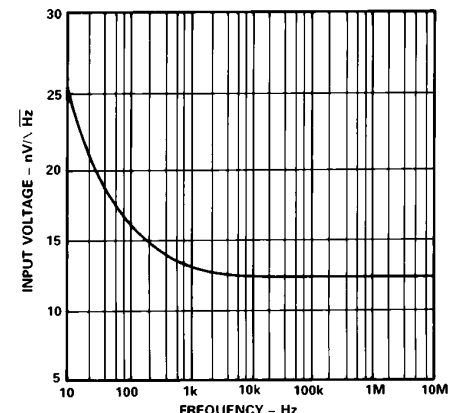

Figure 18. Input Voltage Noise Spectral Density

AD841

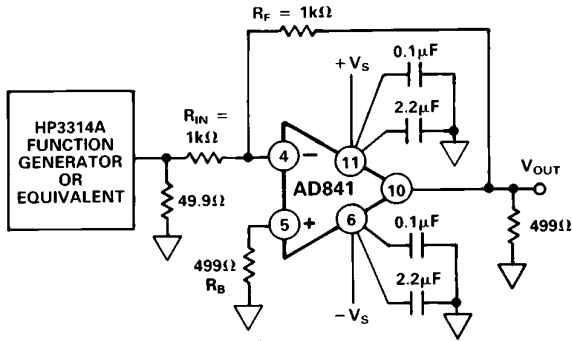

Figure 19a. Inverting Amplifier Configuration (DIP Pinout)

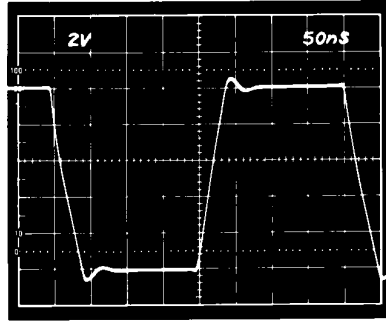

Figure 19b. Inverter Large Signal Pulse Response

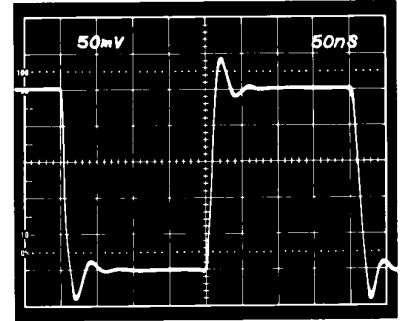

Figure 19c. Inverter Small Signal Pulse Response

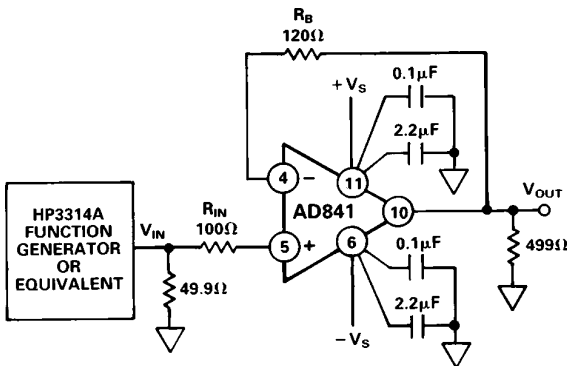

Figure 20a. Unity-Gain Buffer Amplifier Configuration (DIP Pinout)

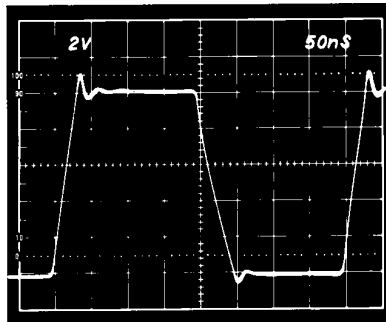

Figure 20b. Buffer Large Signal Pulse Response

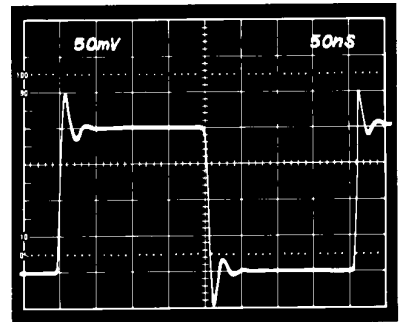

Figure 20c. Buffer Small Signal Pulse Response

OFFSET NULLING

The input offset voltage of the AD841 is very low for a high speed op amp, but if additional nulling is required, the circuit shown in Figure 21 can be used.

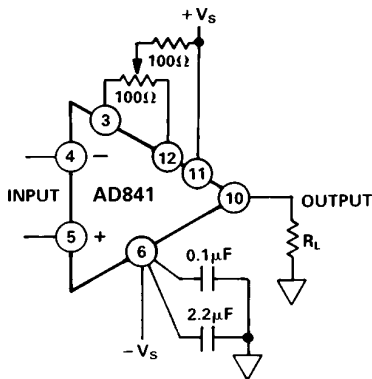

Figure 21. Offset Nulling (DIP Pinout)

INPUT CONSIDERATIONS

An input resistor (R_{IN} in Figure 20) is recommended in circuits where the input to the AD841 will be subjected to transient or continuous overload voltages exceeding the ± 6 V maximum differential limit. This resistor provides protection for the input transistors by limiting the maximum current that can be forced into the input.

For high performance circuits it is recommended that a resistor (R_B in Figures 19 and 20) be used to reduce bias current errors by matching the impedance at each input. The output voltage error caused by the offset current is more than an order of magnitude less than the error present if the bias current error is not removed.

AD841 SETTling TIME

Figures 22 and 24 show the settling performance of the AD841 in the test circuit shown in Figure 23.

Settling time is defined as:

The interval of time from the application of an ideal step function input until the closed-loop amplifier output has entered and remains within a specified error band.

This definition encompasses the major components which comprise settling time. They include (1) propagation delay through the amplifier; (2) slewing time to approach the final output value; (3) the time of recovery from the overload associated with slewing and (4) linear settling to within the specified error band.

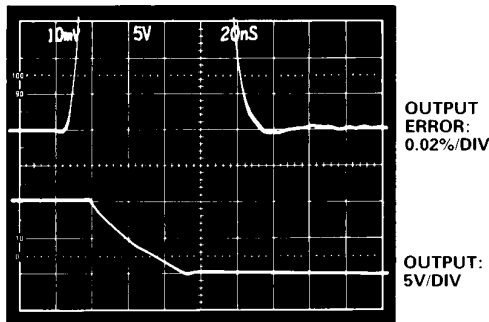

Figure 22. AD841 0.01% Settling Time

Expressed in these terms, the measurement of settling time is obviously a challenge and needs to be done accurately to assure the user that the amplifier is worth consideration for the application.

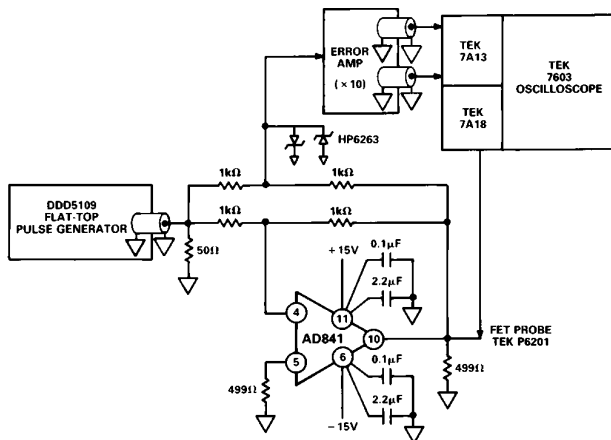

Figure 23. Settling Time Test Circuit

Measurement of the AD841's 0.01% settling in 110 ns was accomplished by amplifying the error signal from a false summing junction with a very high speed proprietary hybrid error amplifier specially designed to enable testing of small settling errors. The device under test was driving a 500 Ω load. The input to the error amp is clamped in order to avoid possible problems associated with the overdrive recovery of the oscilloscope input amplifier. The error amp gains the error from the false summing junction by 10, and it contains a gain vernier to fine trim the gain.

Figure 24 shows the "long term" stability of the settling characteristics of the AD841 output after a 10 V step. There is no evidence of settling tails after the initial transient recovery time. The use of a junction isolated process, together with careful layout, avoids these problems by minimizing the effects of transistor isolation capacitance discharge and thermally induced shifts in circuit operating points. These problems do not occur even under high output current conditions.

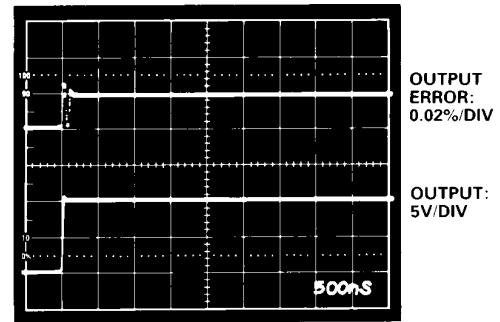

Figure 24. AD841 Settling Demonstrating No Settling Tails

GROUNDING AND BYPASSING

In designing practical circuits with the AD841, the user must remember that whenever high frequencies are involved, some special precautions are in order. Circuits must be built with short interconnect leads. Large ground planes should be used whenever possible to provide a low resistance, low inductance circuit path, as well as minimizing the effects of high frequency coupling. Sockets should be avoided because the increased interlead capacitance can degrade bandwidth.

Feedback resistors should be of low enough value to assure that the time constant formed with the circuit capacitances will not limit the amplifier performance. Resistor values of less than 5 kΩ are recommended. If a larger resistor must be used, a small (<10 pF) feedback capacitor in parallel with the feedback resistor, R_F , may be used to compensate for these stray capacitances and optimize the dynamic performance of the amplifier in the particular application.

Power supply leads should be bypassed to ground as close as possible to the amplifier pins. A 2.2 μF capacitor in parallel with a 0.1 μF ceramic disk capacitor is recommended.

CAPACITIVE LOAD DRIVING ABILITY

Like all wideband amplifiers, the AD841 is sensitive to capacitive loading. The AD841 is designed to drive capacitive loads of up to 20 pF without degradation of its rated performance. Capacitive loads of greater than 20 pF will decrease the dynamic performance of the part although instability should not occur unless the load exceeds 100 pF (for a unity-gain follower). A resistor in series with the output can be used to decouple larger capacitive loads.

Figure 25 shows a typical configuration for driving a large capacitive load. The 51 Ω output resistor effectively isolates the high frequency feedback from the load and stabilizes the circuit. Low frequency feedback is returned to the amplifier summing junction via the low pass filter formed by the 51 Ω resistor and the load capacitance, C_L .

AD841

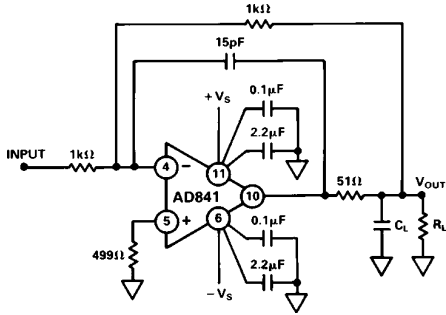

Figure 25. Circuit for Driving a Large Capacitive Load

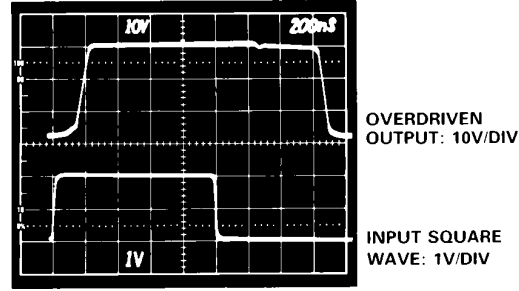

Figure 27. Overdrive Recovery

USING A HEAT SINK

The AD841 draws less quiescent power than most precision high speed amplifiers and is specified for operation without a heat sink. However, when driving low impedance loads, the current to the load can be 4 to 5 times the quiescent current. This will create a noticeable temperature rise. Improved performance can be achieved by using a small heat sink such as the Aavid Engineering #602B.

TERMINATED LINE DRIVER

The AD841 functions very well as a high speed line driver of either terminated or unterminated cables. Figure 26 shows the AD841 driving a doubly terminated cable in a follower configuration. The AD841 maintains a typical slew rate of 300 V/μs, which means it can drive a ±10 V, 4.7 MHz signal or a ±3 V, 15.9 MHz signal.

The termination resistor, R_T , (when equal to the characteristic impedance of the cable) minimizes reflections from the far end of the cable. A back-termination resistor (R_{BT} , also equal to the characteristic impedance of the cable) may be placed between the AD841 output and the cable in order to damp any stray signals caused by a mismatch between R_T and the cable's characteristic impedance. This will result in a "cleaner" signal, but since 1/2 the output voltage will be dropped across R_{BT} , the op amp must supply double the output signal required if there is no back termination. Therefore the full power bandwidth is cut in half.

If termination is not used, cables appear as capacitive loads. If this capacitive load is large, it should be decoupled from the AD841 by a resistor in series with the output (see above: Driving a Capacitive Load).

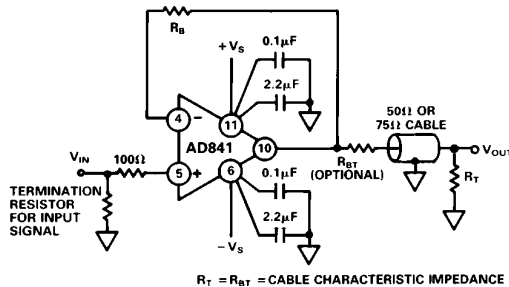

Figure 26. Line Driver Configuration

OVERDRIVE RECOVERY

Figure 27 shows the overdrive recovery capability of the AD841. Typical recovery time is 200 ns from negative overdrive and 700 ns from positive overdrive.

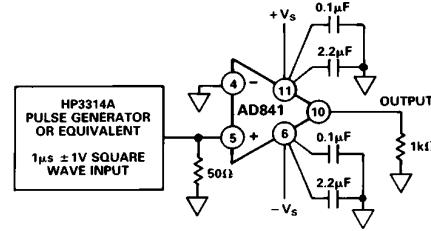
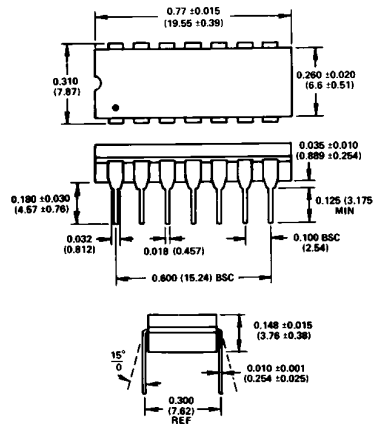

Figure 28. Overdrive Recovery Test Circuit

OUTLINE DIMENSIONS

Dimensions shown in inches and (mm).

14-Pin Plastic (N) Package



14-Pin Cerdip (Q) Package

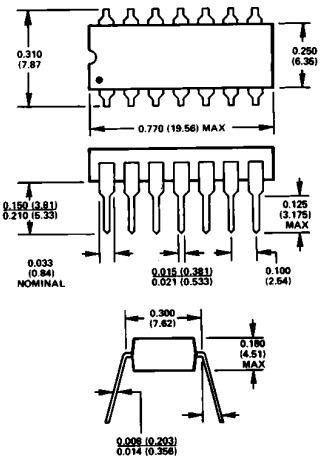

12-Lead Metal Can Package (TO-8 Style)

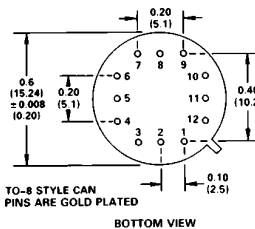

E-20A 20-Terminal Leadless Ceramic Chip Carrier

