

### FEATURES

#### Single Supply Operation

Output Swings Rail to Rail

Input Voltage Range Extends Below Ground

Single Supply Capability from +3 V to +36 V

#### High Load Drive

Capacitive Load Drive of 500 pF,  $G = +1$

Output Current of 15 mA, 0.5 V from Supplies

#### Excellent AC Performance on 2.6 mA/Amplifier

-3 dB Bandwidth of 16 MHz,  $G = +1$

350 ns Settling Time to 0.01% (2 V Step)

Slew Rate of 22 V/ $\mu$ s

#### Good DC Performance

800  $\mu$ V Max Input Offset Voltage

2  $\mu$ V/ $^{\circ}$ C Offset Voltage Drift

25 pA Max Input Bias Current

#### Low Distortion

-108 dBc Worst Harmonic @ 20 kHz

#### Low Noise

16 nV/ $\sqrt{\text{Hz}}$  @ 10 kHz

#### No Phase Inversion with Inputs to the Supply Rails

### APPLICATIONS

Battery Powered Precision Instrumentation

Photodiode Preamps

Active Filters

12- to 16-Bit Data Acquisition Systems

Medical Instrumentation

### PRODUCT DESCRIPTION

The AD823 is a dual precision, 16 MHz, JFET input op amp that can operate from a single supply of +3.0 V to +36 V, or dual supplies of  $\pm 1.5$  V to  $\pm 18$  V. It has true single supply capability with an input voltage range extending below ground in single supply mode. Output voltage swing extends to within 50 mV of each rail for  $I_{OUT} \leq 100 \mu\text{A}$  providing outstanding output dynamic range.

Offset voltage of 800  $\mu\text{V}$  max, offset voltage drift of 2  $\mu\text{V}/^{\circ}\text{C}$ , input bias currents below 25 pA and low input voltage noise provide dc precision with source impedances up to a Gohm. 16 MHz, -3 dB bandwidth, -108 dB THD @ 20 kHz and 22 V/ $\mu$ s slew rate are provided with a low supply current of 2.6 mA per amplifier. The AD823 drives up to 500 pF of direct capacitive load as a follower, and provides an output current of 15 mA, 0.5 V from the supply rails. This allows the amplifier to handle a wide range of load conditions.

This combination of ac and dc performance, plus the outstanding load drive capability results in an exceptionally versatile amplifier for applications such as A/D drivers, high-speed active filters, and other low voltage, high dynamic range systems.

### REV. 0

Information furnished by Analog Devices is believed to be accurate and reliable. However, no responsibility is assumed by Analog Devices for its use, nor for any infringements of patents or other rights of third parties which may result from its use. No license is granted by implication or otherwise under any patent or patent rights of Analog Devices.

### CONNECTION DIAGRAM

8-Pin Plastic Mini-DIP  
and  
8-Lead SOIC

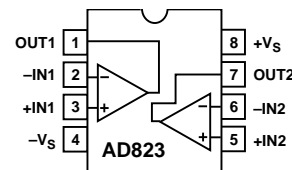

The AD823 is available over the industrial temperature range of  $-40^{\circ}\text{C}$  to  $+85^{\circ}\text{C}$  and is offered in both 8-pin plastic DIP and SOIC packages.

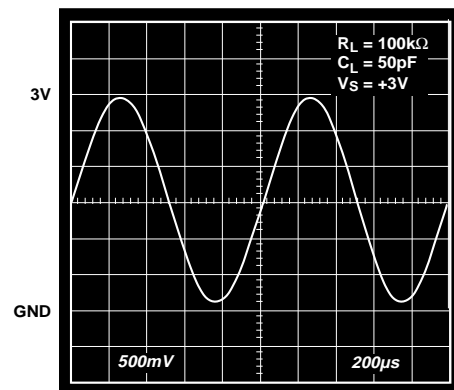

Figure 1. Output Swing,  $V_S = +3$  V,  $G = +1$

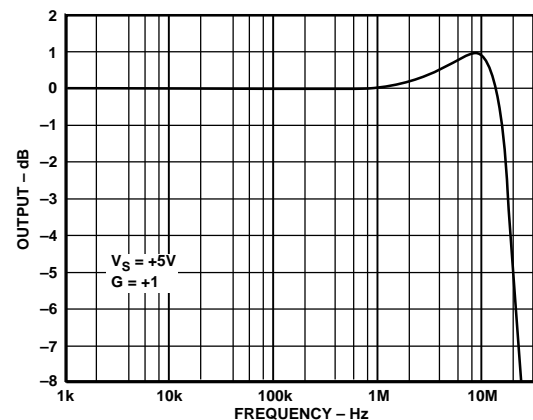

Figure 2. Small Signal Bandwidth,  $G = +1$

# AD823—SPECIFICATIONS (@ $T_A = +25^\circ\text{C}$ , $V_S = +5\text{ V}$ , $R_L = 2\text{ k}\Omega$ to $+2.5\text{ V}$ , unless otherwise noted)

Parameter	Conditions	AD823A			Units
		Min	Typ	Max	
<b>DYNAMIC PERFORMANCE</b>					
-3 dB Bandwidth, $V_O \leq 0.2\text{ V p-p}$	$G = +1$	12	16		MHz
Full Power Response	$V_O = 2\text{ V p-p}$		3.5		MHz
Slew Rate	$G = -1$ , $V_O = 4\text{ V Step}$	14	22		V/ $\mu\text{s}$
Settling Time to 0.1%	$G = -1$ , $V_O = 2\text{ V Step}$		320		ns
to 0.01%			350		ns
<b>NOISE/DISTORTION PERFORMANCE</b>					
Input Voltage Noise	$f = 10\text{ kHz}$		16		$\text{nV}/\sqrt{\text{Hz}}$
Input Current Noise	$f = 1\text{ kHz}$		1		$\text{fA}/\sqrt{\text{Hz}}$
Harmonic Distortion	$R_L = 600\ \Omega$ to $2.5\text{ V}$ , $V_O = 2\text{ V p-p}$ , $f = 20\text{ kHz}$		-108		dBc
Crosstalk					
$f = 1\text{ kHz}$	$R_L = 5\text{ k}\Omega$		-130		dB
$f = 1\text{ MHz}$	$R_L = 5\text{ k}\Omega$		-93		dB
<b>DC PERFORMANCE</b>					
Initial Offset			0.2	0.8	mV
Max Offset Over Temperature			0.3	2.0	mV
Offset Drift			2		$\mu\text{V}/^\circ\text{C}$
Input Bias Current	$V_{CM} = 0\text{ V to }+4\text{ V}$		3	25	pA
at $T_{MAX}$			0.5	5	nA
Input Offset Current			2	20	pA
at $T_{MAX}$			0.5		nA
Open-Loop Gain	$V_O = 0.2\text{ V to }4\text{ V}$ $R_L = 2\text{ k}\Omega$	20	45		V/mV
$T_{MIN}$ to $T_{MAX}$		20			V/mV
<b>INPUT CHARACTERISTICS</b>					
Input Common-Mode Voltage Range		-0.2 to 3	-0.2 to 3.8		V
Input Resistance			$10^{13}$		$\Omega$
Input Capacitance			1.8		pF
Common-Mode Rejection Ratio	$V_{CM} = 0\text{ V to }3\text{ V}$	60	76		dB
<b>OUTPUT CHARACTERISTICS</b>					
Output Voltage Swing					
$I_L = \pm 100\ \mu\text{A}$			0.025 to 4.975		V
$I_L = \pm 2\text{ mA}$			0.08 to 4.92		V
$I_L = \pm 10\text{ mA}$			0.25 to 4.75		V
Output Current	$V_{OUT} = 0.5\text{ V to }4.5\text{ V}$		16		mA
Short Circuit Current	Sourcing to $2.5\text{ V}$		40		mA
	Sinking to $2.5\text{ V}$		30		mA
Capacitive Load Drive	$G = +1$		500		pF
<b>POWER SUPPLY</b>					
Operating Range		+3		+36	V
Quiescent Current	$T_{MIN}$ to $T_{MAX}$ , Total		5.2	5.6	mA
Power Supply Rejection Ratio	$V_S = +5\text{ V to }+15\text{ V}$ , $T_{MIN}$ to $T_{MAX}$	70	80		dB

Specification subject to change without notice.

**SPECIFICATIONS** (@  $T_A = +25^\circ\text{C}$ ,  $V_S = +3.3\text{ V}$ ,  $R_L = 2\text{ k}\Omega$  to  $+1.65\text{ V}$ , unless otherwise noted)

Parameter	Conditions	AD823A			Units
		Min	Typ	Max	
<b>DYNAMIC PERFORMANCE</b>					
-3 dB Bandwidth, $V_O \leq 0.2\text{ V p-p}$	$G = +1$	12	15		MHz
Full Power Response	$V_O = 2\text{ V p-p}$		3.2		MHz
Slew Rate	$G = -1$ , $V_O = 2\text{ V Step}$	13	20		V/ $\mu\text{s}$
Settling Time to 0.1%	$G = -1$ , $V_O = 2\text{ V Step}$		250		ns
to 0.01%			300		ns
<b>NOISE/DISTORTION PERFORMANCE</b>					
Input Voltage Noise	$f = 10\text{ kHz}$		16		nV/ $\sqrt{\text{Hz}}$
Input Current Noise	$f = 1\text{ kHz}$		1		fA/ $\sqrt{\text{Hz}}$
Harmonic Distortion	$R_L = 100\ \Omega$ , $V_O = 2\text{ V p-p}$ , $f = 20\text{ kHz}$		-93		dBc
Crosstalk					
$f = 1\text{ kHz}$	$R_L = 5\text{ k}\Omega$		-130		dB
$f = 1\text{ MHz}$	$R_L = 5\text{ k}\Omega$		-93		dB
<b>DC PERFORMANCE</b>					
Initial Offset			0.2	1.5	mV
Max Offset Over Temperature			0.5	2.5	mV
Offset Drift			2		$\mu\text{V}/^\circ\text{C}$
Input Bias Current at $T_{\text{MAX}}$	$V_{\text{CM}} = 0\text{ V to }+2\text{ V}$		3	25	pA
Input Offset Current at $T_{\text{MAX}}$			0.5	5	nA
Open-Loop Gain			2	20	pA
	$V_O = 0.2\text{ V to }2\text{ V}$		0.5		nA
$T_{\text{MIN}}$ to $T_{\text{MAX}}$	$R_L = 2\text{ k}\Omega$	15	30		V/mV
		12			V/mV
<b>INPUT CHARACTERISTICS</b>					
Input Common-Mode Voltage Range		-0.2 to 1	-0.2 to 1.8		V
Input Resistance			$10^{13}$		$\Omega$
Input Capacitance			1.8		pF
Common-Mode Rejection Ratio	$V_{\text{CM}} = 0\text{ V to }1\text{ V}$	54	70		dB
<b>OUTPUT CHARACTERISTICS</b>					
Output Voltage Swing			0.025 to 3.275		V
$I_L = \pm 100\ \mu\text{A}$			0.08 to 3.22		V
$I_L = \pm 2\text{ mA}$			0.25 to 3.05		V
$I_L = \pm 10\text{ mA}$					V
Output Current	$V_{\text{OUT}} = 0.5\text{ V to }2.5\text{ V}$		15		mA
Short Circuit Current	Sourcing to 1.5 V		40		mA
	Sinking to 1.5 V		30		mA
Capacitive Load Drive	$G = +1$		500		pF
<b>POWER SUPPLY</b>					
Operating Range		+3		+36	V
Quiescent Current	$T_{\text{MIN}}$ to $T_{\text{MAX}}$ , Total		5.0	5.7	mA
Power Supply Rejection Ratio	$V_S = +3.3\text{ V to }+15\text{ V}$ , $T_{\text{MIN}}$ to $T_{\text{MAX}}$	70	80		dB

Specification subject to change without notice.

# AD823—SPECIFICATIONS

(@  $T_A = +25^\circ\text{C}$ ,  $V_S = \pm 15\text{ V}$ ,  $R_L = 2\text{ k}\Omega$  to  $0\text{ V}$ , unless otherwise noted)

Parameter	Conditions	Min	AD823A		Units
			Typ	Max	
<b>DYNAMIC PERFORMANCE</b>					
-3 dB Bandwidth, $V_O \leq 0.2\text{ V p-p}$	$G = +1$	12	16		MHz
Full Power Response	$V_O = 2\text{ V p-p}$		4		MHz
Slew Rate	$G = -1$ , $V_O = 10\text{ V Step}$	17	25		V/ $\mu\text{s}$
Settling Time to 0.1%	$G = -1$ , $V_O = 10\text{ V Step}$		550		ns
to 0.01%			650		ns
<b>NOISE/DISTORTION PERFORMANCE</b>					
Input Voltage Noise	$f = 10\text{ kHz}$		16		$\text{nV}/\sqrt{\text{Hz}}$
Input Current Noise	$f = 1\text{ kHz}$		1		$\text{fA}/\sqrt{\text{Hz}}$
Harmonic Distortion	$R_L = 600\ \Omega$ , $V_O = 10\text{ V p-p}$ , $f = 20\text{ kHz}$		-90		dBc
Crosstalk					
$f = 1\text{ kHz}$	$R_L = 5\text{ k}\Omega$		-130		dB
$f = 1\text{ MHz}$	$R_L = 5\text{ k}\Omega$		-93		dB
<b>DC PERFORMANCE</b>					
Initial Offset			0.7	3.5	mV
Max Offset Over Temperature			1.0	7	mV
Offset Drift			2		$\mu\text{V}/^\circ\text{C}$
Input Bias Current	$V_{\text{CM}} = 0\text{ V}$		5	30	pA
	$V_{\text{CM}} = -10\text{ V}$		60		pA
at $T_{\text{MAX}}$	$V_{\text{CM}} = 0\text{ V}$		0.5	5	nA
Input Offset Current			2	20	pA
at $T_{\text{MAX}}$			0.5		nA
Open-Loop Gain	$V_O = +10\text{ V to } -10\text{ V}$ $R_L = 2\text{ k}\Omega$	30	60		V/mV
$T_{\text{MIN}}$ to $T_{\text{MAX}}$		30			V/mV
<b>INPUT CHARACTERISTICS</b>					
Input Common-Mode Voltage Range		-15.2 to 13	-15.2 to 13.8		V
Input Resistance			$10^{13}$		$\Omega$
Input Capacitance			1.8		pF
Common-Mode Rejection Ratio	$V_{\text{CM}} = -15\text{ V to } +13\text{ V}$	66	82		dB
<b>OUTPUT CHARACTERISTICS</b>					
Output Voltage Swing					
$I_L = \pm 100\ \mu\text{A}$			-14.95 to +14.95		V
$I_L = \pm 2\text{ mA}$			-14.92 to +14.92		V
$I_L = \pm 10\text{ mA}$			-14.75 to +14.75		V
Output Current	$V_{\text{OUT}} = -14.5\text{ V to } +14.5\text{ V}$		17		mA
Short Circuit Current	Sourcing to $0\text{ V}$		80		mA
	Sinking to $0\text{ V}$		60		mA
Capacitive Load Drive	$G = +1$		500		pF
<b>POWER SUPPLY</b>					
Operating Range		+3		+36	V
Quiescent Current	$T_{\text{MIN}}$ to $T_{\text{MAX}}$ , Total		7.0	8.4	mA
Power Supply Rejection Ratio	$V_S = +5\text{ V to } +15\text{ V}$ , $T_{\text{MIN}}$ to $T_{\text{MAX}}$	70	80		dB

Specification subject to change without notice.

## ABSOLUTE MAXIMUM RATINGS<sup>1</sup>

Supply Voltage . . . . . +36 V  
 Internal Power Dissipation<sup>2</sup>  
     Plastic Package (N) . . . . . 1.3 Watts  
     Small Outline Package (R) . . . . . 0.9 Watts  
 Input Voltage (Common Mode) . . . . .  $\pm V_S$   
 Differential Input Voltage . . . . .  $\pm 1.2$  V  
 Output Short Circuit Duration  
     . . . . . Observe Power Derating Curves  
 Storage Temperature Range N, R . . . . .  $-65^{\circ}\text{C}$  to  $+125^{\circ}\text{C}$   
 Operating Temperature Range . . . . .  $-40^{\circ}\text{C}$  to  $+85^{\circ}\text{C}$   
 Lead Temperature Range (Soldering 10 sec) . . . . .  $+300^{\circ}\text{C}$

## NOTES

<sup>1</sup>Stresses above those listed under “Absolute Maximum Ratings” may cause permanent damage to the device. This is a stress rating only and functional operation of the device at these or any other conditions above those indicated in the operational section of this specification is not implied. Exposure to absolute maximum rating conditions for extended periods may affect device reliability.

<sup>2</sup>Specification is for device in free air:

8-Pin Plastic Package:  $\theta_{JA} = 90^{\circ}\text{C}/\text{Watt}$

8-Pin SOIC Package:  $\theta_{JA} = 160^{\circ}\text{C}/\text{Watt}$

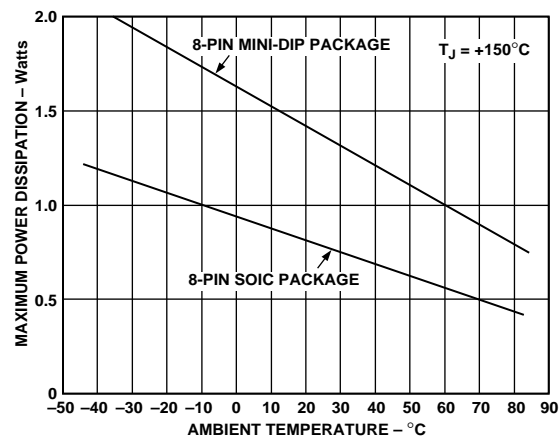

Figure 3. Maximum Power Dissipation vs. Temperature

## ORDERING GUIDE

Model	Temperature Range	Package Description	Package Option
AD823AN	$-40^{\circ}\text{C}$ to $+85^{\circ}\text{C}$	8-Pin Plastic DIP	N-8
AD823AR	$-40^{\circ}\text{C}$ to $+85^{\circ}\text{C}$	8-Pin Plastic SOIC	SO-8
AD823AR-REEL	$-40^{\circ}\text{C}$ to $+85^{\circ}\text{C}$	SOIC on Reel	SO-8

## CAUTION

ESD (electrostatic discharge) sensitive device. Electrostatic charges as high as 4000 V readily accumulate on the human body and test equipment and can discharge without detection. Although the AD823 features proprietary ESD protection circuitry, permanent damage may occur on devices subjected to high energy electrostatic discharges. Therefore, proper ESD precautions are recommended to avoid performance degradation or loss of functionality.



# AD823—Typical Characteristics

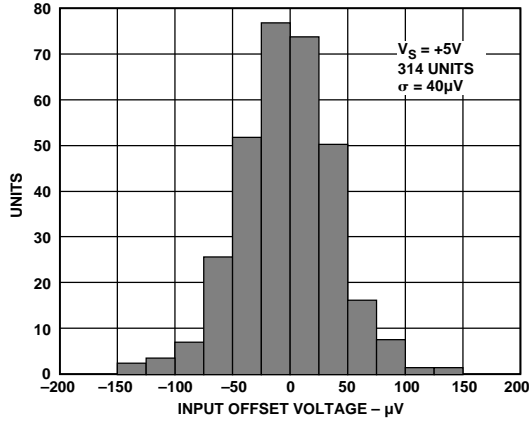

Figure 4. Typical Distribution of Input Offset Voltage

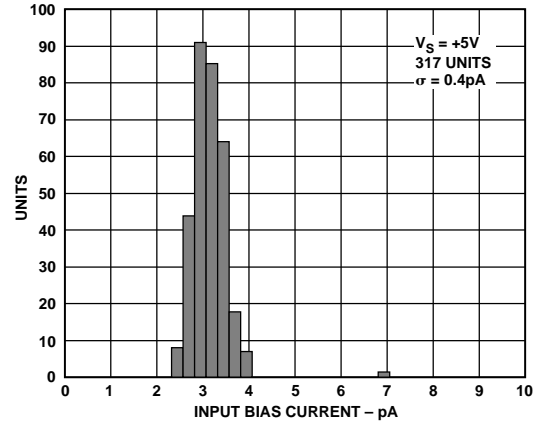

Figure 7. Typical Distribution of Input Bias Current

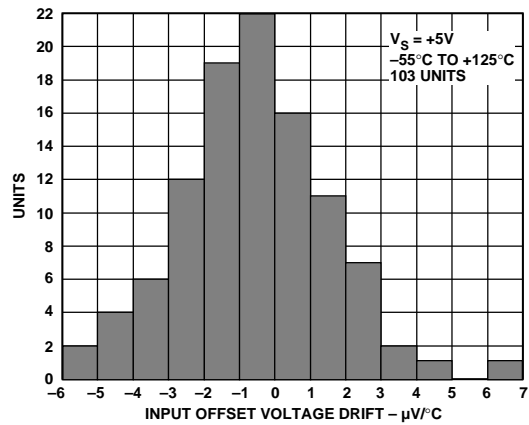

Figure 5. Typical Distribution of Input Offset Voltage Drift

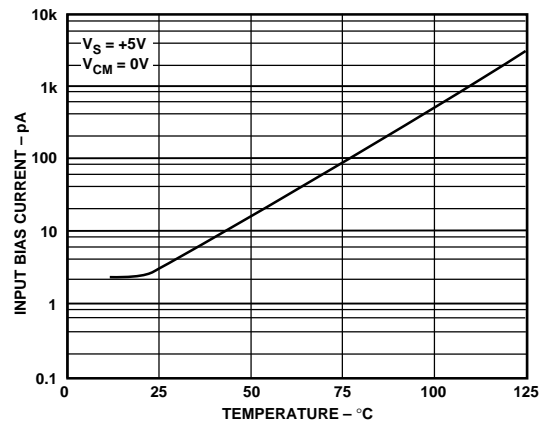

Figure 8. Input Bias Current vs. Temperature

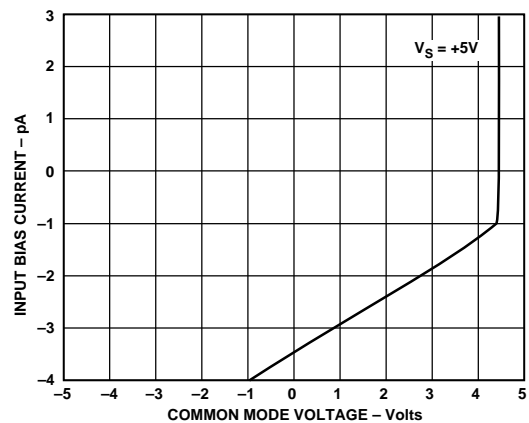

Figure 6. Input Bias Current vs. Common-Mode Voltage

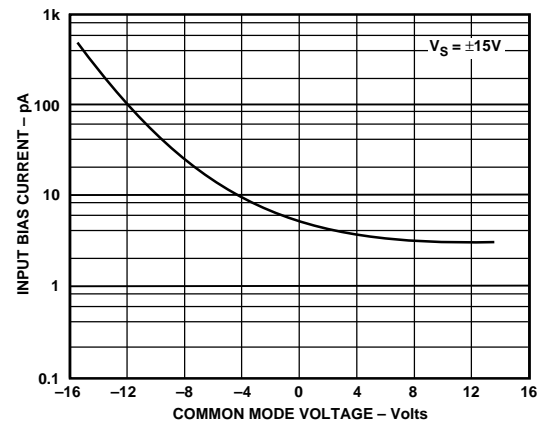

Figure 9. Input Bias Current vs. Common-Mode Voltage

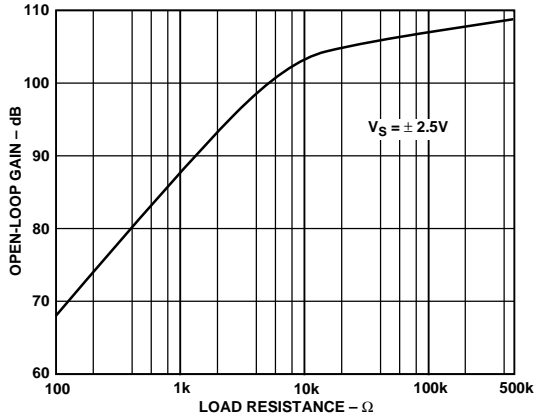

Figure 10. Open-Loop Gain vs. Load Resistance

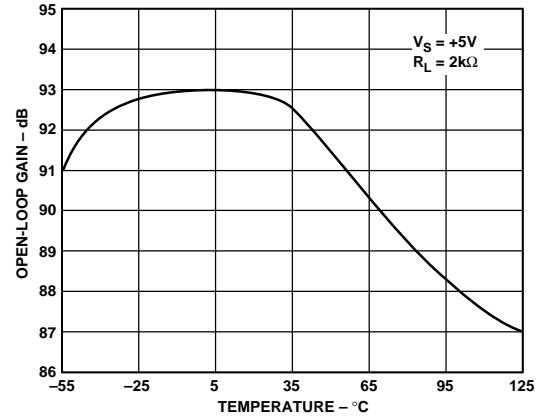

Figure 13. Open-Loop Gain vs. Temperature

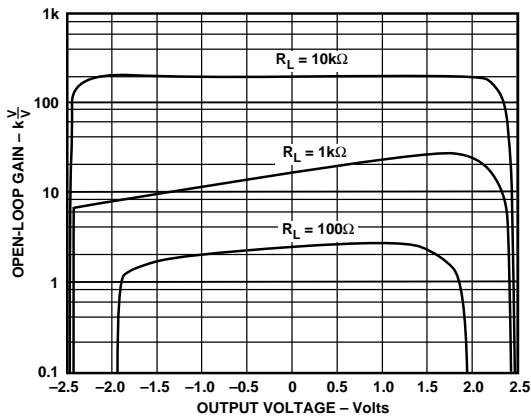

Figure 11. Open-Loop Gain vs. Output Voltage,  $V_S = \pm 2.5V$

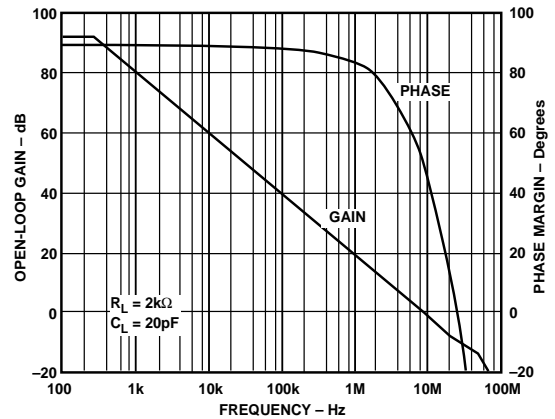

Figure 14. Open-Loop Gain and Phase vs. Frequency

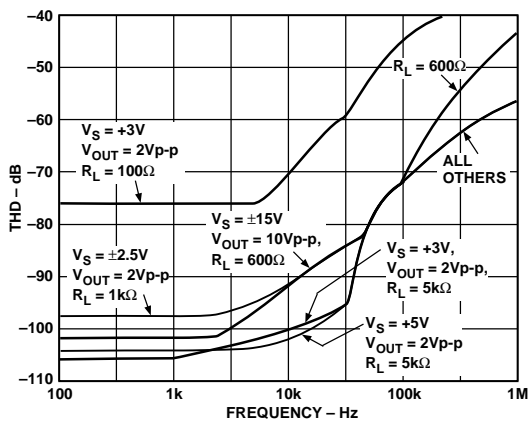

Figure 12. Total Harmonic Distortion vs. Frequency

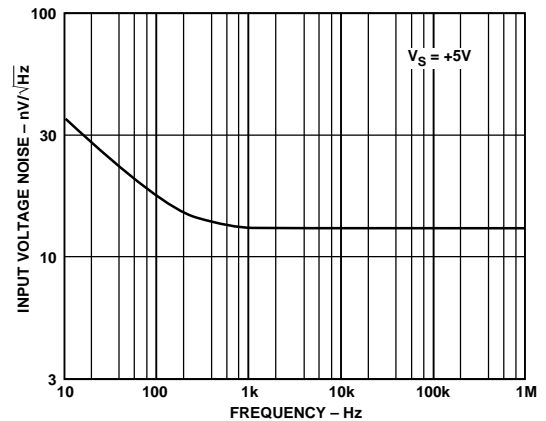

Figure 15. Input Voltage Noise vs. Frequency

# AD823—Typical Characteristics

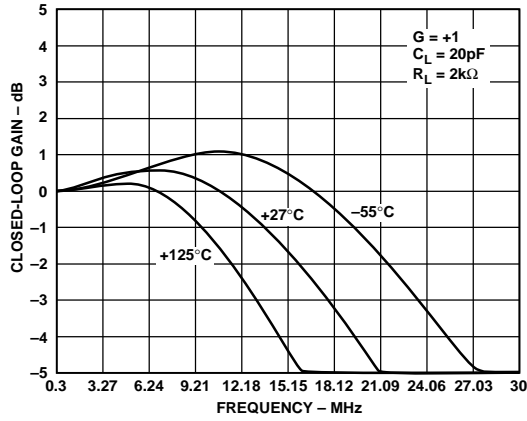

Figure 16. Closed Loop Gain vs. Frequency

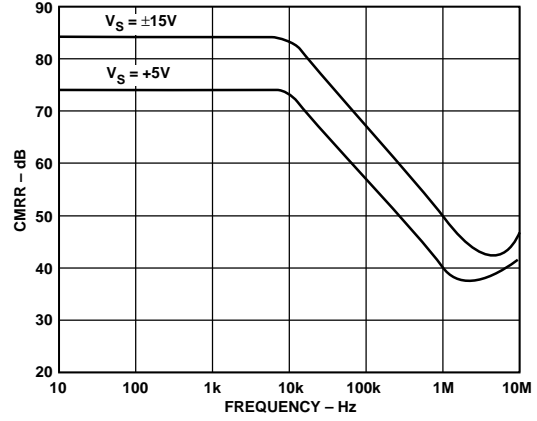

Figure 19. Common-Mode Rejection vs. Frequency

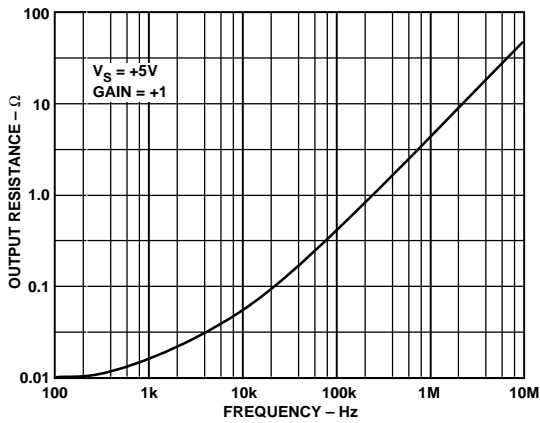

Figure 17. Output Resistance vs. Frequency,  $V_S = 5\text{V}$ , Gain = +1

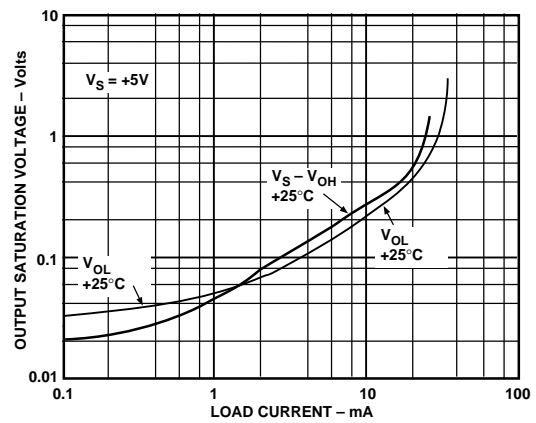

Figure 20. Output Saturation Voltage vs. Load Current

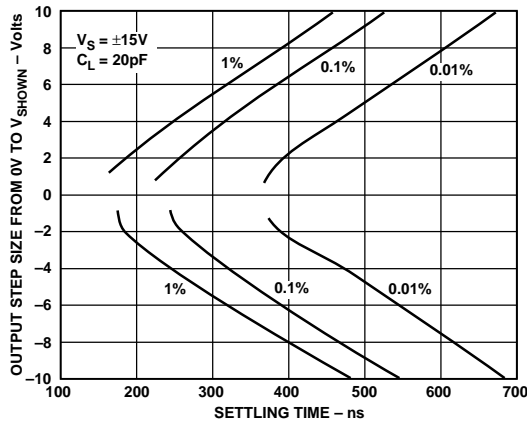

Figure 18. Inverter Settling Time vs. Output Step Size

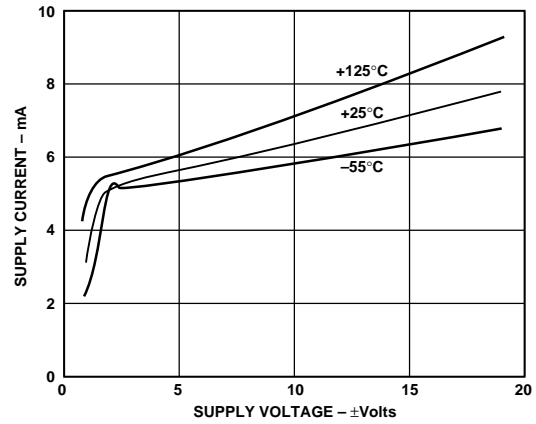

Figure 21. Quiescent Current vs. Supply Voltage



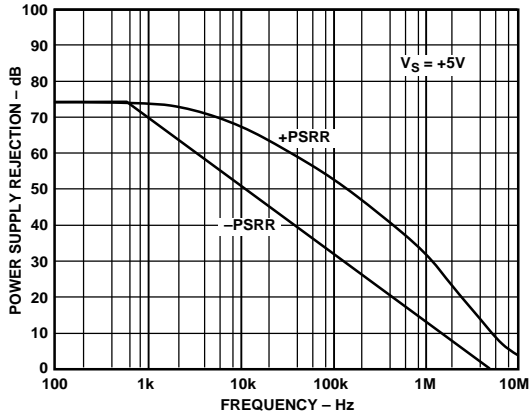

Figure 22. Power Supply Rejection vs. Frequency

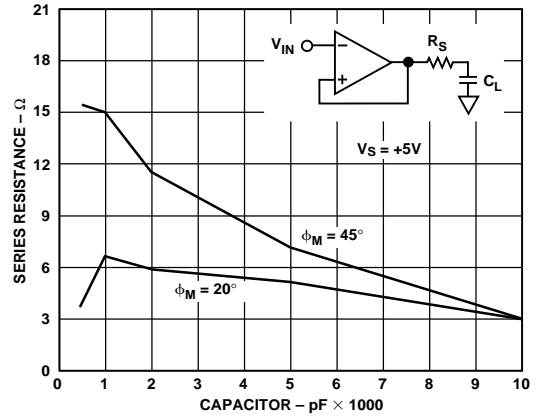

Figure 25. Capacitive Load vs. Series Resistance

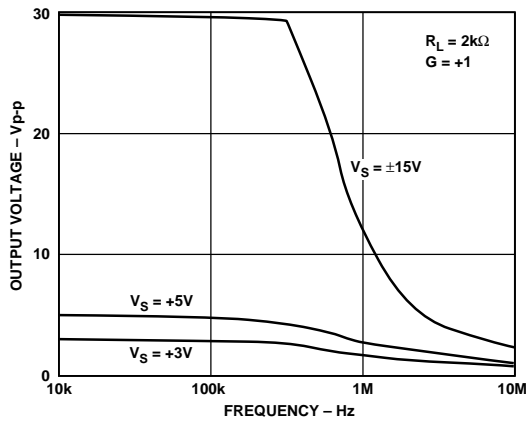

Figure 23. Large Signal Frequency Response

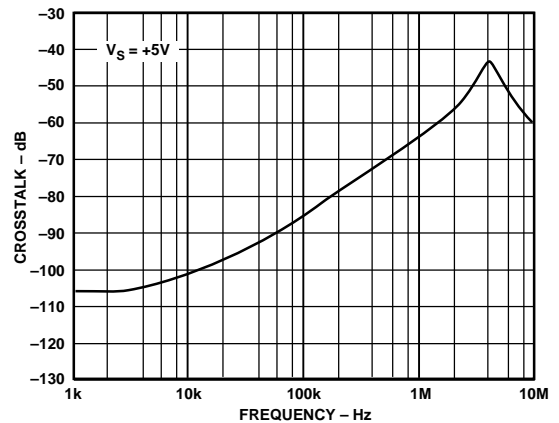

Figure 26. Crosstalk vs. Frequency

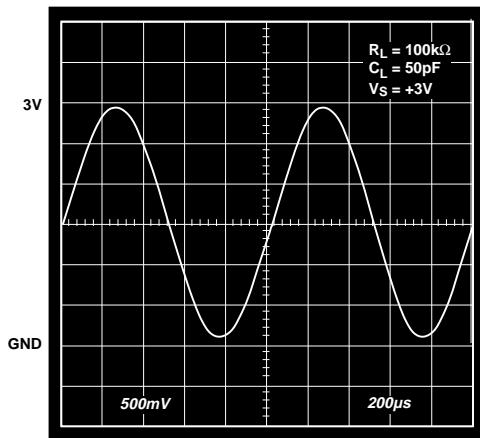

Figure 24. Output Swing,  $V_S = +3V$ ,  $G = +1$

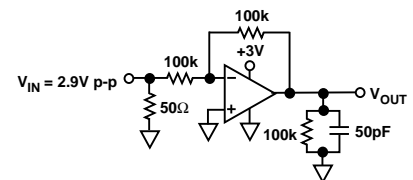
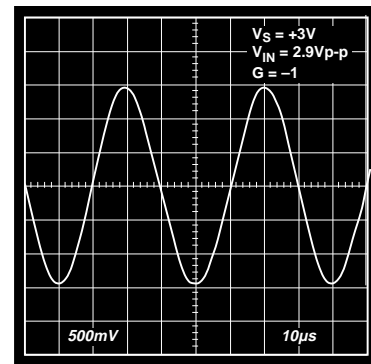

Figure 27. Output Swing,  $V_S = +3V$ ,  $G = -1$

# AD823—Typical Characteristics

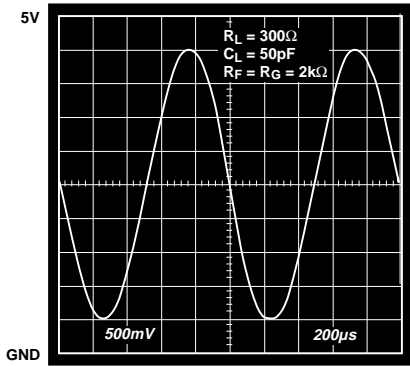

Figure 28. Output Swing,  $V_S = +5\text{ V}$ ,  $G = -1$

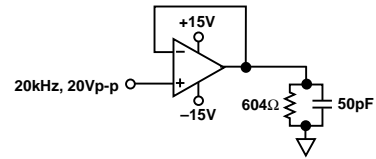
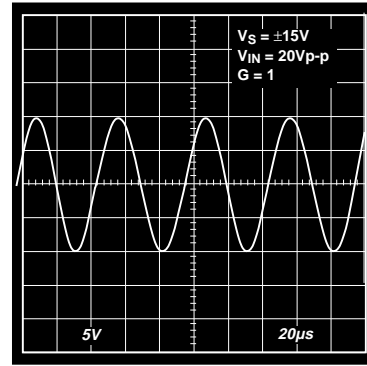

Figure 31. Output Swing,  $V_S = \pm 15\text{ V}$ ,  $G = +1$

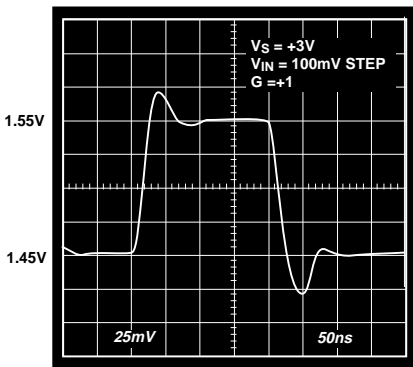

Figure 29. Pulse Response,  $V_S = +3\text{ V}$ ,  $G = +1$

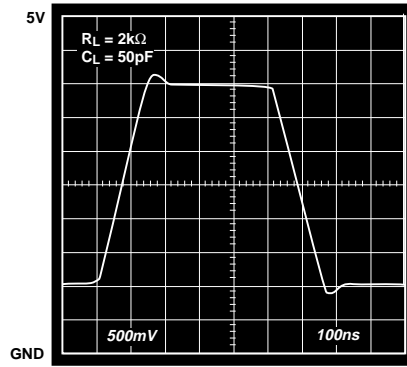

Figure 32. Pulse Response,  $V_S = +5\text{ V}$ ,  $G = +1$

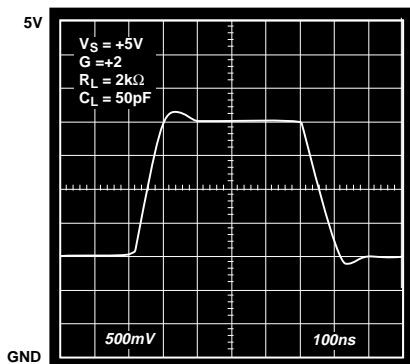

Figure 30. Pulse Response,  $V_S = +5\text{ V}$ ,  $G = +2$

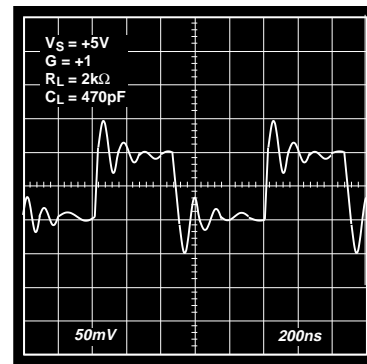

Figure 33. Pulse Response,  $V_S = +5\text{ V}$ ,  $G = +1$ ,  $C_L = 470\text{ pF}$

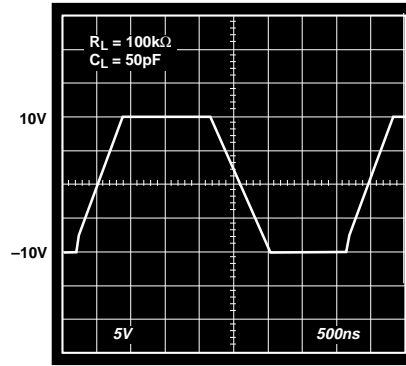

Figure 34. Pulse Response,  $V_S = \pm 15\text{ V}$ ,  $G = +1$

**THEORY OF OPERATION**

This AD823 is fabricated on Analog Devices’ proprietary complementary bipolar (CB) process that enables the construction of pnp and npn transistors with similar  $f_T$ s in the 600 MHz to 800 MHz region. In addition, the process also features N-channel JFETs, which are used in the input stage of the AD823. These process features allow the construction of high frequency, low distortion op amps with picoampere input currents. This design uses a differential-output input stage to maximize bandwidth and headroom (see Figure 35). The smaller signal swings required on the S1P, S1N outputs reduce the effect of nonlinear currents due to junction capacitances and improve the distortion performance. With this design harmonic distortion of better than  $-91\text{ dB @ }20\text{ kHz}$  into  $600\ \Omega$  with  $V_{OUT} = 4\text{ V p-p}$  on a single 5 volt supply is achieved. The complementary common-emitter design of the output stage provides excellent load drive without the need for emitter followers, thereby improving the output range of the device considerably with respect to conventional op amps. The AD823 can drive 20 mA with the outputs within 0.6 V of the supply rails. The AD823 also offers outstanding precision for a high speed op amp. Input offset voltages

of 1 mV max and offset drift of  $2\ \mu\text{V}/^\circ\text{C}$  are achieved through the use of Analog Devices’ advanced thin-film trimming techniques.

A “Nested Integrator” topology is used in the AD823 (see small-signal schematic shown in Figure 36). The output stage can be modeled as an ideal op amp with a single-pole response and a unity-gain frequency set by transconductance  $g_{m2}$  and capacitor C2. R1 is the output resistance of the input stage;  $g_m$  is the input transconductance. C1 and C5 provide Miller compensation for the overall op amp. The unity gain frequency will occur at  $g_m/C5$ . Solving the node equations for this circuit yields:

$$\frac{V_{OUT}}{V_i} = \frac{A_0}{(sR1[C1(A2 + 1)] + 1) \times \left( s \left[ \frac{g_{m2}}{C2} \right] + 1 \right)}$$

where:

$A_0 = g_m g_{m2} R_2 R_1$  (Open Loop Gain of Op Amp)

$A_2 = g_{m2} R_2$  (Open Loop Gain of Output Stage)

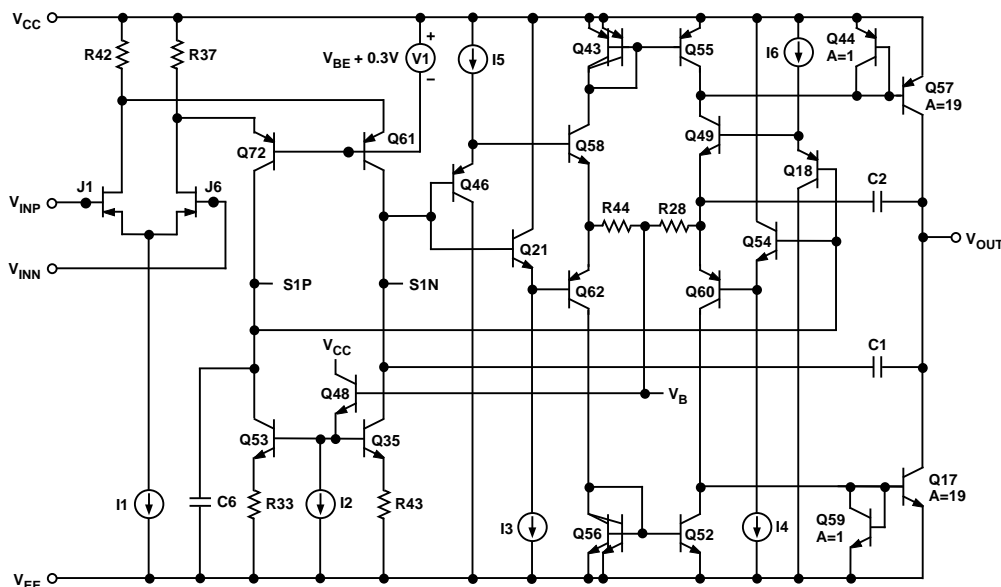

Figure 35. Simplified Schematic

# AD823

The first pole in the denominator is the dominant pole of the amplifier, and occurs at about 18 Hz. This equals the input stage output impedance  $R1$  multiplied by the Miller-multiplied value of  $C1$ . The second pole occurs at the unity-gain bandwidth of the output stage, which is 23 MHz. This type of architecture allows more open loop gain and output drive to be obtained than a standard two-stage architecture would allow.

## OUTPUT IMPEDANCE

The low frequency open loop output impedance of the common-emitter output stage used in this design is approximately 30 k $\Omega$ . While this is significantly higher than a typical emitter follower output stage, when connected with feedback the output impedance is reduced by the open loop gain of the op amp. With 109 dB of open loop gain the output impedance is reduced to less than 0.2  $\Omega$ . At higher frequencies the output impedance will rise as the open loop gain of the op amp drops; however, the output also becomes capacitive due to the integrator capacitors  $C1$  and  $C2$ . This prevents the output impedance from ever becoming excessively high (see Figure 17), which can cause stability problems when driving capacitive loads. In fact, the AD823 has excellent cap-load drive capability for a high frequency op amp. Figure 33 shows the AD823 connected as a follower while driving 470 pF direct capacitive load. Under these conditions the phase margin is approximately 20°. If greater phase margin is desired a small resistor can be used in series with the output to decouple the effect of the load capacitance from the op amp (see Figure 25). In addition, running the part at higher gains will also improve the capacitive load drive capability of the op amp.

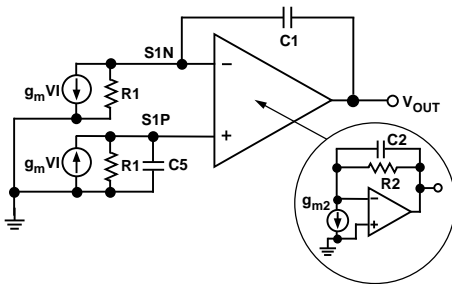

Figure 36. Small Signal Schematic

## APPLICATION NOTES

### INPUT CHARACTERISTICS

In the AD823, n-channel JFET's are used to provide a low offset, low noise, high impedance input stage. Minimum input common-mode voltage extends from 0.2 V below  $-V_S$  to 1 V less than  $+V_S$ . Driving the input voltage closer to the positive rail will cause a loss of amplifier bandwidth and increased common-mode voltage error.

The AD823 does not exhibit phase reversal for input voltages up to and including  $+V_S$ . Figure 37a shows the response of an AD823 voltage follower to a 0 V to +5 V ( $+V_S$ ) square wave input. The input and output are superimposed. The output polarity tracks the input polarity up to  $+V_S$ —no phase reversal. The reduced bandwidth above a 4 V input causes the rounding of the output wave form. For input voltages greater than  $+V_S$ , a resistor in series with the AD823's plus input will prevent phase reversal, at the expense of greater input voltage noise. This is illustrated in Figure 37b.

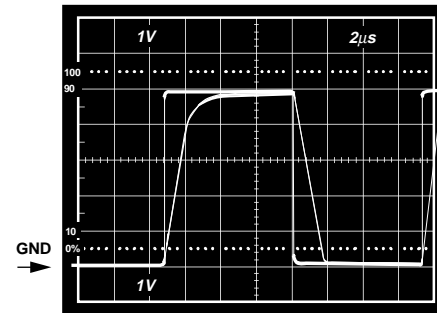

a. Response with  $R_P = 0$ ;  $V_{IN}$  from 0 to  $V_S$

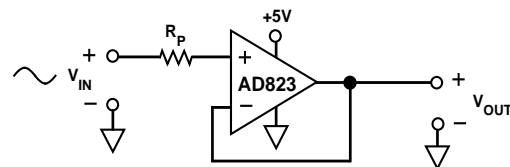
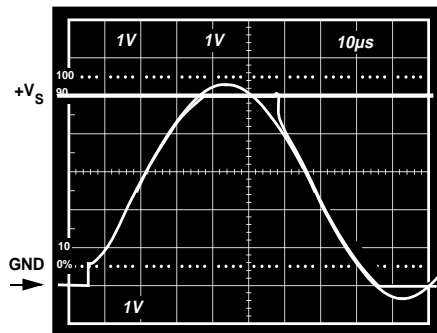

b.  $V_{IN} = 0$  to  $+V_S + 200$  mV;  $V_{OUT} = 0$  to  $+V_S$ ;  $R_P = 49.9$  k $\Omega$

Figure 37. AD823 Input Response

Since the input stage uses n-channel JFETs, input current during normal operation is negative; the current flows out from the input terminals. If the input voltage is driven more positive than  $+V_S - 0.4\text{ V}$ , the input current will reverse direction as internal device junctions become forward biased. This is illustrated in Figure 6.

A current limiting resistor should be used in series with the input of the AD823 if there is a possibility of the input voltage exceeding the positive supply by more than 300 mV, or if an input voltage will be applied to the AD823 when  $\pm V_S = 0$ . The amplifier will be damaged if left in that condition for more than 10 seconds. A 1 k $\Omega$  resistor allows the amplifier to withstand up to 10 volts of continuous overvoltage, and increases the input voltage noise by a negligible amount.

Input voltages less than  $-V_S$  are a completely different story. The amplifier can safely withstand input voltages 20 volts below the minus supply voltage as long as the total voltage from the positive supply to the input terminal is less than 36 volts. In addition, the input stage typically maintains picoamp level input currents across that input voltage range.

The AD823 is designed for  $16\text{ nV}/\sqrt{\text{Hz}}$  wideband input voltage noise and maintains low noise performance to low frequencies (refer to Figure 15). This noise performance, along with the AD823's low input current and current noise means that the AD823 contributes negligible noise for applications with source resistances greater than 10 k $\Omega$  and signal bandwidths greater than 1 kHz.

## OUTPUT CHARACTERISTICS

The AD823's unique bipolar rail-to-rail output stage swings within 25 mV of the supplies with no external resistive load. The AD823's approximate output saturation resistance is 25  $\Omega$  sourcing and sinking. This can be used to estimate output saturation voltage when driving heavier current loads. For instance, when driving 5 mA, the saturation voltage to the rails will be approximately 125 mV.

If the AD823's output is driven hard against the output saturation voltage, it will recover within 250 ns of the input returning to the amplifier's linear operating region.

## A/D Driver

The rail-to-rail output of the AD823 makes it useful as an A/D driver in a single supply system. Because it is a dual op amp, it can be used to drive both the analog input of the A/D along with its reference input. The high impedance FET input of the AD823 is well suited for minimally loading of high output impedance devices.

Figure 38 shows a schematic of an AD823 being used to drive both the input and reference input of an AD1672, a 12-bit 3 MSPS single supply A/D converter. One amplifier is configured as a unity gain follower to drive the analog input of the AD1672 which is configured to accept an input voltage that ranges from 0 to 2.5 V.

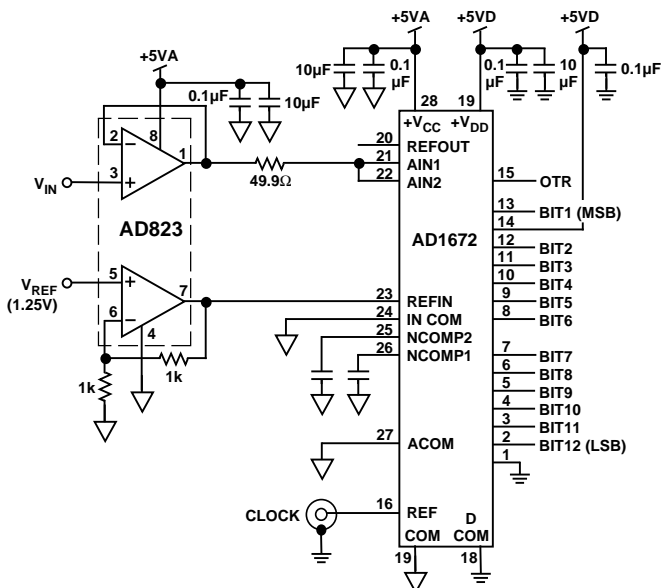

Figure 38. AD823 Driving Input and Reference of the AD1672, a 12-Bit 3 MSPS A/D Converter

The other amplifier is configured as a gain of two to drive the reference input from a 1.25 V reference. Although the AD1672 has its own internal reference, there are systems that require greater accuracy than the internal reference provides. On the other hand, if the AD1672 internal reference is used, the second AD823 amplifier can be used to buffer the reference voltage for driving other circuitry while minimally loading the reference source.

The circuit was tested with a 500 kHz sine wave input that was heavily low pass filtered (60 dB) to minimize the harmonic content at the input to the AD823. The digital output of the AD1672 was analyzed by performing an FFT.

During the testing, it was observed that at 500 kHz, the output of the AD823 cannot go below about 350 mV (operating with negative supply at ground) without seriously degrading the second harmonic distortion. Another test was performed with a 200  $\Omega$  pull-down resistor to ground that allowed the output to go as low as 200 mV without seriously affecting the second harmonic distortion. There was, however, a slight increase in the third harmonic term with the resistor added, but it was still less than the second harmonic.

# AD823

Figure 39 is an FFT plot of the results of driving the AD1672 with the AD823 with no pull-down resistor. The input amplitude was 2.15 V p-p and the lower voltage excursion was 350 mV. The input frequency was 490 kHz, which was chosen to spread the location of the harmonics.

The distortion analysis is important for systems requiring good frequency domain performance. Other systems may require good time domain performance. The noise and settling time performance of the AD823 will provide the necessary information for its applicability for these systems.

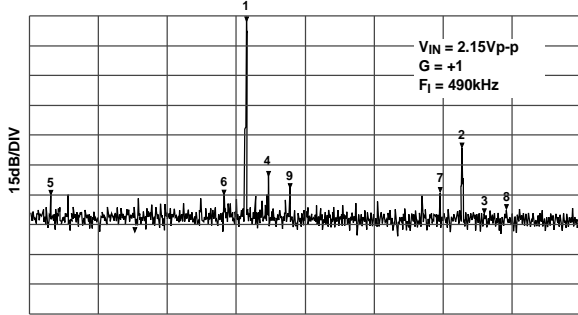

Figure 39. FFT of AD1672 Output Driven by AD823

### 3 Volt, Single Supply Stereo Headphone Driver

The AD823 exhibits good current drive and THD+N performance, even at 3 V single supplies. At 20 kHz, total harmonic distortion plus noise (THD+N) equals -62 dB (0.079%) for a 300 mV p-p output signal. This is comparable to other single supply op amps which consume more power and cannot run on 3 V power supplies.

In Figure 40, each channel's input signal is coupled via a 1 μF Mylar capacitor. Resistor dividers set the dc voltage at the non-inverting inputs so that the output voltage is midway between the power supplies (+1.5 V). The gain is 1.5. Each half of the AD823 can then be used to drive a headphone channel. A 5 Hz high-pass filter is realized by the 500 μF capacitors and the headphones, which can be modeled as 32 ohm load resistors to ground. This ensures that all signals in the audio frequency range (20 Hz-20 kHz) are delivered to the headphones.

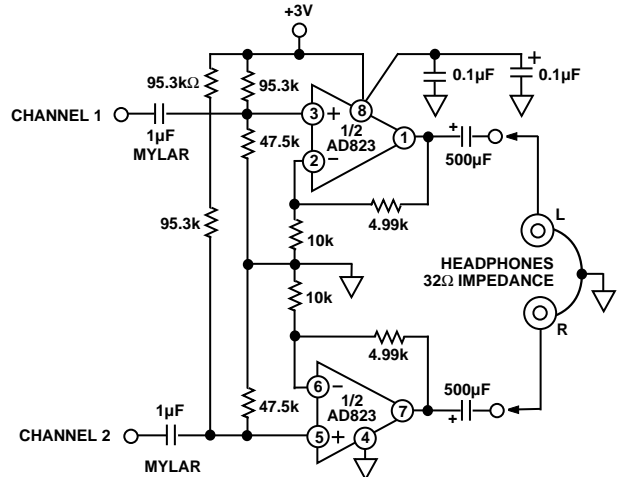

Figure 40. 3 Volt Single Supply Stereo Headphone Driver

### Second Order Low-Pass Filter

Figure 41 depicts the AD823 configured as a second order Butterworth low-pass filter. With the values as shown, the corner frequency will be 200 kHz. The equations for component selection are shown below:

$R1 = R2 =$  user selected (typical values: 10 kΩ to 100 kΩ).

$$C1(\text{farads}) = \frac{1.414}{2\pi f_{\text{cutoff}} R1}; C2 = \frac{0.707}{2\pi f_{\text{cutoff}} R1}$$

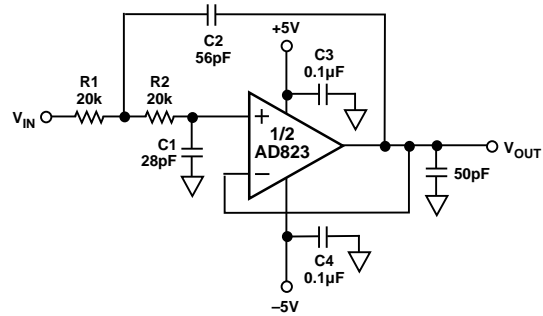

Figure 41. Second Order Low-Pass Filter

A plot of the filter is shown below; better than 50 dB of high frequency rejection is provided.

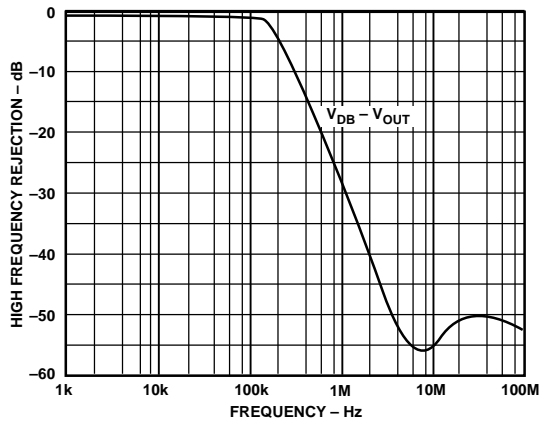

Figure 42. Frequency Response of Filter

**Single-Supply Half-Wave and Full-Wave Rectifiers**

An AD823 configured as a unity gain follower and operated with a single supply can be used as a simple half-wave rectifier. The AD823's inputs maintain picoamp level input currents even when driven well below the minus supply. The rectifier puts that behavior to good use, maintaining an input impedance of over  $10^{11} \Omega$  for input voltages from 1 volt from the positive supply to 20 volts below the negative supply.

The full- and half-wave rectifier shown in Figure 43 operates as follows: when  $V_{IN}$  is above ground,  $R1$  is bootstrapped through the unity gain follower A1 and the loop of amplifier A2. This forces the inputs of A2 to be equal, thus no current flows through  $R1$  or  $R2$ , and the circuit output tracks the input. When  $V_{IN}$  is below ground, the output of A1 is forced to ground. The noninverting input of amplifier A2 sees the ground level output of A1, therefore, A2 operates as a unity gain inverter. The out-

put at node C is then a full-wave rectified version of the input. Node B is a buffered half-wave rectified version of the input. Input voltage supply to  $\pm 18$  volts can be rectified, depending on the voltage supply used.

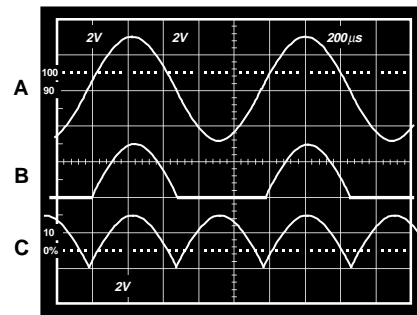
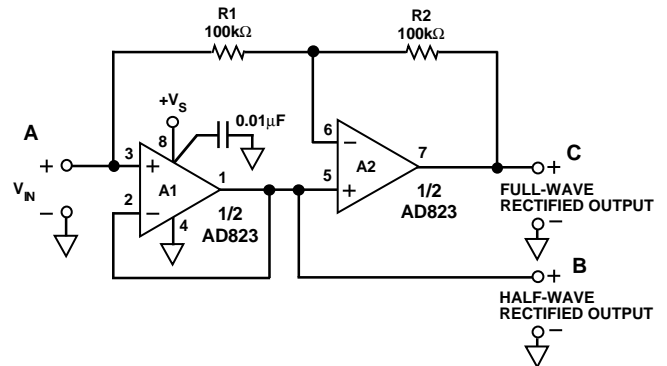
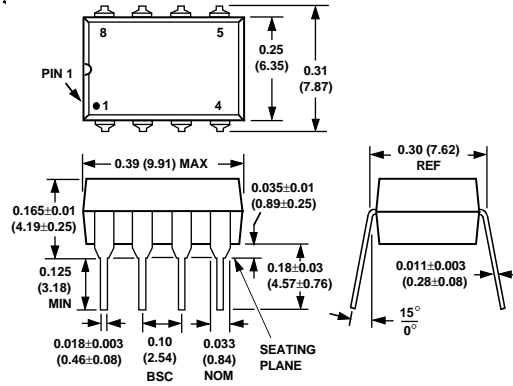

Figure 43. Single Supply Half- and Full-Wave Rectifier

**OUTLINE DIMENSIONS**

Dimensions shown in inches and (mm).

**8-Lead Plastic DIP  
(N-8)**



**8-Lead Plastic SOIC  
(SO-8)**

