

**FEATURES**

**Four Complete Voltage Output DACs**  
**Data Register Readback Feature**  
**"Reset to Zero" Override**  
**Multiplying Operation**  
**Double-Buffered Latches**  
**Surface Mount and DIP Packages**  
**MIL-STD-883 Compliant Versions Available**

**APPLICATIONS**

**Automatic Test Equipment**  
**Robotics**  
**Process Control**  
**Disk Drives**  
**Instrumentation**  
**Avionics**

**PRODUCT DESCRIPTION**

The AD664 is four complete 12-bit, voltage-output DACs on one monolithic IC chip. Each DAC has a double-buffered input latch structure and a data readback function. All DAC read and write operations occur through a single microprocessor-compatible I/O port.

The I/O port accommodates 4-, 8- or 12-bit parallel words allowing simple interfacing with a wide variety of microprocessors. A reset to zero control pin is provided to allow a user to simultaneously reset all DAC outputs to zero, regardless of the contents of the input latch. Any one or all of the DACs may be placed in a transparent mode allowing immediate response by the outputs to the input data.

The analog portion of the AD664 consists of four DAC cells, four output amplifiers, a control amplifier and switches. Each DAC cell is an inverting R-2R type. The output current from each DAC is switched to the on-board application resistors and output amplifier. The output range of each DAC cell is programmed through the digital I/O port and may be set to unipolar or bipolar range, with a gain of one or two times the reference voltage. All DACs are operated from a single external reference.

The functional completeness of the AD664 results from the combination of Analog Devices' BiMOS II process, laser-trimmed thin-film resistors and double-level metal interconnects.

**PRODUCT HIGHLIGHTS**

1. The AD664 provides four voltage-output DACs on one chip offering the highest density 12-bit D/A function available.
2. The output range of each DAC is fully and independently programmable.
3. Readback capability allows verification of contents of the internal data registers.

**REV. C**

Information furnished by Analog Devices is believed to be accurate and reliable. However, no responsibility is assumed by Analog Devices for its use, nor for any infringements of patents or other rights of third parties which may result from its use. No license is granted by implication or otherwise under any patent or patent rights of Analog Devices.

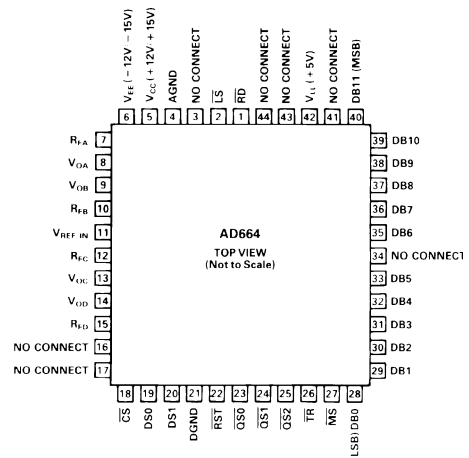
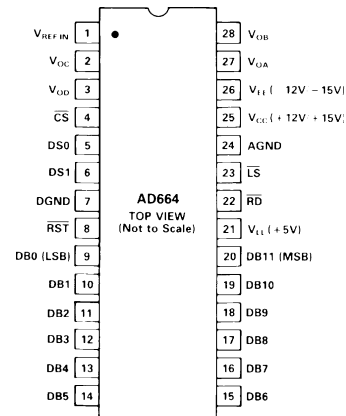
**PIN CONFIGURATIONS**
**44-Pin Package**

**28-Pin DIP Package**

4. The asynchronous RESET control returns all D/A outputs to zero volts.
5. DAC-to-DAC matching performance is specified and tested.
6. Linearity error is specified to be 1/2 LSB at room temperature and 3/4 LSB maximum for the K, B and T grades.
7. DAC performance is guaranteed to be monotonic over the full operating temperature range.
8. Readback buffers have tristate outputs.
9. Multiplying-mode operation allows use with fixed or variable, positive or negative external references.
10. The AD664 is available in versions compliant with MIL-STD-883. Refer to the Analog Devices Military Products Databook or current AD664/883B data sheet for detailed specifications.

# AD664—SPECIFICATIONS ( $V_{LL} = +5\text{ V}$ , $V_{CC} = +15\text{ V}$ , $V_{EE} = -15\text{ V}$ , $V_{REF} = +10\text{ V}$ , $T_A = +25^\circ\text{C}$ unless otherwise noted)

Model	JN/JP/AD/AJ/SD			KN/KP/BD/BJ/BE/TD/TE			Units
	Min	Typ	Max	Min	Typ	Max	
RESOLUTION		12	12		*	*	Bits
ANALOG OUTPUT							
Voltage Range <sup>1</sup>							
UNI Versions	0		$V_{CC} - 2.0^2$	*		*	Volts
BIP Versions	$V_{EE} + 2.0^2$		$V_{CC} - 2.0^2$	*		*	Volts
Output Current	5			*			mA
Load Resistance		2			*		k $\Omega$
Load Capacitance			500			*	pF
Short-Circuit Current		25	40		*	*	mA
ACCURACY							
Gain Error	-7	$\pm 3$	7	-5	$\pm 2$	5	LSB
Unipolar Offset	-2	$\pm 1/2$	2	-1	$\pm 1/4$	1	LSB
Bipolar Zero <sup>3</sup>	-3	$\pm 3/4$	3	-2	$\pm 1/2$	2	LSB
Linearity Error <sup>4</sup>	-3/4	$\pm 1/2$	3/4	-1/2	$\pm 1/4$	1/2	LSB
Linearity $T_{MIN}$ to $T_{MAX}$	-1	$\pm 3/4$	1	-3/4	$\pm 1/2$	3/4	LSB
Differential Linearity	-3/4		3/4	-1/2		1/2	LSB
Differential Linearity $T_{MIN}$ to $T_{MAX}$	<b>Monotonic @ All Temperatures</b>			<b>Monotonic @ All Temperatures</b>			
Gain Error Drift							
Unipolar 0 V to +10 V Mode	-12	$\pm 7$	12	-10	$\pm 5$	10	ppm of FSR <sup>5</sup> /°C
Bipolar -5 V to +5 V Mode	-12	$\pm 7$	12	-10	$\pm 5$	10	ppm of FSR/°C
Bipolar -10 V to +10 V Mode	-12	$\pm 7$	12	-10	$\pm 5$	10	ppm of FSR/°C
Unipolar Offset Drift							
Unipolar 0 V to +10 V Mode	-3	$\pm 1.5$	3	-2	$\pm 1$	2	ppm of FSR/°C
Bipolar Zero Drift							
Bipolar -5 V to +5 V Mode	-12	$\pm 7$	12	-10	$\pm 5$	10	ppm of FSR/°C
Bipolar -10 V to +10 V Mode	-12	$\pm 7$	12	-10	$\pm 5$	10	ppm of FSR/°C
REFERENCE INPUT							
Input Resistance	1.3		2.6	*		*	k $\Omega$
Voltage Range <sup>6</sup>	$V_{EE} + 2.0^2$		$V_{CC} - 2.0^2$	*		*	Volts
POWER REQUIREMENTS							
$V_{LL}$	4.5	5.0	5.5	*	*	*	Volts
$I_{LL}$							
@ $V_{IH}$ , $V_{IL} = 5\text{ V}$ , 0 V		0.1	1		*	*	mA
@ $V_{IH}$ , $V_{IL} = 2.4\text{ V}$ , 0.4 V		3	6		*	*	mA
$V_{CC}/V_{EE}$	$\pm 11.4$		$\pm 16.5$	*		*	Volts
$I_{CC}$		12	15		*	*	mA
$I_{EE}$		15	19		*	*	mA
Total Power		400	525		*	*	mW
ANALOG GROUND CURRENT <sup>7</sup>	-600	$\pm 400$	+600	*	*	*	$\mu\text{A}$
MATCHING PERFORMANCE							
Gain <sup>8</sup>	-6	$\pm 3$	6	-4	$\pm 2$	4	LSB
Offset <sup>9</sup>	-2	$\pm 1/2$	2	-1	$\pm 1/4$	1	LSB
Bipolar Zero <sup>10</sup>	-3	$\pm 1$	3	-2	$\pm 1$	2	LSB
Linearity <sup>11</sup>	-1.5	$\pm 1/2$	1.5	-1	$\pm 1/2$	1	LSB
CROSSTALK							
Analog			-90			*	dB
Digital			-60			*	dB
DYNAMIC PERFORMANCE ( $R_L = 2\text{ k}\Omega$ , $C_L = 500\text{ pF}$ )							
Settling Time to $\pm 1/2$ LSB							
Off $\leftarrow$ Bits $\rightarrow$ On, GAIN = 1, $V_{REF} = 10$		8	10		*	*	$\mu\text{s}$
Settling Time to $\pm 1/2$ LSB							
-10 $\leftarrow$ $V_{REF}$ $\rightarrow$ 10 V, GAIN = 1, Bits On		10			*		$\mu\text{s}$
Glitch Impulse			500			*	nV-sec
MULTIPLYING MODE PERFORMANCE							
Reference Feedthrough @ 1 kHz		-75			*		dB
Reference -3 dB Bandwidth		70			*		kHz
POWER SUPPLY GAIN SENSITIVITY							
11.4 V $\leftarrow$ $V_{CC}$ $\rightarrow$ 16.5 V		$\pm 2$	$\pm 5$		*	*	ppm/%
-16.5 V $\leftarrow$ $V_{EE}$ $\rightarrow$ -11.4 V		$\pm 2$	$\pm 5$		*	*	ppm/%
4.5 V $\leftarrow$ $V_{LL}$ $\rightarrow$ 5.5 V		$\pm 2$	$\pm 5$		*	*	ppm/%

Model	JN/JP/AD/AJ/SD			KN/KP/BD/BJ/BE/TD/TE			Units
	Min	Typ	Max	Min	Typ	Max	
<b>DIGITAL INPUTS</b>							
$V_{IH}$	<b>2.0</b>			*			Volts
$V_{IL}$	<b>0</b>		<b>0.8</b>	*		*	Volts
Data Inputs							
$I_{IH} @ V_{IN} = V_{LL}$	<b>-10</b>	$\pm 1$	<b>10</b>	*	*	*	$\mu A$
$I_{IL} @ V_{IN} = DGND$	<b>-10</b>	$\pm 1$	<b>10</b>	*	*	*	$\mu A$
$\overline{CS}/DS0/DS1/\overline{RST}/RD/\overline{LS}$							
$I_{IH} @ V_{IN} = V_{LL}$	<b>-10</b>	$\pm 1$	<b>10</b>	*	*	*	$\mu A$
$I_{IL} @ V_{IN} = V_{LL}$	<b>-10</b>	$\pm 1$	<b>10</b>	*	*	*	$\mu A$
$\overline{MS}/\overline{TR}^{12}$							
$I_{IH} @ V_{IN} = V_{LL}$	<b>-10</b>	5	<b>10</b>	*	*	*	$\mu A$
$I_{IL} @ V_{IN} = DGND$	<b>-10</b>	-5	<b>0</b>	*	*	*	$\mu A$
$\overline{QS0}/\overline{QS1}/\overline{QS2}^{12}$							
$I_{IH} @ V_{IN} = V_{LL}$	<b>-10</b>	5	<b>10</b>	*	*	*	$\mu A$
$I_{IL} @ V_{IN} = DGND$	<b>-10</b>	$\pm 1$	<b>10</b>	*	*	*	$\mu A$
<b>DIGITAL OUTPUTS</b>							
$V_{OL} @ 1.6 \text{ mA Sink}$			<b>0.4</b>			*	Volts
$V_{OH} @ 0.5 \text{ mA Source}$	<b>2.4</b>			*			Volts
<b>TEMPERATURE RANGE</b>							
JN/JP/KN/KP	<b>0</b>		<b>+70</b>	*		*	$^{\circ}C$
AD/AJ/BD/BJ/BE	<b>-40</b>		<b>+85</b>	*		*	$^{\circ}C$
SD/TD/TE	<b>-55</b>		<b>+125</b>	*		*	$^{\circ}C$

**NOTES**

<sup>1</sup>A minimum power supply of  $\pm 12.0 \text{ V}$  is required for 0 V to +10 V and  $\pm 10 \text{ V}$  operation. A minimum power supply of  $\pm 11.4 \text{ V}$  is required for -5 V to +5 V operation.

<sup>2</sup>For  $V_{CC} < +12 \text{ V}$  and  $V_{EE} > -12 \text{ V}$ . Voltage not to exceed 10 V maximum.

<sup>3</sup>Bipolar zero error is the difference from the ideal output (0 volts) and the actual output voltage with code 100 000 000 000 applied to the inputs.

<sup>4</sup>Linearity error is defined as the maximum deviation of the actual DAC output from the ideal output (a straight line drawn from 0 to F.S. - 1 LSB).

<sup>5</sup>FSR means Full-Scale Range and is 20 V for  $\pm 10 \text{ V}$  range and 10 V for  $\pm 5 \text{ V}$  range.

<sup>6</sup>A minimum power supply of  $\pm 12.0 \text{ V}$  is required for a 10 V reference voltage.

<sup>7</sup>Analog Ground Current is input code dependent.

<sup>8</sup>Gain error matching is the largest difference in gain error between any two DACs in one package.

<sup>9</sup>Offset error matching is the largest difference in offset error between any two DACs in one package.

<sup>10</sup>Bipolar zero error matching is the largest difference in bipolar zero error between any two DACs in one package.

<sup>11</sup>Linearity error matching is the difference in the worst case linearity error between any two DACs in one package.

<sup>12</sup>44-pin versions only.

\*Specifications same as JN/JP/AD/AJ/SD.

Specifications subject to change without notice.

Specifications shown in **boldface** are tested on all production units at final electrical test. Results from those tests are used to calculate outgoing quality levels. All min and max specifications are guaranteed, although only those shown in boldface are tested on all production units.

**ABSOLUTE MAXIMUM RATINGS\***

$V_{LL}$ to DGND	0 V to +7 V
$V_{CC}$ to DGND	0 V to +18 V
$V_{EE}$ to DGND	-18 V to 0 V
Soldering	+300 $^{\circ}C$ , 10 sec
Power Dissipation	1000 mW
AGND to DGND	-1 V to +1 V
Reference Input	$V_{REF} \leq \pm 10 \text{ V}$ and $V_{REF} \leq (V_{CC} - 2 \text{ V}, V_{EE} + 2 \text{ V})$
$V_{CC}$ to $V_{EE}$	0 to +36 V

Digital Inputs	-0.3 V to +7 V
Analog Outputs	Indefinite Shorts to $V_{CC}, V_{LL}, V_{EE}$ and GND

\*Stresses above those listed under "Absolute Maximum Ratings" may cause permanent damage to the device. This is a stress rating only and functional operation of the device at these or any other conditions above those indicated in the operational section of this specification is not implied. Exposure to absolute maximum rating conditions for extended periods may affect device reliability.

**CAUTION**

ESD (electrostatic discharge) sensitive device. Unused devices must be stored in conductive foam or shunts. The protective foam should be discharged to the destination socket before devices are removed.



# AD664

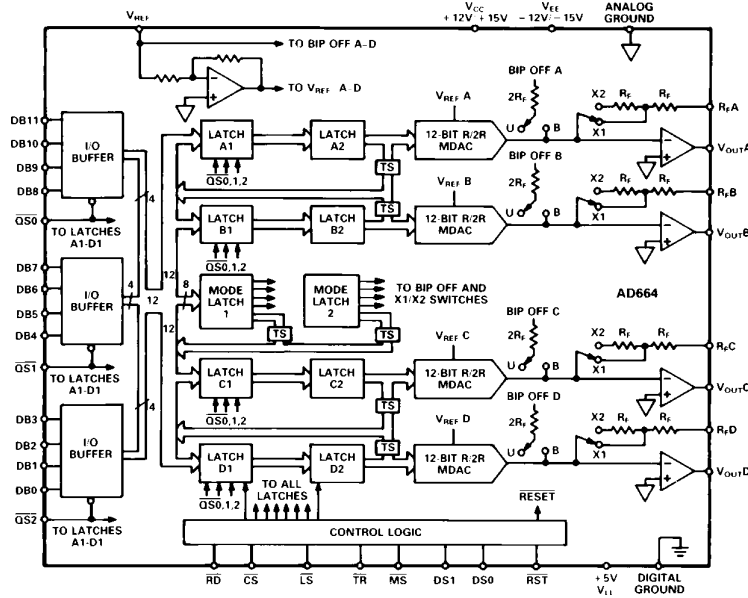

Figure 1a. 44-Pin Block Diagram

## FUNCTIONAL DESCRIPTION

The AD664 combines four complete 12-bit voltage output D/A converters with a fast, flexible digital input/output port on one monolithic chip. It is available in two forms, a 44-pin version shown in Figure 1a and a 28-pin version shown in Figure 1b.

### 44-Pin Versions

Each DAC offers flexibility, accuracy and good dynamic performance. The R-2R structure is fabricated from thin-film resistors which are laser-trimmed to achieve 1/2 LSB linearity and guaranteed monotonicity. The output amplifier combines the best features of the bipolar and MOS devices to achieve good dynamic performance and low offset. Settling time is under 10  $\mu$ s and each output can drive a 5 mA, 500 pF load. Short-circuit protection allows indefinite shorts to  $V_{LL}$ ,  $V_{CC}$ ,  $V_{EE}$  and GND. The output and span resistor pins are available separately. This feature allows a user to insert current-boosting elements to increase the drive capability of the system, as well as to overcome parasitics.

Digital circuitry is implemented in CMOS logic. The fast, low power, digital interface allows the AD664 to be interfaced with most microprocessors. Through this interface, the wide variety of features on each chip may be accessed. For example, the input data for each DAC is programmed by way of 4-, 8-, 12- or 16-bit words. The double-buffered input structure of this latch allows all four DACs to be updated simultaneously. A readback feature allows the internal registers to be read back through the same digital port, as either 4-, 8- or 12-bit words. When disabled, the readback drivers are placed in a high impedance (tristate) mode. A TRANSPARENT mode allows the input data to pass straight through both ranks of input registers and appear at the DAC with a minimum of delay. One D/A may be placed in the transparent mode at a time, or all four may be made transparent at once. The MODE SELECT feature allows the output range and mode of the DACs to be selected via the data bus inputs. An internal mode select register stores the selec-

tions. This register may also be read back to check its contents. A RESET-TO-ZERO feature allows all DACs to be reset to 0 volts out by strobing a single pin.

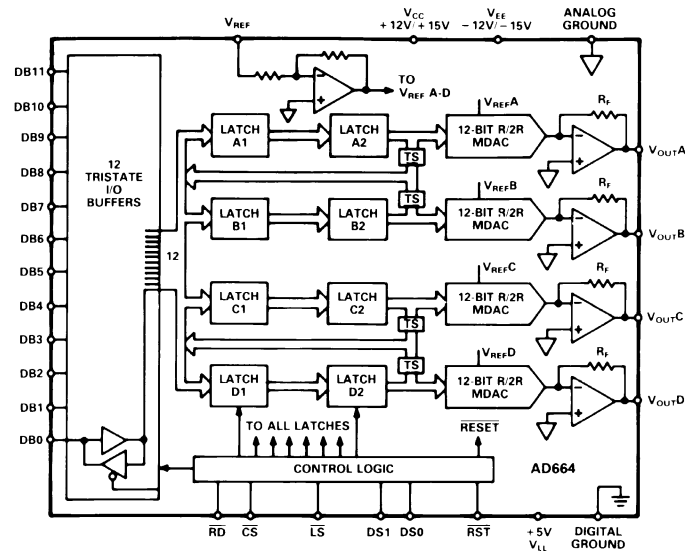

Figure 1b. 28-Pin Block Diagram

### 28-Pin Versions

The 28-pin versions are dedicated versions of the 44-pin AD664. Each offers a reduced set of features from those offered in the 44-pin version. This accommodates the reduced number of package pins available. Data is written and read with 12-bit words only. Output range and mode select functions are also not available in 28-pin versions. As an alternative, users specify either the UNI (unipolar, 0 to  $V_{REF}$ ) models or the BIP (bipolar,  $-V_{REF}$  to  $V_{REF}$ ) models depending on the application requirements. Finally, the transparent mode is not available on the 28-pin versions.

Table I. Transfer Functions

	Mode = UNI	Mode = BIP
Gain = 1	000000000000 = 0 V 100000000000 = $V_{REF}/2$ 111111111111 = $V_{REF} - 1$ LSB	000000000000 = $-V_{REF}/2$ 100000000000 = 0 V 111111111111 = $V_{REF}/2 - 1$ LSB
Gain = 2	000000000000 = 0 V 100000000000 = $V_{REF}$ 111111111111 = $2 \times V_{REF} - 1$ LSB	000000000000 = $V_{REF}$ 100000000000 = 0 V 111111111111 = $+V_{REF} - 1$ LSB

**DEFINITIONS OF SPECIFICATIONS**

**LINEARITY ERROR:** Analog Devices defines linearity error as the maximum deviation of the actual, adjusted DAC output from the ideal analog output (a straight line drawn from 0 to FS - 1 LSB) for any bit combination. This is also referred to as relative accuracy. The AD664 is laser-trimmed to typically maintain linearity errors at less than  $\pm 1/4$  LSB.

**MONOTONICITY:** A DAC is said to be monotonic if the output either increases or remains constant for increasing digital inputs such that the output will always be a nondecreasing function of input. All versions of the AD664 are monotonic over their full operating temperature range.

**DIFFERENTIAL LINEARITY:** Monotonic behavior requires that the differential linearity error be less than 1 LSB both at 25°C as well as over the temperature range of interest. Differential nonlinearity is the measure of the variation in analog value, normalized to full scale, associated with a 1 LSB change in digital input code. For example, for a 10 V full-scale output, a change of 1 LSB in digital input code should result in a 2.44 mV change in the analog output ( $V_{REF} = 10$  V, Gain = 1, 1 LSB =  $10 \text{ V} \times 1/4096 = 2.44$  mV). If in actual use, however, a 1 LSB change in the input code results in a change of only 0.61 mV (1/4 LSB) in analog output, the differential nonlinearity error would be -1.83 mV, or  $-3/4$  LSB.

**GAIN ERROR:** DAC gain error is a measure of the difference between the output span of an ideal DAC and an actual device.

**UNIPOLAR OFFSET ERROR:** Unipolar offset error is the difference between the ideal output (0 V) and the actual output of a DAC when the input is loaded with all “0s” and the MODE is unipolar.

**BIPOLAR ZERO ERROR:** Bipolar zero error is the difference between the ideal output (0 V) and the actual output of a DAC when the input code is loaded with the MSB = “1” and the rest of the bits = “0” and the MODE is bipolar.

**SETTLING TIME:** Settling time is the time required for the output to reach and remain within a specified error band about its final value, measured from the digital input transition.

**CROSSTALK:** Crosstalk is the change in an output caused by a change in one or more of the other outputs. It is due to capacitive and thermal coupling between outputs.

**REFERENCE FEEDTHROUGH:** The portion of an ac reference signal that appears at an output when all input bits are low. Feedthrough is due to capacitive coupling between the reference input and the output. It is specified in decibels at a particular frequency.

**REFERENCE 3 dB BANDWIDTH:** The frequency of the ac reference input signal at which the amplitude of the full-scale output response falls 3 dB from the ideal response.

**GLITCH IMPULSE:** Glitch impulse is an undesired output voltage transient caused by asymmetrical switching times in the switches of a DAC. These transients are specified by their net area (in nV-sec) of the voltage vs. time characteristic.

**PIN CONFIGURATIONS**

28-Pin DIP Package

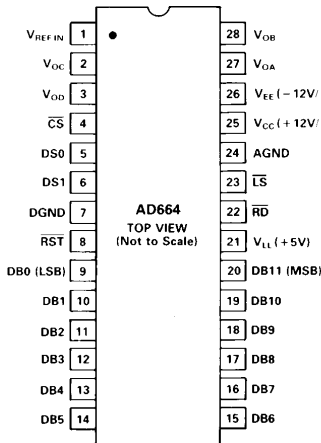

44-Pin Package

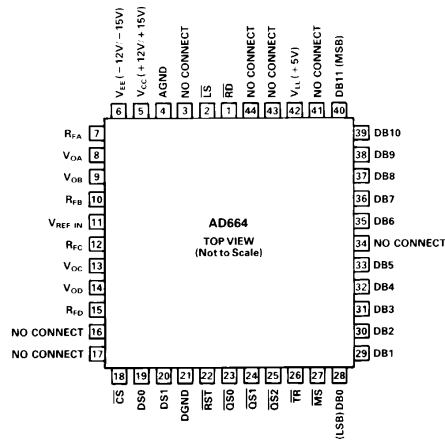

# AD664

## ANALOG CIRCUIT CONSIDERATIONS

### Grounding Recommendations

The AD664 has two pins, designated ANALOG and DIGITAL ground. The analog ground pin is the “high quality” ground reference point for the device. A unique internal design has resulted in low analog ground current. This greatly simplifies management of ground current and the associated induced voltage drops. The analog ground pin should be connected to the analog ground point in the system. The external reference and any external loads should also be returned to analog ground.

The digital ground pin should be connected to the digital ground point in the circuit. This pin returns current from the logic portions of the AD664 circuitry to ground.

Analog and digital grounds should be connected at one point in the system. If there is a possibility that this connection be broken or otherwise disconnected, then two diodes should be connected between the analog and digital ground pins of the AD664 to limit the maximum ground voltage difference.

### Power Supplies and Decoupling

The AD664 requires three power supplies for proper operation.  $V_{LL}$  powers the logic portions of the device and requires +5 volts.  $V_{CC}$  and  $V_{EE}$  power the remaining portions of the circuitry and require +12 V to +15 V and -12 V to -15 V, respectively.  $V_{CC}$  and  $V_{EE}$  must also be a minimum of two volts greater than the maximum reference and output voltages anticipated.

Decoupling capacitors should be used on all power supply pins. Good engineering practice dictates that the bypass capacitors be located as near as possible to the package pins.  $V_{LL}$  should be bypassed to digital ground.  $V_{CC}$  and  $V_{EE}$  should be decoupled to analog ground.

### Driving the Reference Input

The reference input of the AD664 can have an impedance as low as 1.3 k $\Omega$ . Therefore, the external reference voltage must be able to source up to 7.7 mA of load current. Suitable choices include the 5 V AD586, the 10 V AD587 and the 8.192 V AD689.

The architecture of the AD664 derives an inverted version of the reference voltage for some portions of the internal circuitry. This means that the power supplies must be at least 2 V

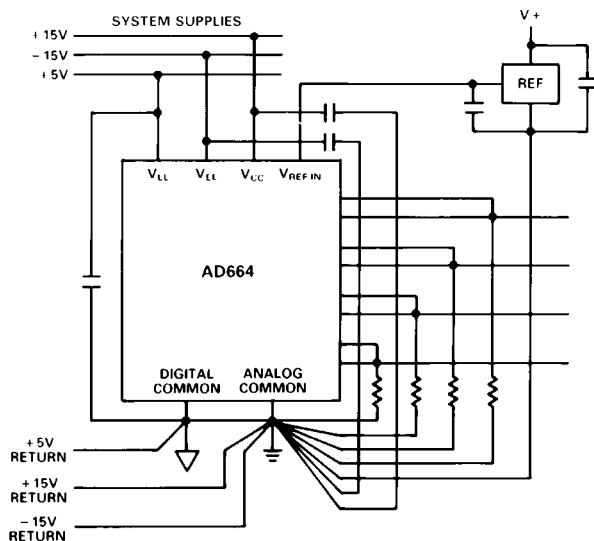

Figure 2. Recommended Circuit Schematic

greater than both the external reference and the inverted external reference.

### Output Considerations

Each DAC output can source or sink 5 mA of current to an external load. Short-circuit protection limits load current to a maximum load current of 40 mA. Load capacitance of up to 500 pF can be accommodated with no effect on stability. Should an application require additional output current, a current boosting element can be inserted into the output loop with no sacrifice in accuracy. Figure 3 details this method.

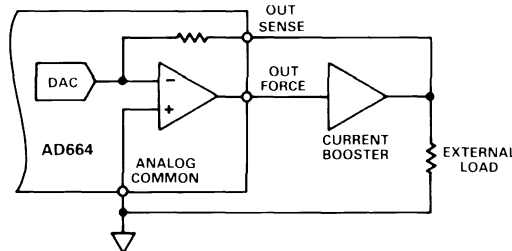

Figure 3. Current-Boosting Scheme

AD664 output voltage settling time is 10  $\mu$ s maximum. Figure 4 shows the output voltage settling time with a fixed 10 V reference, gain = 1 and all bits switched from 1 to 0.

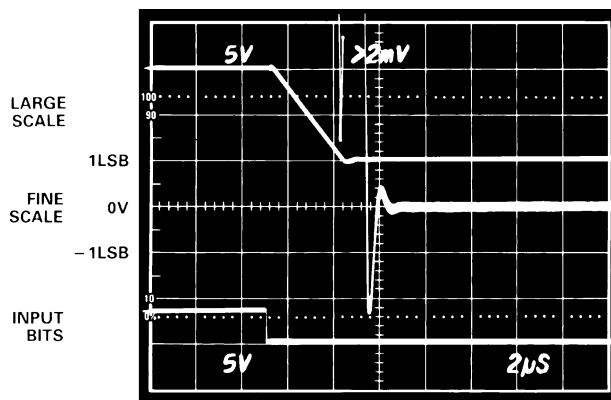

Figure 4. Settling Time; All Bits Switched from On to Off

Alternately, Figure 5 shows the settling characteristics when the reference is switched and the input bits remain fixed. In this case, all bits are “on,” the gain is 1 and the reference is switched from -5 V to +5 V.

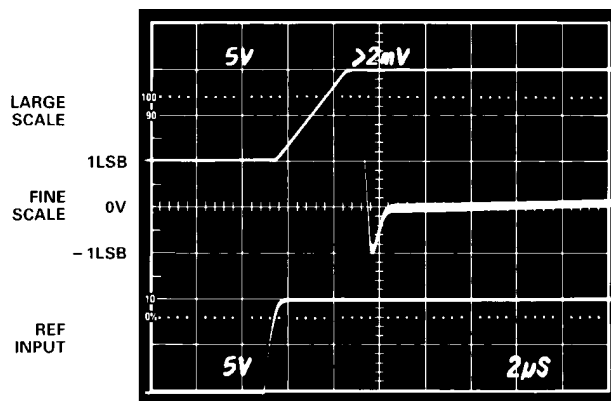

Figure 5. Settling Time; Input Bits Fixed, Reference Switched

### Multiplying Mode Performance

Figure 6 illustrates the typical open-loop gain and phase performance of the output amplifiers of the AD664.

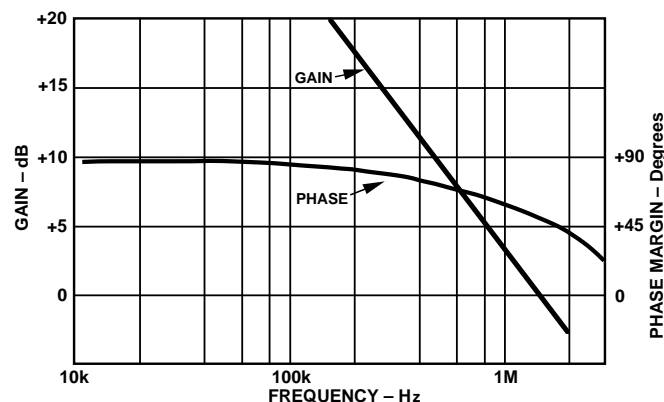

Figure 6. Gain and Phase Performance of AD664 Outputs

### Crosstalk

Crosstalk is a spurious signal on one DAC output caused by a change in the output of one or more of the other DACs. Crosstalk can be induced by capacitive, thermal or load current induced feedthrough. Figure 7 shows typical crosstalk. DAC B is set to output 0 volts. The outputs of DAC A, C and D switch 2 k $\Omega$  loads from 10 V to 0 V. The first disturbance in the output of DAC B is caused by digital feedthrough from the input data lows. The second disturbance is caused by analog feedthrough from the other DAC outputs.

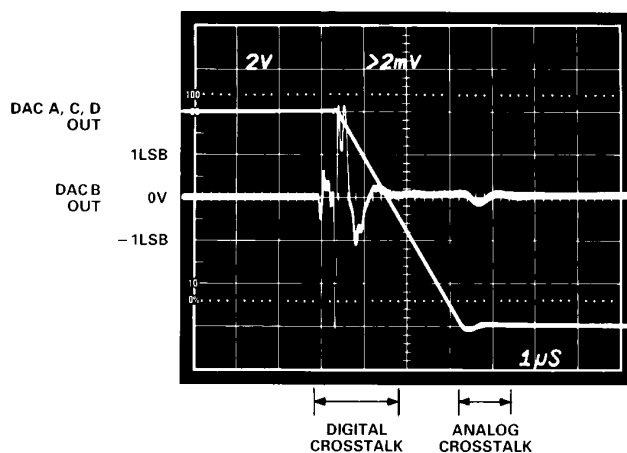

Figure 7. Output Crosstalk

### Output Noise

Wideband output noise is shown in Figure 8. This measurement was made with a 7 MHz noise bandwidth, gain = 1 and all bits on. The total rms noise is approximately one fifth the visual peak-to-peak noise.

### DIGITAL INTERFACE

As Table II shows, the AD664 makes a wide variety of operating modes available to the user. These modes are accessed or programmed through the high speed digital port of the quad DAC. On-board registers program and store the DAC input codes and

the DAC operating mode data. All registers are double-buffered to allow for simultaneous updating of all outputs. Register data may be read back to verify the respective contents. The digital port also allows transparent operation. Data from the input pins can be sent directly through both ranks of latches to the DAC.

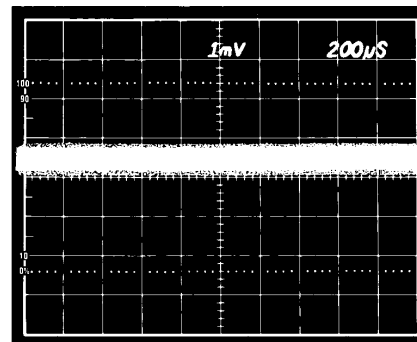

Figure 8. Typical Output Noise

Partial address decoding is performed by the DS0, DS1,  $\overline{QS0}$ ,  $\overline{QS1}$  and  $\overline{QS2}$  address bits.  $\overline{QS0}$ ,  $\overline{QS1}$  and  $\overline{QS2}$  allow the 44-pin versions of the AD664 to be addressed in 4-bit nibble, 8-bit byte or 12-bit parallel words.

The  $\overline{RST}$  pin provides a simple method to reset all output voltages to zero. Its advantages are speed and low software overhead.

### INPUT DATA

In general, two types of data will be input to the registers of the AD664, input code data and mode select data. Input code data sets the DAC inputs while the mode select data sets the gain and range of each DAC.

The versatile I/O port of the AD664 allows many different types of data input schemes. For example, the input code for just one of the DACs may be loaded and the output may or may not be updated. Or, the input codes for all four DACs may be written, and the outputs may or may not be updated.

The same applies for MODE SELECTION. The mode of just one or many of the DACs may be rewritten and the user can choose to immediately update the outputs or wait until a later time to transfer the mode information to the outputs.

A user may also write both input code and mode information into their respective first ranks and then update all second ranks at once.

Finally, transparent operation allows data to be transferred from the inputs to the outputs using a single control line. This feature is useful, for example, in a situation where one of the DACs is used in an A/D converter. The SAR register could be connected directly to a DAC by using the transparent mode of operation. Another use for this feature would be during system calibration where the endpoints of the transfer function of each DAC would be measured. For example, if the full-scale voltages of each DAC were to be measured, then by making all four DACs transparent and putting all "1s" on the input port, all four DACs would be at full-scale. This requires far less software overhead than loading each register individually.

**Table II. AD664 Digital Truth Table**

Function	DS1, DS0	$\overline{LS}$	$\overline{MS}$	$\overline{TR}$	$\overline{QS0}, \overline{1}, \overline{2}^1$	$\overline{RD}$	$\overline{CS}$	$\overline{RST}$
Load 1st Rank (data)								
DACA	00	0	1	1	Select Quad	1	1→0	1
DACB	01	0	1	1	Select Quad	1	1→0	1
DACC	10	0	1	1	Select Quad	1	1→0	1
DACD	11	0	1	1	Select Quad	1	1→0	1
Load 2nd Rank (data)	XX	1	1	1	XXX	1	1→0	1
Readback 2nd Rank (data)	Select D/A	X	1	1	Select Quad	0	1→0	1
Reset	XX	X	X	X	XXX	X	X	0
Transparent <sup>1</sup>								
All DACs	XX	1	1	0	000	1	1→0	1
DACA	00	0	1	0	000	1	1→0	1
DACB	01	0	1	0	000	1	1→0	1
DACC	10	0	1	0	000	1	1→0	1
DACD	11	0	1	0	000	1	1→0	1
Mode Select <sup>1,2</sup>								
1st Rank	XX	0	0	1	00X	1	1→0	1
2nd Rank	XX	1	0	1	XXX	1	1→0	1
Readback Mode <sup>1</sup>	XX	X	0	1	00X	0	1→0	1
Update 2nd Rank and Mode	XX	1	0	0	XXX	1	1→0	1

**NOTES**

X = Don't Care.

<sup>1</sup>For 44-pin versions only. Allow the AD664 to be addressed in 4-bit nibble, 8-bit byte or 12-bit parallel words.

<sup>2</sup>For  $\overline{MS}$ ,  $\overline{TR}$ ,  $\overline{LS} = 0$ , a  $\overline{MS}$  1st write occurs.

The following sections detail the timing requirements for various data loading schemes. All of the timing specifications shown assume  $V_{IH} = 2.4\text{ V}$ ,  $V_{IL} = 0.4\text{ V}$ ,  $V_{CC} = +15\text{ V}$ ,  $V_{EE} = -15\text{ V}$  and  $V_{LL} = +5\text{ V}$ .

**Load and Update One DAC Output**

In this first example, the object is simply to change the output of one of the four DACs on the AD664 chip. The procedure is to select the address bits that indicate the DAC to be programmed, pull LATCH SELECT ( $\overline{LS}$ ) low, pull CHIP SELECT ( $\overline{CS}$ ) low, release  $\overline{LS}$  and then release  $\overline{CS}$ . When  $\overline{CS}$  goes low, data enters the first rank of the input latch. As soon as  $\overline{LS}$  goes high, the data is transferred into the second rank and produces the new output voltage. During this transfer,  $\overline{MS}$ ,  $\overline{TR}$ ,  $\overline{RD}$  and  $\overline{RST}$  should be held high.

**Preloading the First Rank of One DAC**

In this case, the object is to load new data into the first rank of one of the DACs but *not* the output. As in the previous case, the address and data inputs are placed on the appropriate pins.  $\overline{LS}$  is then brought to "0" and then  $\overline{CS}$  is asserted. Note that in this situation, however,  $\overline{CS}$  goes high before  $\overline{LS}$  goes high. The input data is prevented from getting to the second rank and affecting the output voltage.

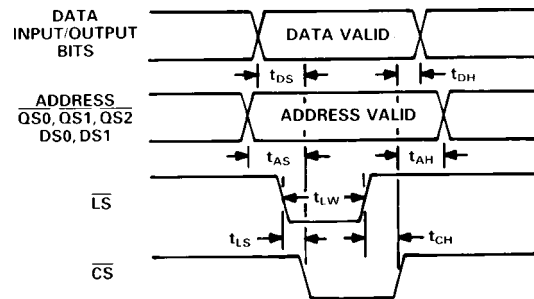

Figure 9a. Update Output of a Single DAC

SYMBOL	25°C MIN (ns)	T <sub>MIN</sub> to T <sub>MAX</sub> MIN (ns)
t <sub>LS</sub> *	0	0
t <sub>DS</sub>	0	0
t <sub>DH</sub>	0	0
t <sub>LW</sub>	60	80
t <sub>CH</sub>	30	50
t <sub>AS</sub>	0	0
t <sub>AH</sub>	0	0

\*FOR t<sub>LS</sub> > 0, THE WIDTH OF  $\overline{LS}$  MUST BE INCREASED BY THE SAME AMOUNT THAT t<sub>LS</sub> IS GREATER THAN 0 ns.

Figure 9b. Update Output of a Single DAC Timing



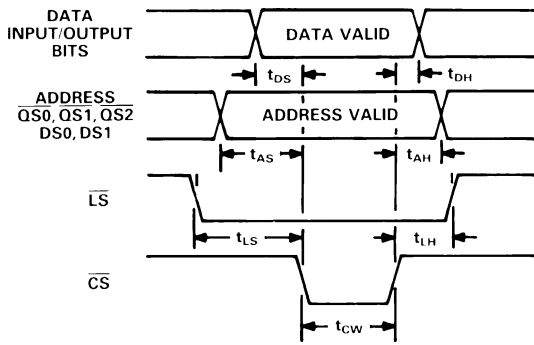

Figure 10a. Preload First Rank of a DAC

SYMBOL	25°C MIN (ns)	T <sub>MIN</sub> to T <sub>MAX</sub> MIN (ns)
t <sub>LS</sub>	0	0
t <sub>LH</sub>	15	15
t <sub>cw</sub>	80	100
t <sub>DS</sub>	0	0
t <sub>DH</sub>	15	15
t <sub>AS</sub>	0	0
t <sub>AH</sub>	15	15

Figure 10b. Preload First Rank of a DAC Timing

This allows the user to “preload” the data to a DAC and strobe it into the output latch at some future time. The user could do this by reproducing the sequence of signals illustrated in the next section.

**Update Second Rank of a DAC**

Assuming that a new input code had previously been placed into the first rank of the input latches, the user can update the output of the DAC by simply pulling CS low while keeping LS, MS, TR, RD and RST high. Address data is not needed in this case. In reality, all second ranks are being updated by this procedure, but only those which receive data different from that already there would manifest a change. Updating the second rank does not change the contents of the first rank.

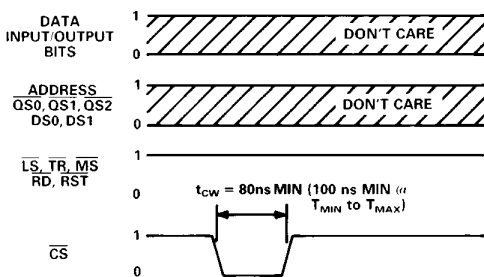

Figure 11. Update Second Rank of a DAC

The same options that exist for individual DAC input loading also exist for multiple DAC input loading. That is, the user can choose to update the first and second ranks of the registers or preload the first ranks and then update them at a future time.

**Preload Multiple First Rank Registers**

The first ranks of the DAC input registers may be preloaded with new input data without disturbing the second rank data. This is done by transferring the data into the first rank by bringing CS low while LS is low. But CS must return high before LS. This prevents the data from the first rank from getting into the second rank. A simple second rank update cycle as shown in Figure 11 would move the “preloaded” information to the DACs.

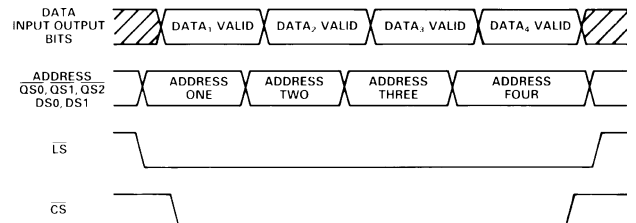

Figure 12. Preload First Rank Registers

**Load and Update Multiple DAC Outputs**

The following examples demonstrate two ways to update all DAC outputs. The first method involves doing all data transfers during one long CS low period. Note that in this case, shown in Figure 13, LS returns high before CS goes high. Data hold time, relative to an address change, is 70 ns. This updates the outputs of all DACs simultaneously.

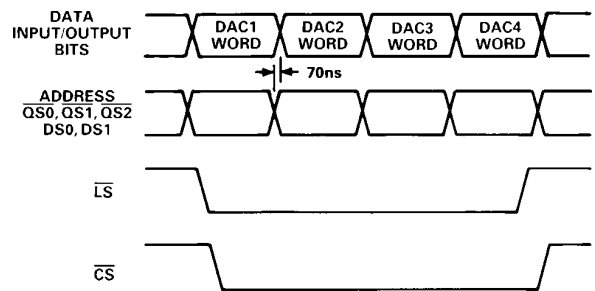

Figure 13. Update All DAC Outputs

The second method involves doing a CS assertion (low) and an LS toggle separately for each DAC. It is basically a series of preload operations (Figure 10). In this case, illustrated in Figure 14, two LS signals are shown. One, labeled LS, goes high before CS returns high. This transfers the “new” input word to the DAC outputs sequentially. The second LS signal, labeled Alternate LS, stays low until CS returns high. Using this sequence loads the first ranks with each “new” input word but doesn’t update the DAC outputs. To then update all DAC outputs simultaneously would require the signals illustrated in Figure 11.

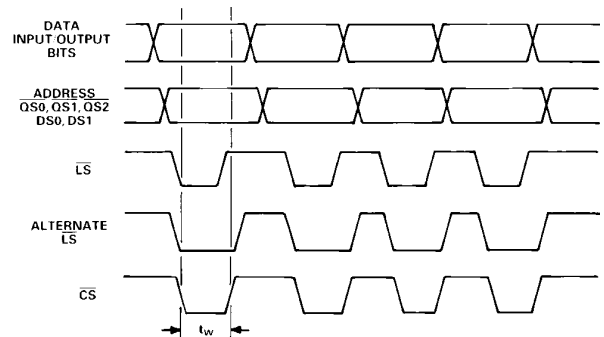

Figure 14. Load and Update Multiple DACs

**SELECTING GAIN RANGE AND MODES (44-PIN VERSIONS)**

The AD664’s mode select feature allows a user to configure the gain ranges and output modes of each of the four DACs. On-board switches take the place of up to eight external relays that would normally be required to accomplish this task. The switches are programmed by the mode select word entered via the data I/O port. The mode select word is eight-bits wide and

# AD664

occupies the topmost eight bits of the input word. The last four bits of the input word are “don’t cares.”

Figure 15 shows the format of the MODE SELECT word. The first four bits determine the gain range of the DAC. When set to be a gain of 1, the output of the DAC spans a voltage of 1 times the reference. When set to a gain of 2, the output of the DAC spans a voltage of 2 times the reference.

The next four bits determine the mode of the DAC. When set to UNIPOLAR, the output goes from 0 to REF or 0 to 2 REF. When the BIPOLAR mode is selected, the output goes from -REF/2 to REF/2 or -REF to REF.

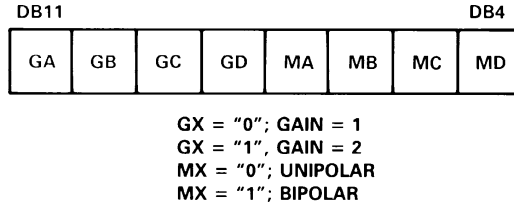

Figure 15. Mode Select Word Format

## Load and Update Mode of One DAC

In this next example, the object is to load new mode information for one of the DACs into the first rank of latches and then immediately update the second rank. This is done by putting the new mode information (8-bit word length) onto the databus. Then  $\overline{MS}$  and  $\overline{LS}$  are pulled low. Following that,  $\overline{CS}$  is pulled low. This loads the mode information into the first rank of latches.  $\overline{LS}$  is then brought high. This action updates the second rank of latches (and, therefore, the DAC outputs). The load cycle ends when  $\overline{CS}$  is brought high.

In reality, this load cycle really updates the modes of all the DACs, but the effect is to only change the modes of those DACs whose mode select information has actually changed.

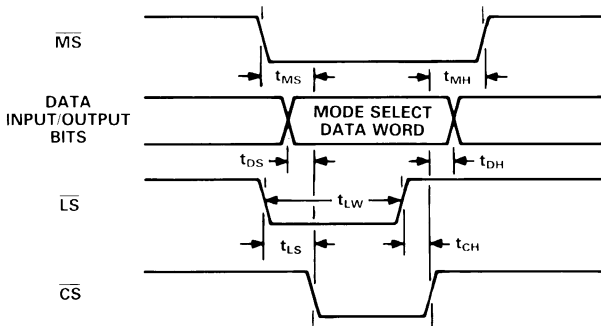

Figure 16a. Load and Update Mode of One DAC

SYMBOL	25°C MIN (ns)	T <sub>MIN</sub> to T <sub>MAX</sub> MIN (ns)
t <sub>MS</sub>	0	0
t <sub>LS*</sub>	0	0
t <sub>DS</sub>	0	0
t <sub>LW</sub>	60	70
t <sub>CH</sub>	70	80
t <sub>DH</sub>	0	0
t <sub>MH</sub>	0	0

\*FOR t<sub>LS</sub> > 0, THE WIDTH OF  $\overline{LS}$  MUST BE INCREASED BY THE SAME AMOUNT THAT t<sub>LS</sub> IS GREATER THAN 0 ns.

Figure 16b. Load and Update Mode of One DAC Timing

## Preloading the Mode Select Register

Mode data can be written into the first rank of the mode select latch without changing the modes currently being used. This feature is useful when a user wants to preload new mode information in anticipation of strobing that in at a future time. Figure 17 illustrates the correct sequence and timing of control signals to accomplish this task.

This allows the user to “preload” the data to a DAC and strobe it into the output latch at some future time. The user could do this by reproducing the sequence of signals illustrated in Figures 17c and 17d.

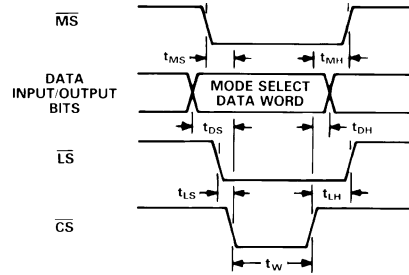

Figure 17a. Preload Mode Select Register

SYMBOL	25°C MIN (ns)	T <sub>MIN</sub> to T <sub>MAX</sub> MIN (ns)
t <sub>MH</sub>	15	15
t <sub>MS</sub>	0	0
t <sub>LS</sub>	0	0
t <sub>DS</sub>	0	0
t <sub>w</sub>	80	100
t <sub>LH</sub>	15	15
t <sub>DH</sub>	15	15

Figure 17b. Preload Mode Select Register Timing

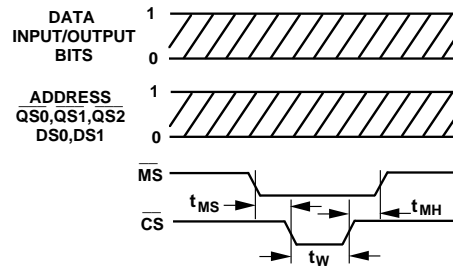

Figure 17c. Update Second Rank of Mode Select Latch

SYMBOL	25°C MIN (ns)	T <sub>MIN</sub> to T <sub>MAX</sub> MIN (ns)
t <sub>MS</sub>	0	0
t <sub>MH</sub>	0	0
t <sub>w</sub>	80	100

Figure 17d. Update Second Rank of Mode Select Latch Timing

## Transparent Operation (44-Pin Versions)

Transparent operation allows data from the inputs of the AD664 to be transferred into the DAC registers without the intervening step of being latched into the first rank of latches. Two modes of transparent operation exist, the “partially transparent” mode and a “fully transparent” mode. In the “partially transparent” mode, one of the DACs is transparent while the remaining three continue to use the data latched into their respective input registers. Both modes require a 12-bit wide input word!

Fully transparent operation can be thought of as a simultaneous load of data from Figure 9a where replacing  $\overline{LS}$  with  $\overline{TR}$  causes all 4 DACs to be loaded at once.

The Fully transparent mode is achieved by asserting lows on  $\overline{QS0}$ ,  $\overline{QS1}$ ,  $\overline{QS2}$ ,  $\overline{TR}$  and  $\overline{CS}$  while keeping  $\overline{LS}$  high in addition to  $\overline{MS}$  and  $\overline{RB}$ . Figure 18a illustrates the necessary timing relationships. Fully transparent operation will also work with  $\overline{TR}$  tied low (enabled).

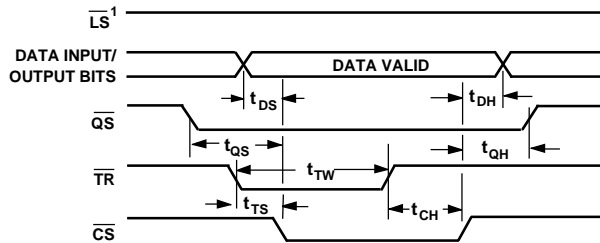

Figure 18a. Fully Transparent Mode

SYMBOL	25°C MIN (ns)	T <sub>MIN</sub> to T <sub>MAX</sub> MIN (ns)
t <sub>AS</sub>	0	0
t <sub>OS</sub>	0	0
t <sub>TS</sub> *	0	0
t <sub>TW</sub>	80	90
t <sub>CH</sub>	90	110
t <sub>DH</sub>	0	0
t <sub>OH</sub>	0	0

\*FOR t<sub>TS</sub> > 0, THE WIDTH OF  $\overline{TR}$  MUST BE INCREASED BY THE SAME AMOUNT THAT t<sub>TS</sub> IS GREATER THAN 0 ns.

Figure 18b. Fully Transparent Mode Timing

Partially transparent operation can be thought of as preloading the first rank in Figure 10a without requiring the additional  $\overline{CS}$  pulse from Figure 11.

The partially transparent mode is achieved by setting  $\overline{CS}$ ,  $\overline{QS0}$ ,  $\overline{QS1}$ ,  $\overline{QS2}$ ,  $\overline{LS}$ , and  $\overline{TR}$  low while keeping  $\overline{RD}$  and  $\overline{MS}$  high. The address of the transparent DAC is asserted on  $\overline{DS0}$  and  $\overline{DS1}$ . Figure 19a illustrates the necessary timing relationships. Partially transparent operation will also work with  $\overline{TR}$  tied low (enabled).

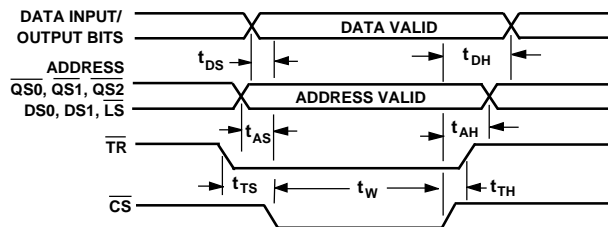

Figure 19a. Partially Transparent

SYMBOL	25°C MIN (ns)	T <sub>MIN</sub> to T <sub>MAX</sub> MIN (ns)
t <sub>DS</sub>	0	0
t <sub>AS</sub>	0	0
t <sub>TS</sub>	0	0
t <sub>W</sub>	90	110
t <sub>DH</sub>	15	15
t <sub>AH</sub>	15	15
t <sub>TH</sub>	15	15

Figure 19b. Partially Transparent Mode Timing

**OUTPUT DATA**

Two types of outputs may be obtained from the internal data registers of the AD664 chip, mode select and DAC input code data. Readback data may be in the same forms in which it can be entered; 4-, 8-, and 12-bit wide words (12 bits only for 28-pin versions).

**DAC Data Readback**

DAC input code readback data is obtained by setting the address of the DAC ( $\overline{DS0}$ ,  $\overline{DS1}$ ) and Quads ( $\overline{QS0}$ ,  $\overline{QS1}$ ,  $\overline{QS2}$ ) on the address pins and bringing the  $\overline{RD}$  and  $\overline{CS}$  pins low. The timing diagram for a DAC code readback operation appears in Figure 20.

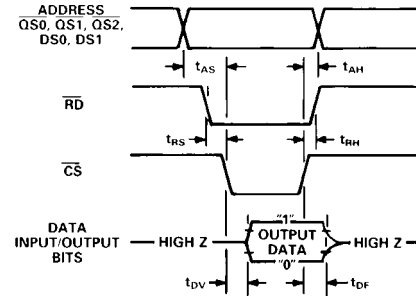

Figure 20a. DAC Input Code Readback

SYMBOL	25°C MIN (ns)	T <sub>MIN</sub> to T <sub>MAX</sub> MIN (ns)
t <sub>AS</sub>	0	0
t <sub>RS</sub>	0	0
t <sub>DV</sub>	150	180
t <sub>DF</sub>	60	75
t <sub>AH</sub>	0	0
t <sub>RH</sub>	0	0

Figure 20b. DAC Input Code Readback Timing

**Mode Data Readback**

Mode data is read back in a similar fashion. By setting  $\overline{MS}$ ,  $\overline{QS0}$ ,  $\overline{QS1}$ ,  $\overline{RD}$  and  $\overline{CS}$  low while setting  $\overline{TR}$  and  $\overline{RST}$  high, the mode select word is presented to the I/O port pins. Figure 21 shows the timing diagram for a readback of the mode select data register.

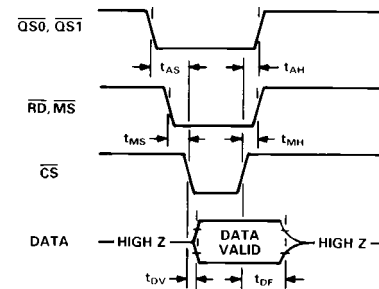

Figure 21a. Mode Data Readback

SYMBOL	25°C MIN (ns)	T <sub>MIN</sub> to T <sub>MAX</sub> MIN (ns)
t <sub>AS</sub>	0	0
t <sub>MS</sub>	0	0
t <sub>DV</sub>	150	180
t <sub>DF</sub>	60	75
t <sub>AH</sub>	0	0
t <sub>MH</sub>	0	0

Figure 21b. DAC Mode Readback Timing

# AD664

## Output Loads

Readback timing is tested with the output loads shown in Figure 22.

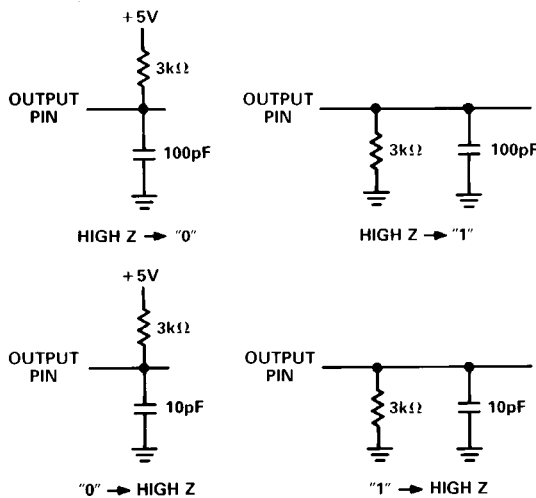

Figure 22. Output Loads

## Asynchronous Reset Operation

The asynchronous reset signal shown in Figure 23 may be asserted at any time. A minimum pulse width ( $t_{RW}$ ) of 90 ns is required. The reset feature is designed to return all DAC outputs to 0 volts regardless of the mode or range selected. In the 44-pin versions, the modes are reset to unipolar 10 V span (gain of 1), and the input codes are rewritten to be “0s.” Previous DAC code and mode information is erased.

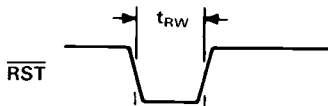

Figure 23a. Asynchronous Reset Operation

SYMBOL	25°C MIN (ns)	T <sub>MIN</sub> to T <sub>MAX</sub> MIN (ns)
$t_{RW}$	80	100

Figure 23b. Asynchronous Reset Operation Timing

In the 28-pin versions of the AD664, the mode remains unchanged, the appropriate input code is rewritten to reset the output voltage to 0 volts. As in the 44-pin versions, the previous input data is erased.

At power-up, an AD664 may be activated in either the read or write modes. While at the device level this will not produce any problems, at the system level it may. Analog Devices recommends the addition of a simple power-on reset scheme to any system where the possibility of an unknown start-up state could be a problem. The simplest version of this scheme is illustrated in Figure 24.

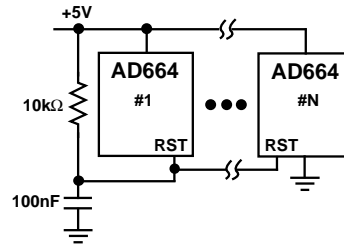

Figure 24. Power-On Reset

It is obvious from inspection that the scheme shown in Figure 24 is only appropriate for systems in which the  $\overline{RST}$  is otherwise not used. Should the user wish to use the  $\overline{RST}$  pin, an additional logic gate may be included to combine the power-on reset with the reset signal.

## INTERFACING THE AD664 TO MICROPROCESSORS

The AD664 is easy to interface with a wide variety of popular microprocessors. Common architectures include processors with dedicated 8-bit data and address buses, an 8-bit bus over which data and address are multiplexed, an 8-bit data and 16-bit address partially muxed, and separate 16-bit data and address buses.

AD664 addressing can be accomplished through either memory-mapped or I/O techniques. In memory-mapped schemes, the AD664 appears to the host microprocessor as RAM memory. Standard memory addressing techniques are used to select the AD664. In the I/O schemes, the AD664 is treated as an external I/O device by the host. Dedicated I/O pins are used to address the AD664.

### MC6801 Interface

In Figures 25a–25d, we illustrate a few of the various methods that can be used to connect an AD664 to the popular MC6801 microprocessor. In each of these cases, the MC6801 is intended to be configured in its expanded, nonmultiplexed mode of operation. In this mode, the MC6801 can address 256 bytes of external memory over 8-bit data (Port 3) and 8-bit address (Port 4) buses. Eight general-purpose I/O lines (Port 1) are also available. On-board RAM and ROM provide program and data storage space.

In Figure 25a, the three least significant address bits (P40, P41 and P42) are employed to select the appropriate on-chip addresses for the various input registers of the AD664. Three I/O lines (P17, P16 and P15) are used to select various operating features of the the AD664. IOS and E(nable) are combined to produce an appropriate  $\overline{CS}$  signal. This addressing scheme leaves the five most significant address bits and five I/O lines free for other tasks in the system.

Figure 25b shows another way to interface an AD664 to the MC6801. Here we’ve used the six least significant address lines to select AD664 features and registers. This is a purely memory-mapped scheme while the one illustrated in Figure 25a uses some memory-mapping as well as some dedicated I/O pins. In Figure 25b, two address lines and all eight I/O lines remain free for other system tasks.

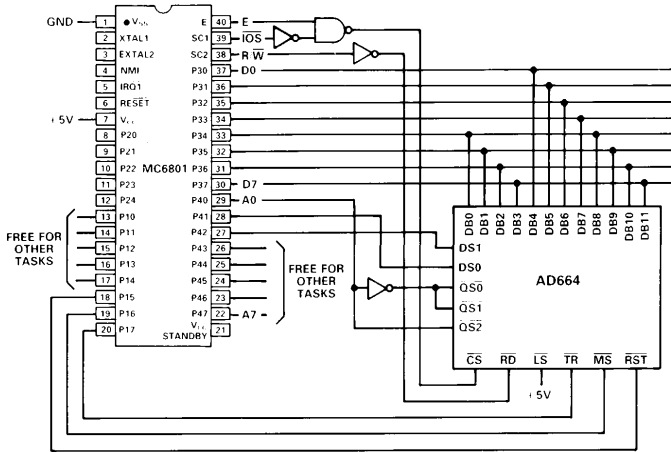

Figure 25a. Simple AD664 to MC6801 Interface

Expansion of the scheme employed in Figure 25a results in that shown in Figure 25c. Here, two AD664s are connected to an MC6801, providing a total of eight 12-bit, software programmable DACs. Again, the three least significant bits of address are used to select the on-chip registers of the AD664. IOS and E, as well as a fourth address bit, are decoded to provide the appropriate CS signals. Four address and five I/O lines remain uncommitted.

A slightly more sophisticated approach to system expansion is illustrated in Figure 25d. Here, a 74LS138 (1-of-8 decoder) is used to address one of the eight AD664s connected to the MC6801. The three least significant address bits are used to select on-chip register and DAC. The next three address bits are used to select the appropriate AD664. IOS and E gate the 74LS138 output.

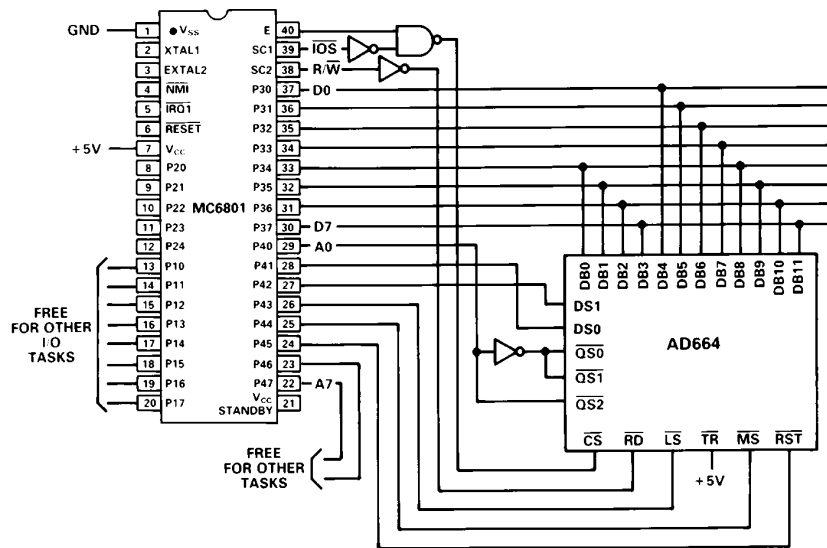

Figure 25b. Alternate AD664 to MC6801 Interface

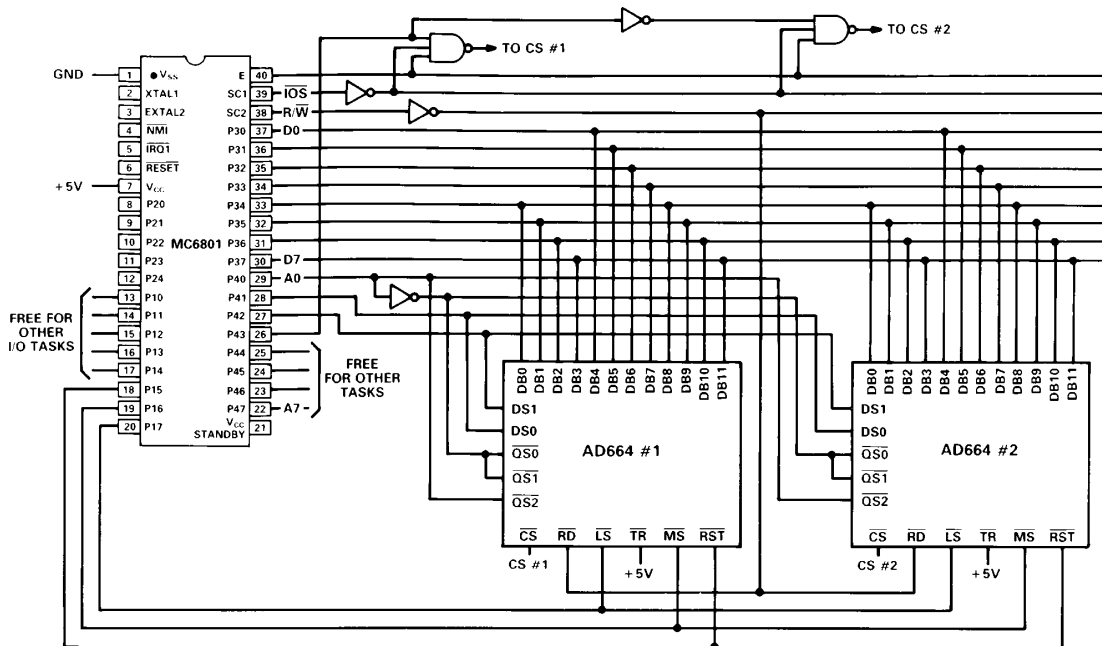

Figure 25c. Interfacing Two AD664s to an MC6801

# AD664

The schemes in Figure 25 illustrate some of the trade-offs which a designer may make when configuring a system. For example, the designer may use I/O lines instead of address bits or vice versa. This decision may be influenced by other I/O tasks or system expansion requirements. He/she can also choose to implement only a subset of the features available. Perhaps the  $\overline{RST}$  pin isn't really needed. Tying that input pin to  $V_{LOGIC}$  frees up another I/O or address bit. The same consideration applies to mode select. In all of these cases  $\overline{TR}$  is shown tied to  $V_{LOGIC}$ , because the MC6801 cannot provide the 12-bit-wide input word required for the transparent mode. In situations where transparent operation isn't required, and mode select is also not needed, the designer may consider specifying the DIP version of the device (either the UNI or BIP version).

Each of the schemes illustrated in Figure 25 operates with an MC6801 at clock rates up to and including 1.5 MHz. Similar schemes can be derived for other 8-bit microprocessors and microcontrollers such as the 8051/8086/8088/6502, etc. One such scheme developed for the 8051/AD664 is illustrated in Figure 26.

### 8051 Interface

Figure 26 shows the AD664 combined with an 8051  $\mu$ controller chip. Three LSBs of address provide the quad and DAC select signals. Control signals from Port 1 select various operating modes such as readback, mode select and reset as well as providing the  $\overline{LS}$  signal. Read and write signals from the 8051 are decoded to provide the  $\overline{CS}$  signal.

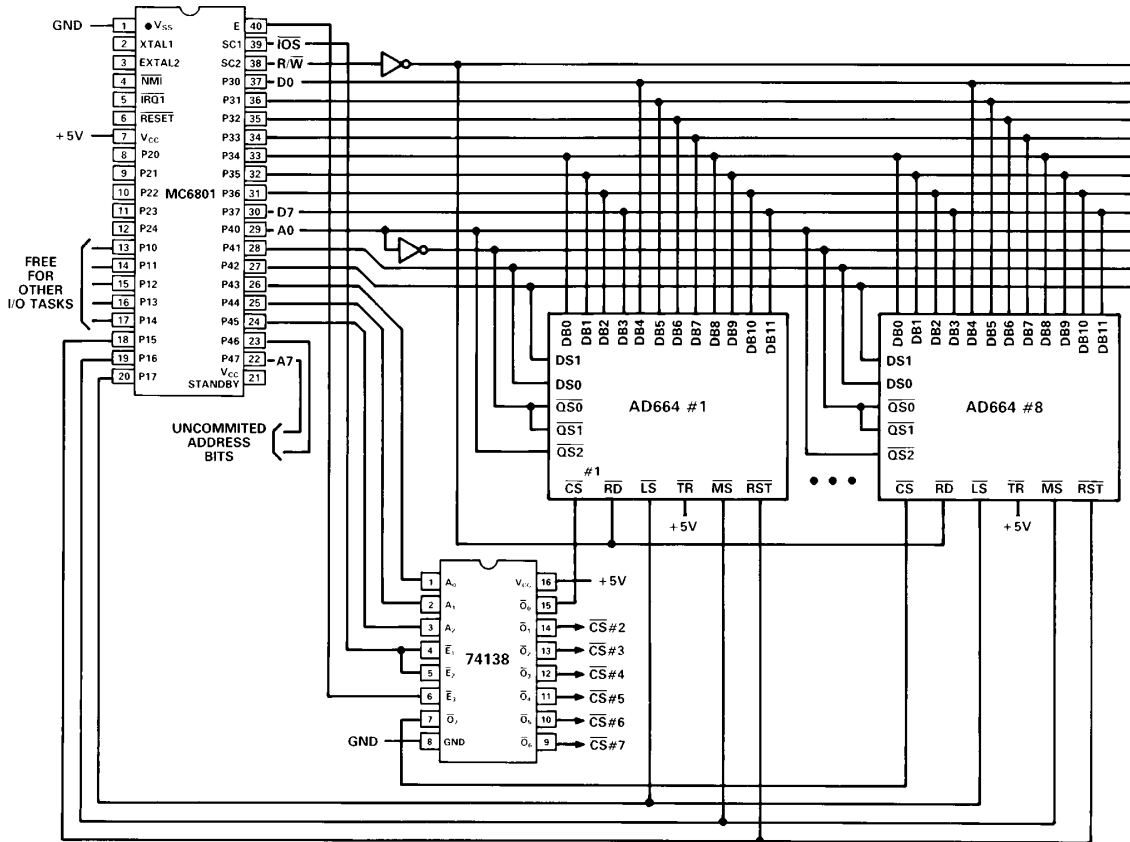

Figure 25d. Interfacing Eight AD664s to an MC6801

## IBM PC\* Interface

Figure 27 illustrates a simple interface between an IBM PC and an AD664. The three least significant address bits are used to select the Quad and DAC. The next two address bits are used for  $\overline{LS}$  and  $\overline{MS}$ . In this scheme, a 12-bit input word requires two load cycles, an 8-bit word and a 4-bit word. Another write

is required to transfer the word or words previously written to the second rank. A 12-bit-wide word again requires at least two read cycles; one for the 8 MSBs and four for the LSBs. The page select signal produces a  $\overline{CS}$  strobe for any address from 300H to 31FH.

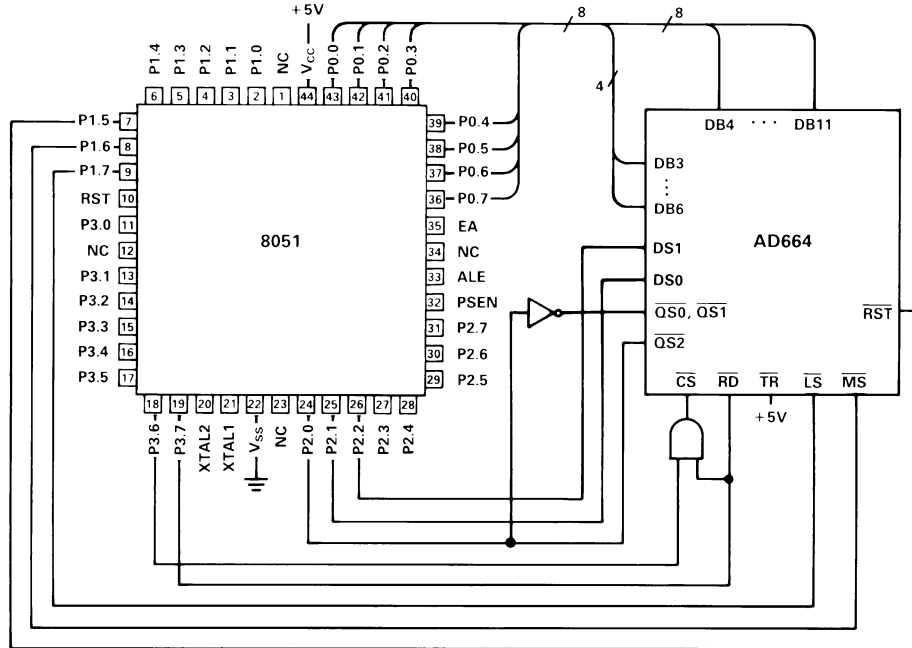

Figure 26. AD664 to 8051 Interface

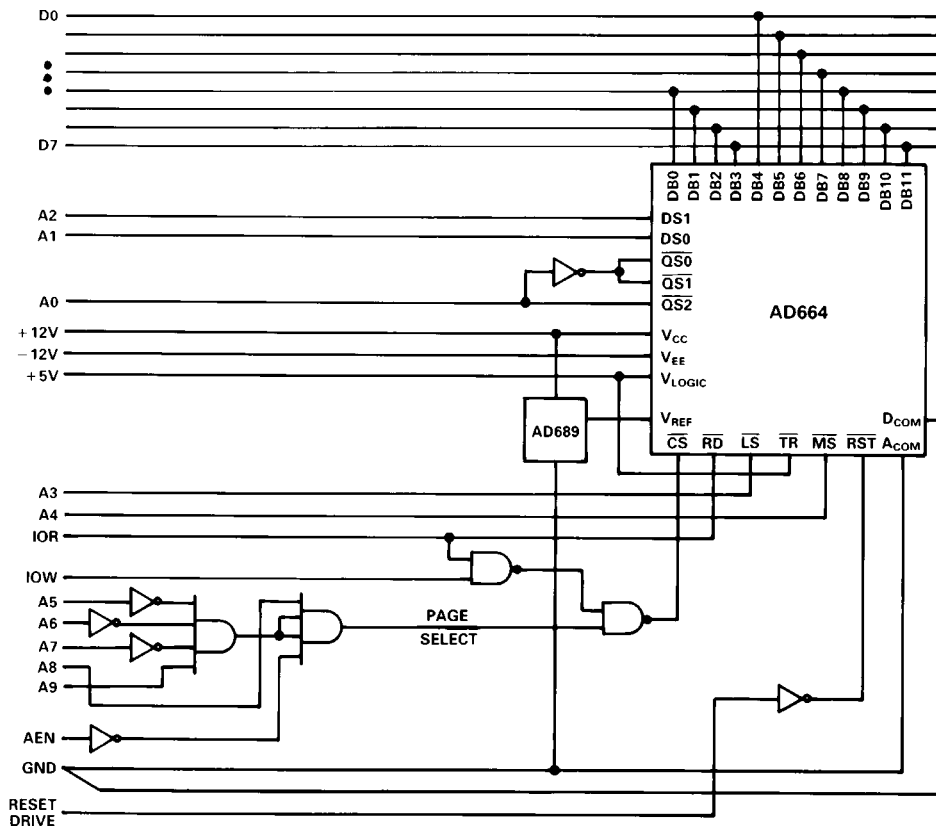

Figure 27. AD664 to IBM PC Interface

\*IBM PC is a trademark of International Business Machines Corp.

# AD664

Table III details the memory locations and addresses used by this interface.

**Table III. IBM PC Memory Map**

HEX	A9	A8	A7	A6	A5	A4	A3	A2	A1	A0	REGISTER SELECTED
300	1	1	0	0	0	0	0	0	0	0	Illegal Address
301	↓	↓	↓	↓	↓	↓	↓	0	0	1	Mode Select, 1st Rank
302	↓	↓	↓	↓	↓	↓	↓	0	1	0	Illegal Address
303	↓	↓	↓	↓	↓	↓	↓	0	1	1	Mode Select, 1st Rank
304	↓	↓	↓	↓	↓	↓	↓	1	0	0	Illegal Address
305	↓	↓	↓	↓	↓	↓	↓	1	0	1	Mode Select, 1st Rank
306	↓	↓	↓	↓	↓	↓	↓	1	1	0	Illegal Address
307	↓	↓	↓	↓	↓	↓	▼	1	1	1	Mode Select, 1st Rank
308	↓	↓	↓	↓	↓	↓	1	0	0	0	Mode Select, 2nd Rank
309	↓	↓	↓	↓	↓	↓	↓	0	0	1	
30A	↓	↓	↓	↓	↓	↓	↓	0	1	0	
30B	↓	↓	↓	↓	↓	↓	↓	0	1	1	
30C	↓	↓	↓	↓	↓	↓	↓	1	0	0	
30D	↓	↓	↓	↓	↓	↓	↓	1	0	1	
30E	↓	↓	↓	↓	↓	↓	↓	1	1	0	
30F	↓	↓	↓	↓	↓	▼	▼	1	1	1	▼
310	↓	↓	↓	↓	↓	1	0	0	0	0	DAC A, 4 LSBs, 1st Rank
311	↓	↓	↓	↓	↓	↓	↓	0	0	1	DAC A, 8 MSBs, 1st Rank
312	↓	↓	↓	↓	↓	↓	↓	0	1	0	DAC B, 4 LSBs, 1st Rank
313	↓	↓	↓	↓	↓	↓	↓	0	1	1	DAC B, 8 MSBs, 1st Rank
314	↓	↓	↓	↓	↓	↓	↓	1	0	0	DAC C, 4 LSBs, 1st Rank
315	↓	↓	↓	↓	↓	↓	↓	1	0	1	DAC C, 8 MSBs, 1st Rank
316	↓	↓	↓	↓	↓	↓	↓	1	1	0	DAC D, 4 LSBs, 1st Rank
317	↓	↓	↓	↓	↓	↓	▼	1	1	1	DAC D, 8 MSBs, 1st Rank
318	↓	↓	↓	↓	↓	↓	1	0	0	0	2nd Rank
319	↓	↓	↓	↓	↓	↓	↓	0	0	1	↓
31A	↓	↓	↓	↓	↓	↓	↓	0	1	0	
31B	↓	↓	↓	↓	↓	↓	↓	0	1	1	
31C	↓	↓	↓	↓	↓	↓	↓	1	0	0	
31D	↓	↓	↓	↓	↓	↓	↓	1	0	1	
31E	↓	↓	↓	↓	↓	↓	↓	1	1	0	
31F	▼	▼	▼	▼	▼	▼	▼	1	1	1	▼

Note: Shaded registers are readable.



The following IBM PC Basic routine produces four output voltage ramps from one AD664. Line numbers 10 through 70 define the hardware addresses for the first and second ranks of DAC registers as well as the first and second ranks of the mode select register. Program variables are initialized in line numbers 110 through 130. Line number 170 writes "0s" out to the first rank and, then, the second rank of the mode select register.

Line numbers 200 through 320 calculate output voltages. Finally line numbers 410 through 450 update the first, then the second ranks of the DAC input registers. Hardware registers may be read with the "INP" instruction. For example, the contents of the DAC A register may be accessed with the following command: Line# A = INP(DACA).

```

5          REM----AD664 LISSAJOUS PATTERNS----
10         REM ---ASSIGN HARDWARE ADDRESSES---
20         DACA = 785
30         DACB = 787
40         DACC = 789
50         DACD = 791
60         DAC2ND = 792
70         MODE1 = 769: MODE2 = 776
80         REM
90         REM
100        REM ---INITIALIZE VARIABLES---
110       X = 0: Y1 = 128: Y2 = 64: Y3 = 32
120       CX = 1: CY1 = 1: CY2 = -1: CY3 = 1
130       FX = 9: FY1 = 5: FY2 = 13: FY3 = 15
140       REM
150       REM
160       REM ---INITIALIZE MODES AND GAINS---
170       OUT MODE1,0: OUT MODE2,0
180       REM
190       REM
200       REM ---CALCULATE VARIABLES---
210       X = X + FX*CX
220       Y1 = Y1 + FY1*CY1
230       Y2 = Y2 + FY2*CY2
240       Y3 = Y3 + FY3*CY3
250       IF X > 255 THEN X = 255: CX = -1: GOTO 270
260       IF X < 0 THEN X = 0: CX = 1
270       IF Y1 > 255 THEN Y1 = 255: CY1 = -1: GOTO 290
280       IF Y1 < 0 THEN Y1 = 0: CY1 = 1
290       IF Y2 > 255 THEN Y2 = 255: CY2 = -1 GOTO 310
300       IF Y2 < 0 THEN Y2 = 0: CY2 = -1
310       IF Y3 > 255 THEN Y3 = 255: CY3 = -1: GOTO 400
320       IF Y3 < 0 THEN Y3 = 0: CY3 = 1
330       REM
340       REM
400       REM ---SEND DAC DATA---
410       OUT DACA,X
420       OUT DACB,Y1
430       OUT DACC,Y2
440       OUT DACD,Y3
450       OUT DAC2ND,0
500       REM
510       REM
520       REM ---LOOP BACK---
530       GOTO 210

```



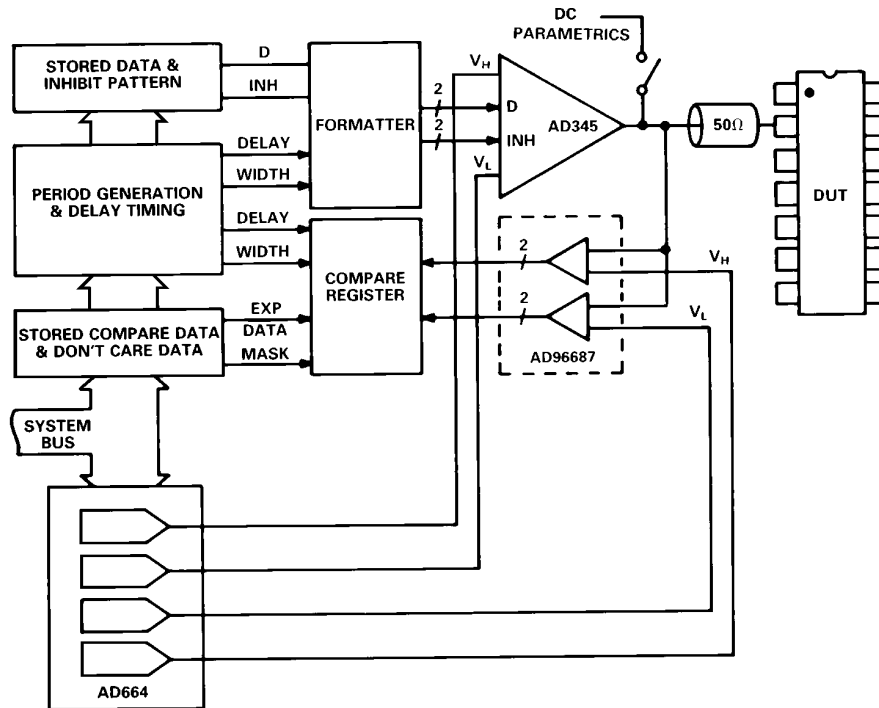

Figure 29. AD664 in "Tester-per-Pin" Architecture

**APPLICATIONS OF THE AD664**  
**"Tester-Per-Pin" ATE Architecture**

Figure 29 shows the AD664 used in a single channel of a digital test system. In this scheme, the AD664 supplies four individual output voltages. Two are provided to the  $V_{HIGH}$  and  $V_{LOW}$  inputs of the AD345 pin driver I.C. to set the digital output levels. Two others are routed to the inputs of the AD96687 dual comparator to supply reference levels of the readback features. This approach can be replicated to give as many channels of stimulus/readback as the tester has pins. The AD664 is a particularly appropriate choice for a large-scale system because the low power requirements (under 500 mW) ease power supply and cooling requirements. Analog ground currents of 600  $\mu A$  or less make the ground current management task simpler. All DACs can be driven from the same system reference and will track over time and temperature. Finally, the small board area required by the AD664 (and AD345 and AD96687) allows a high functional density.

**X-Y Plotters**

Figure 30 is a block diagram of the control section of a microprocessor-controlled X-Y pen plotter. In this conceptual exercise, two of the DACs are used for the X-channel drive and two are used for the Y-channel drive. Each provides either the coarse or fine movement control for its respective channel. This approach offers increased resolution over some other approaches.

A designer can take advantage of the reset feature of the AD664 in the following manner. If the system is designed such that the "HOME" position of the pen (or galvanometer, beam, head or similar mechanism) results when the outputs of all of the DACs are at zero, then no system software is required to home the pen. A simple reset signal is sufficient.

Similarly, the transparent feature could be used to the same end. One code can be sent to all DACs at the same time to send the pen to the home position. Of course, this would require

some software where the previous example would require only a single reset strobe signal!

Drawing scaling can be achieved by taking advantage of the AD664's software programmable gain settings. If, for example, an "A" size drawing is created with gain settings of 1, then a "C" size drawing can be created by simply resetting all DAC gains to 2 and redrawing the object. Conversely, a "C" size drawing created with gains of 2 can be reduced to "A" size simply by changing the gains to 1 and redrawing. The same principle applies for conversion from "B" size to "D" size or "D" size to "B" size. The multiplying capability of the AD664 provides another scaling option. Changing the reference voltage provides a proportional change in drawing size. Inverting the reference voltage would invert the drawing.

Swapping digital input data from the X channel to the Y channel would rotate the drawing 90 degrees.

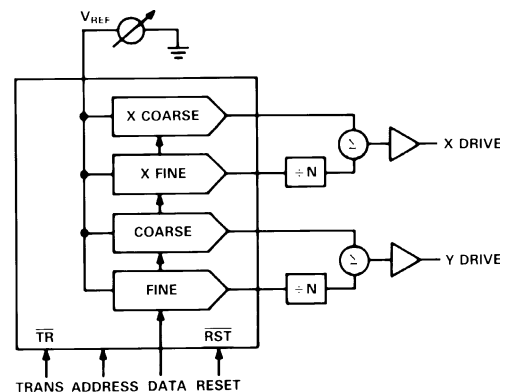

Figure 30. X-Y Plotter Block Diagram

# AD664

## ORDERING GUIDE

Model <sup>1</sup>	Temperature Range	Output Range	Gain Error	Linearity Error	Package Options <sup>2</sup>
AD664JN-UNI	0°C to +70°C	0 to +V <sub>REF</sub>	±7 LSB	±0.75 LSB	N-28
AD664JN-BIP	0°C to +70°C	-V <sub>REF</sub> to +V <sub>REF</sub>	±7 LSB	±0.75 LSB	N-28
AD664JP	0°C to +70°C	Programmable	±7 LSB	±0.75 LSB	P-44A
AD664KN-UNI	0°C to +70°C	0 to +V <sub>REF</sub>	±5 LSB	±0.5 LSB	N-28
AD664KN-BIP	0°C to +70°C	-V <sub>REF</sub> to +V <sub>REF</sub>	±5 LSB	±0.5 LSB	N-28
AD664KP	0°C to +70°C	Programmable	±5 LSB	±0.5 LSB	P-44A
AD664AD-UNI	-40°C to +85°C	0 to +V <sub>REF</sub>	±7 LSB	±0.75 LSB	D-28
AD664AD-BIP	-40°C to +85°C	-V <sub>REF</sub> to +V <sub>REF</sub>	±7 LSB	±0.75 LSB	D-28
AD664AJ	-40°C to +85°C	Programmable	±7 LSB	±0.75 LSB	J-44
AD664BD-UNI	-40°C to +85°C	0 to +V <sub>REF</sub>	±5 LSB	±0.5 LSB	D-28
AD664BD-BIP	-40°C to +85°C	-V <sub>REF</sub> to +V <sub>REF</sub>	±5 LSB	±0.5 LSB	D-28
AD664BJ	-40°C to +85°C	Programmable	±5 LSB	±0.5 LSB	J-44
AD664BE	-40°C to +85°C	Programmable	±5 LSB	±0.5 LSB	E-44A
AD664SD-UNI	-55°C to +125°C	0 to +V <sub>REF</sub>	±7 LSB	±0.75 LSB	D-28
AD664SD-BIP	-55°C to +125°C	-V <sub>REF</sub> to +V <sub>REF</sub>	±7 LSB	±0.75 LSB	D-28
AD664TD-UNI	-55°C to +125°C	0 to +V <sub>REF</sub>	±5 LSB	±0.5 LSB	D-28
AD664TD-BIP	-55°C to +125°C	-V <sub>REF</sub> to +V <sub>REF</sub>	±5 LSB	±0.5 LSB	D-28

### NOTES

<sup>1</sup>For details on grade and package offerings screened in accordance with MIL-STD-883, refer to the Analog Devices Military Products Databook or current AD664/883B data sheet.

<sup>2</sup>D = Ceramic DIP; E = Leadless Ceramic Chip Carrier; J = Leaded Chip Carrier; N = Plastic DIP; P = Plastic Leaded Chip Carrier.

## OUTLINE DIMENSIONS

Dimensions shown in inches and (mm).

**D-28**  
28-Pin Ceramic DIP Package

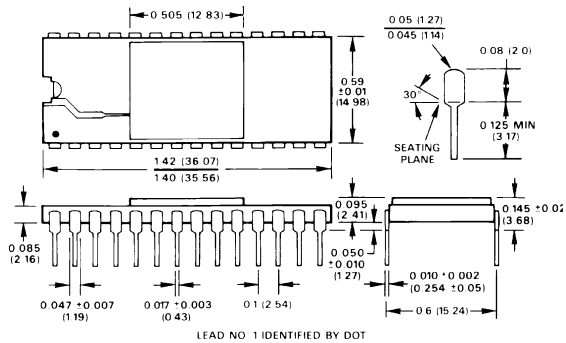

**N-28**  
28-Lead Plastic DIP

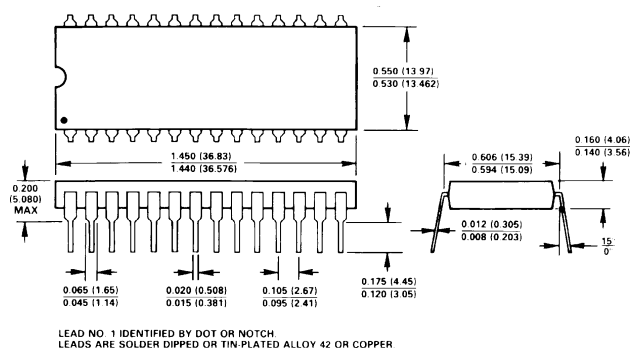

**E-44A**  
44-Pin LCC Package

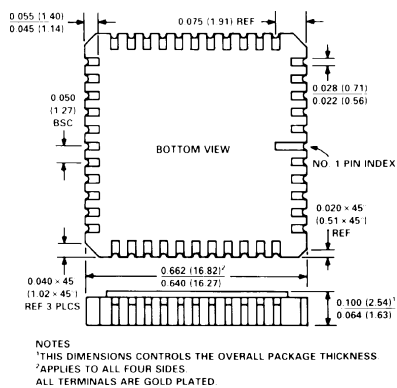

**J-44**  
J-Leaded Chip Carrier

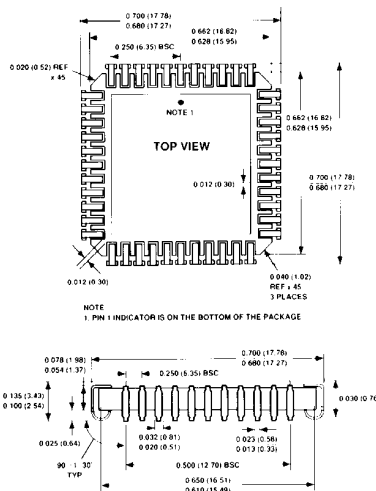

**P-44A**  
44-Lead Plastic Leaded Chip Carrier (PLCC)

